



# Spare Parts for Combi Ovens



Spare parts suitable for

# LAINOX

# 2018

Find the complete and up-to-date range of products in our GEV Webshop



## heating elements

## immersion heating elements

## 3 hole flange ø57.5mm

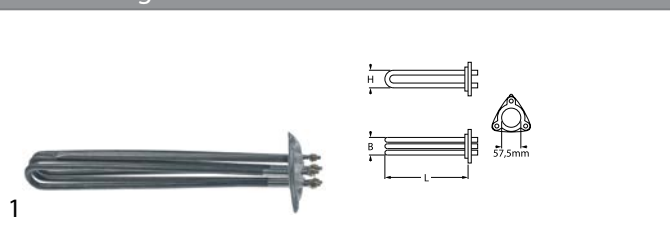

<b>GEV No.</b>	415021	<b>Ref. No.</b>	50303250 LAR50303250
----------------	--------	-----------------	-------------------------

**description** heating element 6000W 230V mounting ø 57.5mm heating circuits 3 L 343mm W 37mm H 50mm number of thermostat sleeves 1 thermostat sleeves ø 7mm length thermostat sleeves 294mm thermostat sleeve not clinging tube ø 8.5mm hole distance 72mm hole ø 8mm connection M5 3 hole flange

**For models:** FV03, FV06, ME05, ME10, ME15, ME20, ME21, ME24, ME40, MG20, MME05, MME10, MME40

**spare parts for** 415021

	<b>GEV No.</b>	510409	<b>Ref. No.</b>	70045010 LA70045010 LAR70045010 R70045010
--	----------------	--------	-----------------	--

O-ring EPDM thickness 5.34mm ID ø 56.52mm Qty 1 pcs

**accessories for** 415021

	<b>GEV No.</b>	550002	<b>Ref. No.</b>	—
--	----------------	--------	-----------------	---

tension strap H 10mm L 21mm W 10mm hole ø 6.5mm for heating element

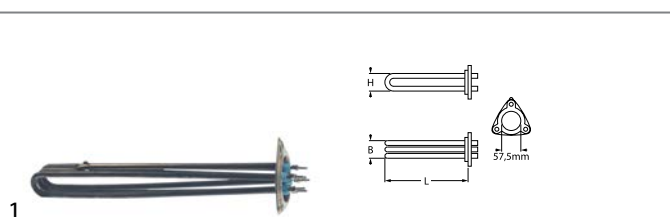

<b>GEV No.</b>	418084	<b>Ref. No.</b>	6003290
----------------	--------	-----------------	---------

**description** heating element 7599W 230V mounting ø 57.5mm heating circuits 3 L 340mm W 36mm H 42mm number of thermostat sleeves 1 thermostat sleeves ø 7mm length thermostat sleeves 270mm thermostat sleeve clinging tube ø 8.5mm hole distance 72mm hole ø 8mm connection M4 3 hole flange immersion heater

**For models:** VE102MX

## with round flange ø57.5mm



<b>GEV No.</b>	415849	<b>Ref. No.</b>	65020390 65020400 65020420 65020421 LA65020421 LAR65020390 LAR65020400 LAR65020420 LAR65020421
----------------	--------	-----------------	--

**description** heating element 15000W 230V heating circuits 3 mounting ø 57.5mm L 530mm W 45mm H 30mm round flange connection M4 immersion heater tube ø 8.5mm connection length 15mm thermostat sleeves ø 7mm number of thermostat sleeves 1 length thermostat sleeves 272mm thermostat sleeve eccentric, clinging

**For models:** EMT20P, EMT21P, GEMT20P, GEMT20S, GEMT20T, GEMT20X, GEMT21P, GEMT21S, GEMT21T, GEMT21X, GEMT40P, GEMT40S, GEMT40T, GEMT40X, GSE201N, HME102P, HME102S, HME102T, HME102X, HME201P, HME201S, HME201T, HME201X, HME202P, HME202S, HME202T, HME202X, KME102X, KME201S, KME201X, KME202S, KME202X, KMEA20S, KMEA20X, LBES102, LBES201, LBES202, LBET102, LBET201, LBET202, ME102D, ME102H, ME102M, ME102P, ME102T, ME201D, ME201H, ME201M, ME201P, ME201T...(Other models you can see in the webshop)



<b>GEV No.</b>	418198	<b>Ref. No.</b>	65020110 65020120 LAR65020110 LAR65020120
----------------	--------	-----------------	--

**description** heating element 3150W 220V heating circuits 3 mounting ø 57.5mm L 240mm W 54mm H 54mm flange with thread immersion heater tube ø 6.3mm thermostat sleeves ø 6mm number of thermostat sleeves 1 length thermostat sleeves 220mm thermostat sleeve clinging

**For models:** ME004L, ME004S

**accessories for** 418198

	<b>GEV No.</b>	550002	<b>Ref. No.</b>	—
--	----------------	--------	-----------------	---

tension strap H 10mm L 21mm W 10mm hole ø 6.5mm for heating element



<b>GEV No.</b>	418199	<b>Ref. No.</b>	65020180 65020190 LAR65020180 LAR65020190
----------------	--------	-----------------	--

**description** heating element 3900W 230V heating circuits 3 mounting ø 57.5mm L 230mm W 35mm H 49mm round flange connection male faston 6.3mm immersion heater tube ø 8.5mm thermostat sleeves ø 7mm number of thermostat sleeves 1 length thermostat sleeves 210mm thermostat sleeve clinging

**For models:** ME104L, ME104S

**accessories for** 418199



	<b>GEV No.</b>	510409	<b>Ref. No.</b>	70045010 LA70045010 LAR70045010 R70045010
--	----------------	--------	-----------------	--



O-ring EPDM thickness 5.34mm ID ø 56.52mm Qty 1 pcs



	<b>GEV No.</b>	550002	<b>Ref. No.</b>	—
--	----------------	--------	-----------------	---

tension strap H 10mm L 21mm W 10mm hole ø 6.5mm for heating element





			
1			
<b>GEV No.</b>	418200	<b>Ref. No.</b>	65020240 65020270 65020280 65025100 LA65020280 LAR65020240 LAR65020270 LAR65020280 LAR65025100
<b>description</b>	heating element 6000W 230V heating circuits 3 mounting ø 57.5mm L 377mm W 50mm H 38mm round flange connection M4 immersion heater tube ø 8.5mm thermostat sleeves ø 7.5mm number of thermostat sleeves 1 length thermostat sleeves 260mm thermostat sleeve eccentric, clinging		
<b>For models:</b>	CBEN061, CBES061, CME061S, CME061X, KME061S, KME061X, ME105L, ME105S		
<b>spare parts for</b>	418200		
	<b>GEV No.</b>	510409	<b>Ref. No.</b> 70045010 LA70045010 LAR70045010 R70045010
O-ring EPDM thickness 5.34mm ID ø 56.52mm Qty 1 pcs			
<b>accessories for</b>	418200		
	<b>GEV No.</b>	550002	<b>Ref. No.</b> —
tension strap H 10mm L 21mm W 10mm hole ø 6.5mm for heating element			

			
1			
<b>GEV No.</b>	415848	<b>Ref. No.</b>	50303890 65020320 65020330 65020350 LA65020350 LAR50303890 LAR65020320 LAR65020330 LAR65020350
<b>description</b>	heating element 7500W 230V heating circuits 3 mounting ø 57.5mm L 365mm W 36mm H 50mm round flange connection M4 immersion heater tube ø 8.5mm thermostat sleeves ø 7.5mm number of thermostat sleeves 1 length thermostat sleeves 270mm thermostat sleeve eccentric, clinging		
<b>For models:</b>	AME07D, AME07P, AME10D, EM006H, EM006M+SC, EM010H, EM010M+SC, EM020M, EM106H, EM106M, EM106M+SC, EM106P, EM110H, EM110M, EM110M+SC, EM110P, EM210H, EM210M, EM210M+SC, EM210P, EMT06D, EMT10D, GEMT06P, GEMT06T, GEMT07S, GEMT07X, GEMT10P, GEMT10S, GEMT10T, GEMT10X, HME061P, HME061T, HME061X, HME101P, HME101S, HME101T, HME101X, KME072S, KME072X, KME081S, KME081X, KME101S, KME101X, LBES071, LBES072, LBES101, LBET071, LBET072, LBET101, ME061D...(Other models you can see in the webshop)		
<b>spare parts for</b>	415848		
	<b>GEV No.</b>	510409	<b>Ref. No.</b> 70045010 LA70045010 LAR70045010 R70045010
O-ring EPDM thickness 5.34mm ID ø 56.52mm Qty 1 pcs			
<b>accessories for</b>	415848		
	<b>GEV No.</b>	550002	<b>Ref. No.</b> —
tension strap H 10mm L 21mm W 10mm hole ø 6.5mm for heating element			

with round flange (miscellaneous)			
			
1			
<b>GEV No.</b>	417720	<b>Ref. No.</b>	65020340 LA65020340 LAR65020340
<b>description</b>	heating element 7500W 277V L 370mm W 40mm H 35mm heating circuits 3 flange ø 72mm round flange connection M4 for boiler tube ø 8.5mm thermostat sleeves ø 8.5mm number of thermostat sleeves 1 length thermostat sleeves 272mm thermostat sleeve clinging		
<b>For models:</b>	GEMT07S, GEMT07X, GEMT10S, GEMT10X, KME072S, KME072X, KME081S, KME081X, KME101S, KME101X, LBES071, LBES072, LBES101, LBET071, LBET072, LBET101, ME110X, ME120P, ME227M, ME227P, ME227X, NAE071, NAE071R, NAE072R, NAE101, NAE101R, NAE071, NAE071R, NAE072, NAE072R, NAE101, NAE101R, SAE071, SAE071R, SAE072, SAE072R, SAE101		
<b>accessories for</b>	417720		
	<b>GEV No.</b>	510409	<b>Ref. No.</b> 70045010 LA70045010 LAR70045010 R70045010
O-ring EPDM thickness 5.34mm ID ø 56.52mm Qty 1 pcs			

### heating elements for convection

			
1			
<b>GEV No.</b>	418195	<b>Ref. No.</b>	65010870 65010890 65011610 LA65011610 LAR65010870 LAR65010890 LAR65011610
<b>description</b>	heating element 12000W 230V heating circuits 3 L 520mm W 255mm H 135mm H1 100mm H2 30mm flange length 100mm flange width 72mm hole distance 85mm connection M4 connection length 40mm tube ø 8.5mm convection heating element hole ø 6.5mm rectangular flange		
<b>For models:</b>	ME210L, ME210S, ME210T, ME220L, ME220S, ME220T, MG210L, MG210S, VE210L, VE210S, VE210T		

			
1			
<b>GEV No.</b>	418194	<b>Ref. No.</b>	65010880 65010900 65011620 LA65011620 LAR65010880 LAR65010900 LAR65011620
<b>description</b>	heating element 12000W 230V heating circuits 3 L 540mm W 260mm H 135mm H1 100mm H2 35mm flange length 100mm flange width 82mm hole distance 85mm connection M4 tube ø 8.5mm convection heating element hole ø 6mm rectangular flange		
<b>For models:</b>	ME210L, ME210S, ME210T, ME220L, ME220S, ME220T, MG210L, MG210S, VE210L, VE210S, VE210T		



<b>GEV No.</b>	415828	<b>Ref. No.</b>	65011310 LAR65011310
<b>description</b>	heating element 15000W 230V heating circuits 3 ID ø 388mm ED ø 408mm L 428mm H 132mm L1 20mm W1 105mm H1 114mm H2 18mm flange length 140mm flange width 25mm hole distance 126mm connection M4 connection length 65mm tube ø 8.5mm convection heating element hole ø 6.3mm rectangular flange		
<b>For models:</b>	ABE084S, ABE104S, ABE156X, ACE10M, AME10D, AREN084, AREN154, ARES084, ARES154, AVE10D, AVE10P, BPE084M, BPE084P, BPE104M, BPE104P, CE100M, CE110M, CE210M, CEC40M, CES24M, CES40M, CKES10, EC020M, EC110M, EC210M, EM010H, EM010M+SC, EM020M, EM110H, EM110M, EM110M+SC, EM110P, EM210H, EM210M, EM210M+SC, EM210P, EMT10D, EMT20P, EMT21P, EPE086T, EPE156T, EPEV08T, EPEV15T, EV010H, EV010M, EV010P, EV020M, EV110H, EV110M, EV110M+SC...(Other models you can see in the webshop)		



<b>GEV No.</b>	418197	<b>Ref. No.</b>	65011250 LA65011250 LAR65011250
<b>description</b>	heating element 15000W 230V heating circuits 3 ID ø 512mm ED ø 530mm L 545mm H 130mm L1 15mm W1 105mm H1 25mm H2 105mm flange length 142mm flange width 25mm hole distance 126mm connection M4 connection length 68mm tube ø 8.5mm convection heating element hole ø 6mm rectangular flange		
<b>For models:</b>	CE210M, CEC40M, CES24M, CES40M, EC020M, EC210M, EM020M, EM210H, EM210M, EM210M+SC, EM210P, EMT20P, EV020M, EV210H, EV210M, EV210M+SC, EV210P, EVEA20S, EVT20D, FEI102P, GEMT20P, GEMT20S, GEMT20T, GEMT20X, GEMT40P, GEMT40S, GEMT40T, GEMT40X, GEVT20P, GEVT20S, GEVT20T, GEVT20X, GEVT40P, GEVT40S, GEVT40T, GEVT40X, HME102P, HME102S, HME102T, HME102X, HME202P, HME202S, HME202T, HME202X, HVE102P, HVE102S, HVE102T, HVE102X, HVE202P, HVE202T...(Other models you can see in the webshop)		

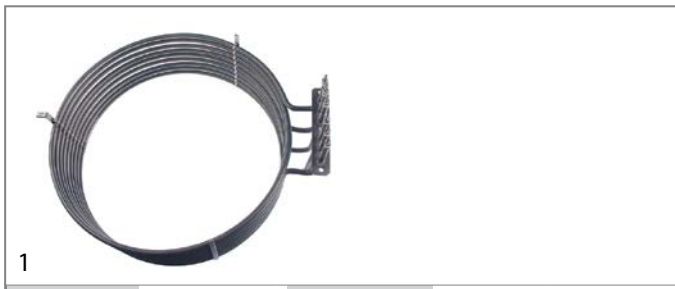

<b>GEV No.</b>	418088	<b>Ref. No.</b>	6002121
<b>description</b>	heating element 25000W 400V heating circuits 3 ID ø 388mm ED ø 406mm L 452mm H 150mm L1 35mm W1 105mm H1 21mm H2 130mm flange length 142mm flange width 25mm hole distance 126mm connection M4 connection length 72mm tube ø 8.5mm convection heating element hole ø 6mm rectangular flange		
<b>For models:</b>	VE102MX		
<b>accessories for</b>	418088		
	<b>GEV No.</b>	550548	<b>Ref. No.</b> 2005173
	gasket L 144mm W 25.5mm thickness 2.2mm for heating element suitable for GIORIK equip. no. 2005173		

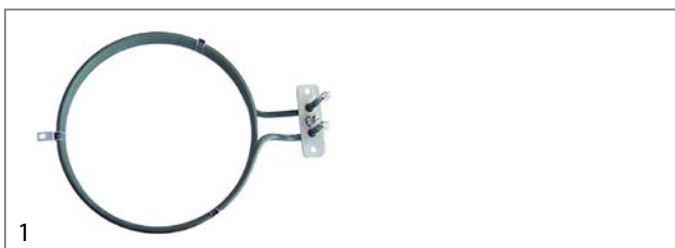



<b>GEV No.</b>	415251	<b>Ref. No.</b>	65010200 LA65010200 LAR65010200
<b>description</b>	heating element 2500W 230V heating circuits 1 ID ø 178mm ED ø 190mm L 242mm H 35mm L1 46mm W1 31mm H1 10mm H2 25mm flange length 70mm flange width 22mm hole distance 56mm connection male faston 6.3mm horizontal tube ø 6.3mm convection heating element hole ø 5mm rectangular flange		
<b>For models:</b>	AC04, AC05, AC08, AC10, AC20, AU04, AU05, AU08, AU10, AU20, LA10, LA15, LA16, LA18, LV10, LV15, LV16, LV18, REC023M		
<b>spare parts for</b>	415251		
	<b>GEV No.</b>	510368	<b>Ref. No.</b> —
	gasket L 70mm W 23.5mm hole ø 5mm hole distance 56mm FIBER thickness 2mm for heating element		







			
1			
<b>GEV No.</b>	415845	<b>Ref. No.</b>	65010280 65010300 65010320 A34300510 LA65010321 LAR65010280 LAR65010300 LAR65010320
<b>description</b>	heating element 3150W 230V heating circuits 3 ID ø 201mm ED ø 215mm L 272mm H 35mm L1 57mm W1 60mm H1 8mm H2 27mm flange length 95mm flange width 22mm hole distance 77mm connection male faston 6.3mm connection length 20mm tube ø 6.5mm convection heating element hole ø 6mm rectangular flange		
<b>For models:</b>	ACE04M, CE041M, CVE004H, CVE004M, MACE04M, MCE042M, ME004L, ME004S, MVE042P, SVE042S, VE004D, VE004H, VE004M, VE004S, VE004X, VE042P		

			
1			
<b>GEV No.</b>	418191	<b>Ref. No.</b>	50303560 65011500 65015830 LA65011500 LAR50303560 LAR65011500 LAR65015830
<b>description</b>	heating element 5400W 230V heating circuits 3 ID ø 194mm ED ø 205mm L 270mm H 85mm L1 65mm W1 103mm H1 20mm H2 65mm flange length 140mm flange width 22mm hole distance 62mm connection M4 connection length 65mm tube ø 6.5mm convection heating element hole ø 5mm rectangular flange		
<b>For models:</b>	FE05		

			
2			
<b>GEV No.</b>	417721	<b>Ref. No.</b>	65010330 LA65010330 R65010330
<b>description</b>	heating element 3150W 230V heating circuits 3 ID ø 204mm ED ø 216mm L 282mm H 42mm W1 83mm H2 29mm flange length 93mm flange width 22mm hole distance 77mm cable length 6.3mm hole ø 6mm		

			
1			
<b>GEV No.</b>	418196	<b>Ref. No.</b>	65011530 LA65011530 LAR65011530
<b>description</b>	heating element 6000W 230V heating circuits 3 ID ø 215mm ED ø 228mm L 266mm H 78mm L1 38mm W1 102mm H1 10mm H2 68mm flange length 142mm flange width 25mm hole distance 57mm connection M4 connection length 66mm tube ø 6.3mm convection heating element hole ø 6mm rectangular flange		
<b>For models:</b>	A05PES, A05PES+UM, A05RES, A05RES+UM, A08PES, A08PES+UM, A08RES, A08RES+UM, A10PES, A10PES+UM, A10RES, A10RES+UM, ABE044M, ABE054M, ACE05M, BPE044M, BPE044P, BPE054M, BPE054P, CE051M, MACE05M, MCE051M, MVE051P, PE044M, PE054M, REC051M, REC071M, REP054M, REV051M, REV071M, REV071S, REV101M, SCE051M, SVE051S, VE051P, VE055P		

			
1			
<b>GEV No.</b>	415855	<b>Ref. No.</b>	65010430 65010431 65010440 65010441 65010450 LA65010450 LAR65010430 LAR65010431 LAR65010440 LAR65010441 LAR65010450
<b>description</b>	heating element 3900W 230V heating circuits 3 ID ø 176mm ED ø 244mm L 282mm H 43mm L1 38mm W1 61mm H1 13mm H2 30mm flange length 92mm flange width 22mm hole distance 78mm connection male faston 6.3mm connection length 60mm tube ø 6.3mm convection heating element hole ø 6.3mm rectangular flange		
<b>For models:</b>	CVE104H, CVE104M, ME104L, ME104S, VE104D, VE104H, VE104M, VE104S, VE104X		



<b>GEV No.</b>	415871	<b>Ref. No.</b>	50303270 50303280 50303820 65010510 65010530 65011520 65015910 65015920 LA65011520 LAR50303270 LAR50303280 LAR50303820 LAR65010510 LAR65010530 LAR65011520 LAR65015910 LAR65015920
<b>description</b>	heating element 6000W 230V heating circuits 3 ID ø 217mm ED ø 230mm L 267mm H 75mm L1 38mm W1 103mm H1 65mm H2 10mm flange length 140mm flange width 23mm hole distance 67mm connection M4 connection length 25mm tube ø 6.5mm convection heating element hole ø 5mm rectangular flange		
<b>For models:</b>	CVE105H, CVE105M, ME05, ME105L, ME105S, MME05, MVE042P, RE05, VE042P, VE105D, VE105H, VE105M, VE105NS, VE105S, VE105X, VE155H, VE155M, VE155X		



<b>GEV No.</b>	420525	<b>Ref. No.</b>	65011730 LA65011730 LAR65011730
<b>description</b>	heating element 7000W 230V heating circuits 3 ID ø 248mm ED ø 260mm L 298mm H 87mm L1 10mm W1 102mm H1 15mm H2 66mm flange length 142mm flange width 25mm hole distance 127mm connection M4 tube ø 6.5mm		
<b>For models:</b>	REC051M, REP044S, REP054S, REV051S, REV101S		





<b>GEV No.</b>	415993	<b>Ref. No.</b>	50303580 50303830 65010680 65016010 65016020 LA65010680 LAR50303580 LAR50303830 LAR65010680 LAR65016010 LAR65016020
<b>description</b>	heating element 7200W 230V heating circuits 3 ID ø 215mm ED ø 230mm L 270mm H 78mm L1 30mm W1 102mm H1 10mm H2 68mm flange length 140mm flange width 22mm hole distance 63mm connection M4 connection length 65mm tube ø 6.3mm convection heating element hole ø 5mm rectangular flange		
<b>For models:</b>	FE051M, FE051X, FE105M, FE105X, PE040M, PE040X, PE041M, PE041X, PE051M, PE051X		





<b>GEV No.</b>	415829	<b>Ref. No.</b>	56010570 65010570 65010580 65011540 A34300700 LA65011541 LAR65010570 LAR65010580 LAR65011540
<b>description</b>	heating element 7500W 230V heating circuits 3 ID ø 248mm ED ø 260mm L 287mm H 88mm L1 20mm W1 105mm H1 23mm H2 65mm flange length 142mm flange width 25mm hole distance 64mm connection M4 connection length 78mm convection heating element hole ø 5mm rectangular flange		
<b>For models:</b>	AME07D, AME07P, APE06, APE07, AVE07D, AVE07P, BPE064M, BPE064P, BPE074M, BPE074P, CE071M, CE106M, EC106M, EM006H, EM006M+SC, EM106H, EM106M, EM106M+SC, EM106P, EMT06D, EPE056T, EV006M, EV006P, EV106H, EV106M, EV106M+SC, EV106P, EVT06D, EVT06P, FME61A, FME61S, GEMT06P, GEMT06T, GEVT06P, GEVT06S, GEVT06T, HME061P, HME061T, HME061X, HVE061P, HVE061T, HVE061X, MACE07M, MCE071M, ME061D, ME061H, ME061M, ME061P, ME061T, ME106D...(Other models you can see in the webshop)		
<b>accessories for</b>	415829		
	<b>GEV No.</b>	531270	<b>Ref. No.</b> —
	gasket L 141mm W 22mm D1 ø 10mm D2 ø 9mm 9 holes graphite thickness 1mm suitable for UNOX		





			
<b>GEV No.</b>	418192	<b>Ref. No.</b>	65010620 65010640 65011590 LA65011590 LAR65010620 LAR65010640 LAR65011590
<b>description</b>	heating element 7500W 230V heating circuits 3 L 525mm W 250mm H 130mm H1 20mm H2 110mm flange length 100mm flange width 80mm hole distance 94mm connection M4 tube ø 6.3mm convection heating element hole ø 6.5mm rectangular flange		
<b>For models:</b>	ME110L, ME110S, ME110T, ME120L, ME120S, ME120T, PE008D, PE008K, PE008M, PE015D, PE015K, PE015M, PE108D, PE108K, PE108M, PE108T, PE115D, PE115K, PE115M, PE115T, VE110L, VE110S, VE110T, VE120L, VE120S		

			
<b>GEV No.</b>	415827	<b>Ref. No.</b>	65011210 LAR65011210
<b>description</b>	heating element 9000W 230V heating circuits 3 ID ø 508mm ED ø 526mm L 550mm H 122mm L1 24mm W1 105mm H1 26mm H2 96mm flange length 140mm flange width 25mm hole distance 126mm connection M4 connection length 68mm tube ø 9mm convection heating element hole ø 6.3mm rectangular flange		
<b>For models:</b>	ME210D, ME210H, ME210M, ME210P, ME210X, ME220D, ME220H, ME220M, ME220P, ME220X, VE210D, VE210H, VE210M, VE210P, VE210X, VE220D, VE220H, VE220M, VE220P, VE220X		

			
<b>GEV No.</b>	418193	<b>Ref. No.</b>	65010610 65010630 65011580 LAR65010610 LAR65010630 LAR65011580
<b>description</b>	heating element 7500W 230V heating circuits 3 L 560mm W 255mm H 135mm H1 17mm H2 118mm flange length 100mm flange width 80mm hole distance 85mm connection M4 connection length 70mm tube ø 6.3mm convection heating element hole ø 6mm rectangular flange		
<b>For models:</b>	ME110L, ME110S, ME110T, ME120L, ME120S, ME120T, PE008D, PE008K, PE008M, PE015D, PE015K, PE015M, PE108D, PE108K, PE108M, PE108T, PE115D, PE115K, PE115M, PE115T, VE110L, VE110S, VE110T, VE120L, VE120S		

			
<b>GEV No.</b>	415387	<b>Ref. No.</b>	50303160 65010110 65015210 LAR50303160 LAR65010110 LAR65015210
<b>description</b>	heating element 1800W 230V heating circuits 1 L 534mm W 120mm L1 30mm L2 504mm W2 90mm flange length 70mm flange width 22mm hole distance 56mm connection M4 tube ø 6.3mm hole ø 5mm W1 30mm rectangular flange convection heating element windings 2		
<b>For models:</b>	ME15, PE12		

			
<b>GEV No.</b>	419110	<b>Ref. No.</b>	65011900 LA65011900 LAR65011900
<b>description</b>	heating element 9000W 230V heating circuits 3 ID ø 250mm ED ø 266mm L 290mm H 93mm L1 24mm W1 105mm H1 11mm H2 82mm flange length 142mm flange width 25mm hole distance 63mm connection M4 tube ø 8.5mm hole ø 6.1mm		
<b>For models:</b>	MVE071M, SCE071M, SME071S, SVE071P, SVE071S		

			
<b>GEV No.</b>	415737	<b>Ref. No.</b>	50303150 50303860 65010130 65010140 65010141 65010180 65015300 65015310 LA65010180 LAR50303150 LAR50303860 LAR65010130 LAR65010140 LAR65010141 LAR65010180 LAR65015300 LAR65015310
<b>description</b>	heating element 2500W 230V heating circuits 1 L 655mm W 120mm L1 30mm L2 625mm W2 90mm flange length 70mm flange width 22mm hole distance 56mm connection length 100mm connection M4 tube ø 6.3mm hole ø 5.5mm W1 30mm rectangular flange convection heating element windings 2		
<b>For models:</b>	FE101M, FE101X, FE110M, FE110X, ME10, ME21, MME10, PE08, PE080M, PE080X, PE081M, PE081X, PE101M, PE101X, RE10		



1 			
<b>GEV No.</b>	415736	<b>Ref. No.</b>	50303170 65010371 65010390 65015660 65015670 LAR50303170 LAR65010371 LAR65010390 LAR65015660 LAR65015670
<b>description</b>	heating element 3500W 230V heating circuits 1 L 655mm W 125mm L1 30mm L2 625mm W2 88mm flange length 70mm flange width 22mm hole distance 56mm connection length 97mm connection M4 tube ø 6.25mm hole ø 5mm W1 30mm rectangular flange convection heating element windings 2 mounting distance 58mm		
<b>For models:</b>	FE102M, FE102X, FE210M, FE210X, ME20, ME24, ME40, MG20, MME40, RE20, RE24		

## accessories

## sealing washers

## fibre gaskets

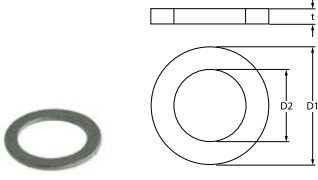
1 			
<b>GEV No.</b>	510404	<b>Ref. No.</b>	682770
<b>description</b>	flat gasket fibre ED ø 44mm ID ø 34mm thickness 2mm Qty 1 pcs		

## flange gaskets

1 			
<b>GEV No.</b>	550548	<b>Ref. No.</b>	2005173
<b>description</b>	gasket L 144mm W 25.5mm thickness 2.2mm for heating element suitable for GIORIK equiv. no. 2005173		
<b>For models:</b>	VE102MX		

## energy regulators

## EGO

## 1-circuit

1 			
<b>GEV No.</b>	380015	<b>Ref. No.</b>	50304011 6031023 65080250 A34100700 LA65080250 LAR50304011 LAR65080250
<b>description</b>	energy regulator 230V 13A single-circuit turn direction right shaft ø 6x4.6mm shaft L 23mm mounting thread M4 power release 6-100% no. 50.57021.010		
<b>For models:</b>	CE106M, CE110M, CE210M, CEC40M, CES24M, CES40M, CG106M, CG110M, CG210M, CGC40M, CGS24M, CGS40M, FE05, FG05, PE08, PE12, PG04, PG08, PG12, RC162M, RE05, RE07, RE10, RE20, RE24, REC023M, REC051M, REC071M, REC101M, REP044M, REP054M, REP064M, REP074M, RG05, RG07, RG10, RG20, RG24, RG40, RGC051M, RGC071M, RGC101M, RGP044M, RGP054M, RGP064M, RGP074M, RGP084M, RGP104M, SCE051M, SCE071M...(Other models you can see in the webshop)		

## thermostats

## control and safety thermostats

## EGO

## control thermostats

## 55.10/19\_ series

1 			
<b>GEV No.</b>	390068	<b>Ref. No.</b>	50304031 LAR50304031
<b>description</b>	thermostat t.max. 269°C temperature range 55-269°C 1-pole 1CO 16A probe ø 3.1mm probe L 219mm capillary pipe 1280mm capillary pipe isolated 1270mm gland nut shaft ø 6x4.6mm shaft L 23mm shaft position upper° rotation 318°		
<b>For models:</b>	FE04, FE05, FG05, MME05, MME10, MME40, PE08, PE12, PG04, PG08, PG12, RE05, RE07, RE10, RE20, RE24, RG05, RG07, RG10, RG20, RG24, RG40		



<b>GEV No.</b>	375216	<b>Ref. No.</b>	50304030 65070210 65070250 LA65070210 LAR65070210 LAR65070250
<b>description</b>	thermostat t.max. 280°C temperature range 50-280°C 1-pole 1NO 16A probe ø 3mm probe L 228mm capillary pipe 1300mm capillary pipe isolated 1150mm gland nut shaft L 23mm shaft position upper rotation 318°		
<b>For models:</b>	CE106M, CE110M, CE210M, CEC40M, CES24M, CES40M, CG105M, CG106M, CG110M, CG210M, CGC24M, CGC40M, CGS24M, CGS40M, CVE004M, CVE104M, CVE105M, CVG105M, ECO20M, EC106M, EC110M, EC210M, EM006M+SC, EM010M+SC, EM020M, EM106M, EM106M+SC, EM110M, EM110M+SC, EM210M, EM210M+SC, EV006M, EV010M, EV020M, EV106M, EV106M+SC, EV110M, EV110M+SC, EV210M, EV210M+SC, FE051M, FE051X, FE101M, FE101X, FE102M, FE102X, FE105M, FE105X, FE110M, FE110X...(Other models you can see in the webshop)		



<b>GEV No.</b>	375002	<b>Ref. No.</b>	1037102300
<b>description</b>	thermostat t.max. 320°C temperature range 55-320°C 1-pole 1NO 16A probe ø 3.1mm probe L 226mm capillary pipe 870mm capillary pipe isolated 850mm gland nut shaft L 23mm shaft position upper rotation 270°		



<b>GEV No.</b>	375667	<b>Ref. No.</b>	65070360 LA65070360 LAR65070360
<b>description</b>	thermostat t.max. 300°C temperature range 68-300°C 1-pole 1NO 16A probe ø 3.1mm probe L 226mm capillary pipe 980mm capillary pipe isolated 980mm gland nut shaft ø 6x4.6mm shaft L 23mm shaft position upper rotation 318°		
<b>For models:</b>	ABE044M, ABE054M, ABG064M, ABG074M, ACE04M, ACE05M, ACE10M, ACG10M, APE06, APE07, APG08M, APG10M, BPE044M, BPE054M, BPE064M, BPE074M, BPE084M, BPE104M, BPG044M, BPG054M, BPG064M, BPG074M, BPG084M, BPG104M, CE041M, CE051M, CE071M, CE100M, CE200M, CG051M, CG071M, CG100M, CG200M, MACE04M, MACE05M, MACE07M, MACE10M, MACE20M, MACG05M, MACG07M, MACG10M, MACG20M, MCE042M, MCE051M, MCE071M, MCE101M, MCE102M, MCE201M, MCE202M, MCG051M...(Other models you can see in the webshop)		



<b>GEV No.</b>	375219	<b>Ref. No.</b>	65070100 LAR65070100	
<b>description</b>	thermostat t.max. 55°C temperature range fixed 55°C 1-pole 1NO 16A probe ø 6mm probe L 130mm capillary pipe 900mm capillary pipe isolated 850mm gland nut shaft Lmm shaft position probe material SS			
<b>For models:</b>	EM006M+SC, EM010M+SC, EM020M, EM106M, EM106M+SC, EM110M, EM110M+SC, EM210M, EM210M+SC, GM020M, GM106M, GM106M+SC, GM110M, GM110M+SC, GM210M, GM210M+SC, ME061M, ME101M, ME102D, ME102M, ME106M, ME106X, ME110M, ME110X, ME120M, ME120X, ME201M, ME202M, ME210M, ME210X, ME220M, ME220X, MEC20X, MEC40M, MES20M, MES20X, MES24M, MES24X, MES40M, MES40X, MG061M, MG101M, MG102M, MG106M, MG106X, MG110M, MG110X, MG120M, MG120X, MG201M...(Other models you can see in the webshop)			
<b>accessories for</b>	375219			
	<b>GEV No.</b>	550148	<b>Ref. No.</b>	—
	gland duct ET M12x0.75 IT M9x1 probe ø max. 6.5mm WS 17 silicone			





<b>GEV No.</b>	375215	<b>Ref. No.</b>	65070165 LAR65070165 LAR65070165
<b>description</b>	thermostat t.max. 65°C temperature range fixed 65°C 1-pole 1CO 16A probe ø 6mm probe L 130mm capillary pipe 900mm capillary pipe isolated 900mm gland nut shaft Lmm shaft position		
<b>For models:</b>	BPE064M, BPE074M, BPE084M, BPE104M, BPG064M, BPG074M, BPG084M, BPG104M, CG105M, CVE004M, CVE104M, CVE105M, CVG105M, EM006M+SC, EM010M+SC, EM020M, EM106M, EM106M+SC, EM110M, EM110M+SC, EM210M, EM210M+SC, EV006M, EV010M, EV020M, EV106M, EV106M+SC, EV110M, EV110M+SC, EV210M, EV210M+SC, FME61A, FME61S, FMG201A, FMG201S, GM020M, GM106M, GM106M+SC, GM110M, GM110M+SC, GM210M, GM210M+SC, GV006M, GV010M, GV106M, GV106M+SC, GV110M, GV110M+SC, GV210M, GV210M+SC...(Other models you can see in the webshop)		



<b>GEV No.</b>	375217	<b>Ref. No.</b>	65070240 65074990 LAR65070240 LAR65074990
<b>description</b>	thermostat t.max. 70°C temperature range fixed 70°C 1-pole 1CO 16A probe ø 6mm probe L 130mm capillary pipe 900mm capillary pipe isolated 900mm gland nut shaft Lmm shaft position probe material SS		
<b>For models:</b>	BPE064M, BPE074M, BPE084M, BPE104M, BPG064M, BPG074M, BPG084M, BPG104M, CG105M, CVE004M, CVE104M, CVE105M, CVG105M, EM006M+SC, EM010M+SC, EM020M, EM106M, EM106M+SC, EM110M, EM110M+SC, EM210M, EM210M+SC, EV006M, EV010M, EV020M, EV106M, EV106M+SC, EV110M, EV110M+SC, EV210M, EV210M+SC, FME61A, FME61S, FMG201A, FMG201S, GM020M, GM106M, GM106M+SC, GM110M, GM110M+SC, GM210M, GM210M+SC, GV006M, GV010M, GV106M, GV106M+SC, GV110M, GV110M+SC, GV210M, GV210M+SC...(Other models you can see in the webshop)		



<b>GEV No.</b>	390807	<b>Ref. No.</b>	65070140 LAR65070140
<b>description</b>	thermostat temperature range 30-110°C 1-pole probe ø 6mm probe L 139mm capillary pipe 3000mm capillary pipe isolated 2950mm gland nut shaft ø 6x4.6mm shaft L 24mm rotation 270°		

55.34\_ series



<b>GEV No.</b>	390073	<b>Ref. No.</b>	50304050 50304052 65075070 LAR50304050 LAR50304052 LAR65075070
<b>description</b>	thermostat t.max. 145°C temperature range 85°C/145°C 2-pole 2NC 16A probe ø 6mm probe L 130mm capillary pipe 900mm capillary pipe isolated 900mm gland nut probe material SS		
<b>For models:</b>	FV03, FV06, ME05, ME10, ME15, ME20, ME21, ME24, ME40, MG05, MG10, MG15, MG20, MG21, MG24, MG40, MME05, MME10, MME40		



<b>GEV No.</b>	375192	<b>Ref. No.</b>	1309115
<b>description</b>	thermostat t.max. 300°C temperature range 50-300°C 3-pole 3NO 16A probe ø 3mm probe L 219mm capillary pipe 900mm capillary pipe isolatedmm gland nut shaft ø 6x4.6mm shaft L 23mm shaft position upper rotation 270°		



safety thermostats

55.10/19\_ series

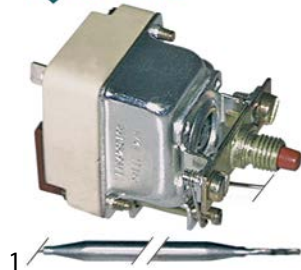

<b>GEV No.</b>	375218	<b>Ref. No.</b>	50304097 65075020 LAR65075020
<b>description</b>	safety thermostat switch-off temp. 145°C 1-pole 16A probe ø 6mm probe L 130mm capillary pipe 900mm capillary pipe isolated 900mm gland nut probe SS		
<b>For models:</b>	ME004L, ME004S, ME104L, ME104S, ME105L, ME105S, ME106L, ME106S, ME110L, ME110S, ME120L, ME120S, ME210L, ME210S, ME220L, ME220S, MG105L, MG105S, MG106L, MG106S, MG110L, MG110S, MG120L, MG120S, MG210L, MG210S, MG220L, MG220S		

55.32\_ series

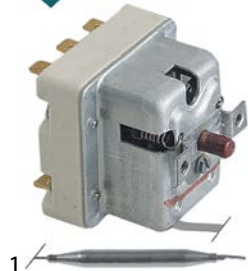

<b>GEV No.</b>	375668	<b>Ref. No.</b>	65070020 65075030 LAR65070020 LAR65075030
<b>description</b>	safety thermostat switch-off temp. 140°C 3-pole 20A probe ø 6mm probe L 88mm capillary pipe 890mm capillary pipe isolated 800mm gland nut		
<b>For models:</b>	AC04, AC05, AC08, AC10, AC20, AU04, AU05, AU08, AU10, AU20, ME004L, ME004S, ME104L, ME104S		

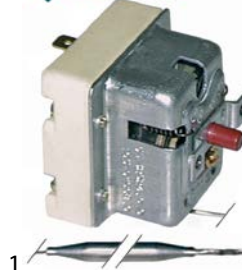

<b>GEV No.</b>	390159	<b>Ref. No.</b>	65070080 65070081 65075000 LAR65070080 LAR65070081 LAR65075000
<b>description</b>	safety thermostat switch-off temp. 150°C 1-pole 20A probe ø 6mm probe L 89mm capillary pipe 900mm capillary pipe isolated 800mm gland nut probe		
<b>For models:</b>	AME07D, AME07P, AME10D, CBEN061, CBES061, CME061S, CME061X, EM006H, EM006M+SC, EM010H, EM010M+SC, EM020M, EM106H, EM106M, EM106M+SC, EM106P, EM110H, EM110M, EM110M+SC, EM110P, EM210H, EM210M, EM210M+SC, EM210P, EMT06D, EMT10D, EMT20P, EMT21P, GEMT06P, GEMT06T, GEMT07S, GEMT07X, GEMT10P, GEMT10S, GEMT10T, GEMT10X, GEMT20P, GEMT20S, GEMT20T, GEMT20X, GEMT21P, GEMT21S, GEMT21T, GEMT21X, GEMT40P, GEMT40S, GEMT40T, GEMT40X, GGMT06P, GGMT06T...(Other models you can see in the webshop)		



<b>GEV No.</b>	375649	<b>Ref. No.</b>	A34102070
<b>description</b>	safety thermostat switch-off temp. 160°C 3-pole 20A probe ø 6mm probe L 87mm capillary pipe 890mm capillary pipe isolated 880mm gland nut probe SS		



<b>GEV No.</b>	375220	<b>Ref. No.</b>	65070050 LAR65070050
<b>description</b>	safety thermostat switch-off temp. 330°C 3-pole 20A probe ø 11mm probe L 18.5mm capillary pipe 900mm capillary pipe isolated 900mm gland nut probe screw-in probe probe thread M14x1		
<b>For models:</b>	CVE004H, CVE004M, CVE104H, CVE104M, ME004L, ME004S, ME104L, ME104S, VE004D, VE004H, VE004M, VE004S, VE004X, VE104D, VE104H, VE104M, VE104S, VE104X		



<b>GEV No.</b>	375291	<b>Ref. No.</b>	50304092 65070040 65070060 65075040 A34100780 LA65070060 LAR50304092 LAR65070060 LAR65075040
<b>description</b>	safety thermostat switch-off temp. 344°C 1-pole 20A probe ø 6mm probe L 79mm capillary pipe 900mm capillary pipe isolated 900mm gland nut probe		
<b>For models:</b>	FE04, FE051M, FE051X, FE101M, FE101X, FE102M, FE102X, FE105M, FE105X, FE110M, FE110X, FE210M, FE210X, FG051M, FG051X, FG101M, FG101X, FG102M, FG102X, FG105M, FG105X, FG110M, FG110X, FG210M, FG210X, ME05, ME10, ME15, ME20, ME21, ME24, ME40, MG05, MG10, MG15, MG20, MG21, MG24, MG40, MME05, MME10, MME40, PE04, PE040M, PE040X, PE041M, PE041X, PE051M, PE051X, PE08...(Other models you can see in the webshop)		



<b>GEV No.</b>	375455	<b>Ref. No.</b>	65070070 LA65070070 LAR65070070
<b>description</b>	safety thermostat switch-off temp. 350°C 1-pole 16A probe ø 11mm probe L 16mm capillary pipe 900mm capillary pipe isolated 900mm gland nut probe screw-in probe probe thread M14x1		
<b>For models:</b>	CE106M, CE110M, CE210M, CEC40M, CES24M, CES40M, CG105M, CG106M, CG110M, CG210M, CGC24M, CGC40M, CGS24M, CGS40M, CVE105H, CVE105M, CVG105H, CVG105M, ECO20M, EC106M, EC110M, EC210M, EM006H, EM006M+SC, EM010H, EM010M+SC, EM020M, EM106H, EM106M, EM106M+SC, EM106P, EM110H, EM110M, EM110M+SC, EM110P, EM210H, EM210M, EM210M+SC, EM210P, EV006M, EV006P, EV010H, EV010M, EV010P, EV020M, EV106H, EV106M, EV106M+SC, EV106P, EV110H...(Other models you can see in the webshop)		

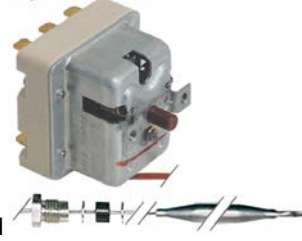

<b>GEV No.</b>	375628	<b>Ref. No.</b>	6010008
<b>description</b>	safety thermostat switch-off temp. 350°C 3-pole 20A probe ø 4mm probe L 120mm capillary pipe 900mm capillary pipe isolated 670mm gland nut M10x1 probe SS		
<b>For models:</b>	VE102MX		



<b>GEV No.</b>	375684	<b>Ref. No.</b>	65070350 LA65070350 LAR65070350
<b>description</b>	safety thermostat switch-off temp. 360°C 1-pole 20A probe ø 11mm probe L 16mm capillary pipe 900mm capillary pipe isolated 900mm gland nut probe screw-in probe probe thread M14x1		
<b>For models:</b>	ABE044M, ABE054M, ABE084S, ABE104S, ABE156X, ABG064M, ABG074M, ABG084X, ABG104X, ABG156S, ACE04M, ACE05M, ACE10M, ACG10M, AME07D, AME07P, AME10D, APE06, APE07, APG08M, APG10M, AREN064, AREN084, AREN154, ARES064, ARES084, ARES154, ARGN064, ARGN084, ARGN154, ARGS064, ARGS084, ARGS154, AVE07D, AVE07P, AVE10D, AVE10P, AVG05P, AVG10D, AVG20D, BPE044M, BPE044P, BPE054M, BPE054P, BPE064M, BPE064P, BPE074M, BPE074P, BPE084M, BPE084P...(Other models you can see in the webshop)		



<b>GEV No.</b>	390808	<b>Ref. No.</b>	65070340 LAR65070340
<b>description</b>	safety thermostat switch-off temp. 360°C 3-pole probe ø 4mm probe L 124mm capillary pipe 900mm capillary pipe isolated 900mm gland nut		
<b>For models:</b>	EPEV05T, EPEV08T, EPEV15T, EPGV05T, EPGV08T, EPGV15T, PEV08T		





CAEM			
safety thermostats			
			
<b>GEV No.</b>	391038	<b>Ref. No.</b>	65070410 65070460 LA65070460 LAR65070410 LAR65070460
<b>description</b>	thermostat switch-off temp. 360°C temperature range°C 1-pole 1NC 10A probe ø 3mm probe L 150mm capillary pipe 1050mm capillary pipe isolatedmm gland nut shaft ømm S5		
<b>For models:</b>	A05PES, A05PES+UM, A05RES, A05RES+UM, A08PES, A08PES+UM, A08RES, A08RES+UM, A10PES, A10PES+UM, A10RES, A10RES+UM, REC023M, REC051M, REC071M, REC101M, REP044M, REP044S, REP054M, REP054S, REP064M, REP064S, REP074M, REP074S, REP084M, REP084S, REP104M, REP104S, REV051M, REV051S, REV071M, REV071S, REV101M, REV101S, RGC051M, RGC071M, RGC101M, RGP044M, RGP044S, RGP054M, RGP054S, RGP064M, RGP064S, RGP074M, RGP074S, RGP084M, RGP084S, RGP104M, RGP104S, RGV051M...(Other models you can see in the webshop)		



accessories



connecting bows			
			
<b>GEV No.</b>	550060	<b>Ref. No.</b>	921200 MA921200
<b>description</b>	connecting bow long for thermostat Qty 1 pcs		

switches and momentary switches  
rocker/momentary rocker switches



30x22mm			
			
<b>GEV No.</b>	301003	<b>Ref. No.</b>	R65267010
<b>description</b>	rocker switch mounting measurements 30x22mm green 2NO 250V 16A illuminated 0-1 connection male faston 6.3mm ambient temperature max. 125/55°C protection IP65		
<b>accessories for</b>	301003		
	<b>GEV No.</b>	<b>Ref. No.</b>	301036
			9410001
	protective cover internal size 30x22mm for rocker switch mounting measurementsmm		



			
<b>GEV No.</b>	301036	<b>Ref. No.</b>	9410001
<b>description</b>	protective cover internal size 30x22mm for rocker switch mounting measurementsmm		

blank			
			
<b>GEV No.</b>	347706	<b>Ref. No.</b>	65260510 LAR65260510
<b>description</b>	momentary rocker switch mounting measurements 30x22mm black 2CO 250V 16A connection male faston 6.3mm ambient temperature max. 100/55°C protection IP65 with cover cap		
<b>For models:</b>	EC020M, EC106M, EC110M, EC210M, EM006M+SC, EM010M+SC, EM020M, EM106M, EM106M+SC, EM110M, EM110M+SC, EM210M, EM210M+SC, EV006M, EV010M, EV020M, EV106M, EV106M+SC, EV110M, EV110M+SC, EV210M, EV210M+SC, FE051M, FE051X, FE101M, FE101X, FE102M, FE102X, FE105M, FE105X, FE110M, FE110X, FE210M, FE210X, FG051M, FG051X, FG101M, FG101X, FG102M, FG102X, FG105M, FG105X, FG110M, FG110X, FG210M, FG210X, GC010M, GC020M, GC106M, GC110M...(Other models you can see in the webshop)		
<b>accessories for</b>	347706		
	<b>GEV No.</b>	<b>Ref. No.</b>	301036
			9410001
	protective cover internal size 30x22mm for rocker switch mounting measurementsmm		

labelled			
			
<b>GEV No.</b>	301200	<b>Ref. No.</b>	65260050 LAR65260050
<b>description</b>	rocker switch mounting measurements 30x22mm black 2NO 230V 16A 0-1 connection male faston 6.3mm ambient temperature max. 85°C protection IP65 with cover cap		
<b>For models:</b>	AC04, AC05, AC08, AC10, AC20, AU04, AU05, AU08, AU10, AU20, CG210M, EC020M, EC106M, EC110M, EC210M, EM020M, EM106M, EM110M, EM210M, EV006M, EV010M, EV106M, EV110M, EV210M, FE051X, FE101X, FE102X, FE105X, FE110X, FE210X, FG051X, FG101X, FG102X, FG105X, FG110X, FG210X, GC010M, GC020M, GC106M, GC110M, GC210M, GM020M, GM106M, GM110M, GM210M, GV010M, GV106M, GV110M, GV210M, PE040X...(Other models you can see in the webshop)		
<b>accessories for</b>	301200		
	<b>GEV No.</b>	<b>Ref. No.</b>	301036
			9410001
	protective cover internal size 30x22mm for rocker switch mounting measurementsmm		





			
1			
<b>GEV No.</b>	300125	<b>Ref. No.</b>	4640500 50304671 941003 LAR50304671
<b>description</b>	rocker switch mounting measurements 30x22mm green 2NO 230V 16A 0-I connection male faston 6.3mm ambient temperature max. 125/55°C protection IP65 with cover cap		
<b>For models:</b>	FV03, FV06, ME05, ME10, ME15, ME20, ME21, ME24, ME40, MG05, MG10, MG15, MG20, MG21, MG24, MG40, PE04		
<b>accessories for</b>	300125		
	<b>GEV No.</b>	301036	<b>Ref. No.</b> 9410001
protective cover internal size 30x22mm for rocker switch mounting measurementsmm			



			
1			
<b>GEV No.</b>	301164	<b>Ref. No.</b>	MA4640500
<b>description</b>	rocker switch mounting measurements 30x22mm green 2NO 250V 16A illuminated connection male faston 6.3mm ambient temperature max. 85°C protection IP65 with cover cap		
<b>accessories for</b>	301164		
	<b>GEV No.</b>	301036	<b>Ref. No.</b> 9410001
protective cover internal size 30x22mm for rocker switch mounting measurementsmm			

with symbol			
			
1			
<b>GEV No.</b>	301228	<b>Ref. No.</b>	50304650 65260210 LAR50304650 LAR65260210
<b>description</b>	rocker switch mounting measurements 30x22mm black 2CO 250V 16A I-II connection male faston 6.3mm ambient temperature max. 125/55°C protection IP65 with cover cap		
<b>For models:</b>	FE051X, FE101X, FE102X, FE105X, FE110X, FE210X, FG051X, FG101X, FG102X, FG105X, FG110X, FG210X, ICEM023, ICEM041, ICEM051, ICEM071, ICEM101, ICGM051, ICGM071, ICGM101, ME05, ME10, ME15, ME20, ME21, ME24, ME40, MG05, MG10, MG15, MG20, MG21, MG24, MG40, MME05, MME10, MME40, PE04, PE040X, PE041X, PE051X, PE08, PE080X, PE081X, PE101X, PE12, PG040X, PG041X, PG051X, PG080X...(Other models you can see in the webshop)		
<b>accessories for</b>	301228		
	<b>GEV No.</b>	301036	<b>Ref. No.</b> 9410001
protective cover internal size 30x22mm for rocker switch mounting measurementsmm			

## push/momentary push switches

30x22mm			
			
1			
<b>GEV No.</b>	301036	<b>Ref. No.</b>	9410001
<b>description</b>	protective cover internal size 30x22mm for rocker switch mounting measurementsmm		

ø16mm			
			
1			
<b>GEV No.</b>	301172	<b>Ref. No.</b>	65260610 LAR65260610
<b>description</b>	momentary push switch mounting ø 16mm black 1NO 250V 16A connection male faston 6.3mm protection IP40 ambient temperature max. 150°C		
<b>For models:</b>	ACE04M, ACE05M, ACE10M, ACG10M, APE06, APE07, APG08M, APG10M, BPE044M, BPE054M, BPE064M, BPE074M, BPE084M, BPE104M, BPG044M, BPG054M, BPG064M, BPG074M, BPG084M, BPG104M, CE041M, CE051M, CE071M, CE100M, CE200M, CG051M, CG071M, CG100M, CG200M, MACE04M, MACE05M, MACE07M, MACE10M, MACE20M, MACG05M, MACG07M, MACG10M, MACG20M, MCE042M, MCE051M, MCE071M, MCE101M, MCE102M, MCE201M, MCE202M, MCG051M, MCG071M, MCG101M, MCG102M, MCG201M... (Other models you can see in the webshop)		

			
1			
<b>GEV No.</b>	346345	<b>Ref. No.</b>	6032020
<b>description</b>	momentary push switch mounting ø 16mm black 1NO 250V 3A connection male faston 2.8mm ambient temperature max. 85°C protection IP40		
<b>For models:</b>	VE102MX		
<b>accessories for</b>	346345		
	<b>GEV No.</b>	346343	<b>Ref. No.</b> 6032021
protective cover			
	<b>GEV No.</b>	346344	<b>Ref. No.</b> 6032022
ring for protecting cover			





 <p>1</p>			
<b>GEV No.</b>	346287 <sup>1</sup>	<b>Ref. No.</b>	65260480 LAR65260480
<b>description</b>	momentary push switch mounting ø 16mm red 1NO 250V 3A illuminated connection male faston 2.8mm ambient temperature max. 125/55°C protection IP65 with cover cap		
<b>For models:</b>	CG106M, CG210M, FG051M, FG051X, FG101M, FG101X, FG102M, FG102X, GC010M, GC020M, GC106M, GC110M, GC210M, GM020H, GM020M, GM106H, GM106M, GM106M+SC, GM106P, GM110H, GM110M, GM110M+SC, GM110P, GM210H, GM210M, GM210M+SC, GM210P, GV006H, GV006M, GV010H, GV010M, GV020H, GV106H, GV106M, GV106M+SC, GV106P, GV110H, GV110M, GV110M+SC, GV110P, GV210H, GV210M, GV210M+SC, GV210P, MG106D, MG106M, MG106X, MG110D, MG110M, MG110X...(Other models you can see in the webshop)		



<sup>1</sup>illuminated

 <p>2</p>			
<b>GEV No.</b>	301227	<b>Ref. No.</b>	65260120 65260600 LAR65260120 LAR65260600
<b>description</b>	push switch mounting ø 16mm black 1NO 250V 16A connection male faston 6.3mm protection IP40 ambient temperature max. 150°C		
<b>For models:</b>	ABG064M, ABG074M, ACE04M, ACE05M, ACE10M, ACG10M, APE06, APE07, APG08M, APG10M, BPE044M, BPE054M, BPE064M, BPE074M, BPE084M, BPE104M, BPG044M, BPG054M, BPG064M, BPG074M, BPG084M, BPG104M, CE041M, CE051M, CE071M, CE100M, CE106M, CE110M, CE200M, CE210M, CEC40M, CES24M, CES40M, CG051M, CG071M, CG100M, CG106M, CG110M, CG200M, CGC24M, CGC40M, CGS24M, CGS40M, MACE04M, MACE05M, MACE07M, MACE10M, MACE20M, MACG05M, MACG07M...(Other models you can see in the webshop)		

ø25mm

 <p>1</p>			
<b>GEV No.</b>	345160 <sup>1</sup>	<b>Ref. No.</b>	R65260500
<b>description</b>	push switch mounting ø 25mm red 2NO 250V 16A illuminated connection male faston 6.3mm ambient temperature max. 85°C protection IP40		



<sup>1</sup>illuminated



 <p>1</p>			
<b>GEV No.</b>	346318	<b>Ref. No.</b>	R65260500
<b>description</b>	momentary push switch mounting ø 25mm red 1NO 250V 16A with cover cap ignition connection male faston 6.3mm ambient temperature max. 85°C protection IP65		
<b>accessories for</b>	346318		
	<b>GEV No.</b>	<b>Ref. No.</b>	—
	345039		
	protective cover round ED ø 33mm external size 23mm internal size 21mm H 12mm clear mounting ø 25mm		

 <p>1</p>			
<b>GEV No.</b>	348211	<b>Ref. No.</b>	65260500 LAR65260500
<b>description</b>	momentary push switch mounting ø 25mm red 1NO/indicator light 250V 16A illuminated connection male faston 6.3mm ambient temperature max. 85°C protection IP65 with cover		
<b>For models:</b>	VG105S, VG106L, VG106S, VG106T, VG110L, VG110S, VG110T, VG210L, VG210S, VG210T		

accessories

protective covers

 <p>1</p>			
<b>GEV No.</b>	346343	<b>Ref. No.</b>	6032021
<b>description</b>	protective cover		
<b>For models:</b>	VE102MX		
<b>accessories for</b>	346343		
	<b>GEV No.</b>	<b>Ref. No.</b>	6032022
	346344		
	ring for protecting cover		

 <p>1</p>			
<b>GEV No.</b>	346344	<b>Ref. No.</b>	6032022
<b>description</b>	ring for protecting cover		
<b>For models:</b>	VE102MX		
<b>accessories for</b>	346344		
	<b>GEV No.</b>	<b>Ref. No.</b>	6032021
	346343		
	protective cover		

microswitches

lever actuated

 <p>1</p>			
<b>GEV No.</b>	345254	<b>Ref. No.</b>	1037111300
<b>description</b>	microswitch with lever 250V 16A 1CO connection male faston 6.3mm ambient temperature max. 120°C mounting distance 22mm actuating force: 60g lever length 58mm		



## pin-plunger actuated



<b>GEV No.</b>	348212	<b>Ref. No.</b>	65260900 LAR65260900 LAR65260900K
<b>description</b>	microswitch kit 250V 6A for combi-steamer		
<b>For models:</b>	AREN064, AREN084, ARES064, ARES084, ARGN064, ARGN084, ARGS064, ARGS084, NAEB071, NAEB071R, NAEB072R, NAEB101, NAEB101R, NAEB102, NAEB102R, NAEB072, NAEV071, NAEV071R, NAEV072, NAEV072R, NAEV101, NAEV101R, NAEV102, NAEV102R, NAGB071, NAGB071R, NAGB072, NAGB072R, NAGB101, NAGB101R, NAGB102, NAGB102R, NAGV071, NAGV071R, NAGV072, NAGV072R, NAGV101, NAGV101R, NAGV102, NAGV102R, SAEB071, SAEB072, SAEB101, SAEB102, SAEV071, SAEV072, SAEV101, SAEV102, SAGB071, SAGB072...(Other models you can see in the webshop)		

## M10



<b>GEV No.</b>	347603	<b>Ref. No.</b>	A34100910
<b>description</b>	microswitch with plunger thread M10x0.75 thread L 10mm 250V 16A 1CO connection male faston 6.3mm stroke 5mm mounting distance 22mm L 29mm ambient temperature max. 125°C type VRSR01DZ2 actuating force: 170g		



<b>GEV No.</b>	346347	<b>Ref. No.</b>	6043088
<b>description</b>	microswitch with plunger thread M10x0.75 thread L 14mm 250V 6A 2NO connection male faston 6.3mm stroke 4mm mounting distance 22mm ambient temperature max. 85°C actuating force: 100g		
<b>For models:</b>	VE102MX		



<b>GEV No.</b>	345032	<b>Ref. No.</b>	65260540 LAR65260540
<b>description</b>	microswitch with plunger thread M10x1 thread L 12mm 250V 16A 1CO connection male faston 6.3mm stroke 7mm mounting distance 22mm L 28mm ambient temperature max. 125°C type SP9603 actuating force: 180g		
<b>For models:</b>	A05PES, A05PES+UM, A05RES, A05RES+UM, A08PES, A08PES+UM, A08RES, A08RES+UM, A10PES, A10PES+UM, A10RES, A10RES+UM, ABE044M, ABE054M, ABE084S, ABE104S, ABG064M, ABG074M, ABG084X, ABG104X, ACE04M, ACE05M, ACE10M, ACG10M, AME07D, AME07P, AME10D, APE06, APE07, APG08M, APG10M, AVE07D, AVE07P, AVE10D, AVE10P, AVG05P, AVG10D, AVG20D, BPE044M, BPE044P, BPE054M, BPE054P, BPE064M, BPE064P, BPE074M, BPE074P, BPE084M, BPE084P, BPE104M, BPE104P...(Other models you can see in the webshop)		

## M12



<b>GEV No.</b>	345350	<b>Ref. No.</b>	50304530 65260530 LAR50304530 LAR65260530
<b>description</b>	microswitch with plunger mounting distance 22mm thread M12x0.75 thread L 16mm 250V 16A 1CO connection male faston 6.3mm stroke 4mm ambient temperature max. 125°C type EF83161.3 actuating force: 66g		
<b>For models:</b>	CBEN061, CBES061, CEV026S, CEV026X, CEV061S, CEV061X, CEV101S, CEV101X, CG105M, CME061S, CME061X, COEN026, COEN061, COEN101, COES026, COES061, COES101, CVE004H, CVE004M, CVE024S, CVE024X, CVE061S, CVE061X, CVE104H, CVE104M, CVE105H, CVE105M, CVEN061, CVES061, CVG061S, CVG061X, CVG105H, CVG105M, CVGN061, CVGS061, FE05, FG05, FV03, FV06, ICEM023, ICEM041, ICEM051, ICEM071, ICEM101, ICET023, ICET041, ICET051, ICET071, ICET101, ICGM051...(Other models you can see in the webshop)		
<b>accessories for</b>	345350		
	<b>GEV No.</b>	345351	<b>Ref. No.</b> —

## float switches

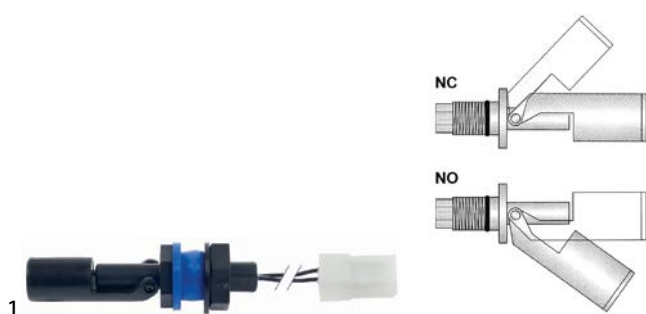

<b>GEV No.</b>	348166	<b>Ref. No.</b>	65260910 LA65260910 LAR65260910
<b>description</b>	float switch thread M16x1.5 1NO or 1NC ø 16mm L 88mm mounting ø 16mm 250V 1A cable cable length 520mm with gasket and nut		
<b>For models:</b>	AREN064, AREN084, ARES064, ARES084, ARGN064, ARGN084, ARGS064, ARGS084, NAEB071, NAEB071R, NAEB072R, NAEB101, NAEB101R, NAEB102, NAEB102R, NAEB072, NAEV071, NAEV071R, NAEV072, NAEV072R, NAEV101, NAEV101R, NAEV102, NAEV102R, NAGB071, NAGB071R, NAGB072, NAGB072R, NAGB101, NAGB101R, NAGB102, NAGB102R, NAGV071, NAGV071R, NAGV072, NAGV072R, NAGV101, NAGV101R, NAGV102, NAGV102R, SAEB071, SAEB072, SAEB101, SAEB102, SAEV071, SAEV072, SAEV101, SAEV102, SAGB071, SAGB072...(Other models you can see in the webshop)		



cam switches

4 operating positions

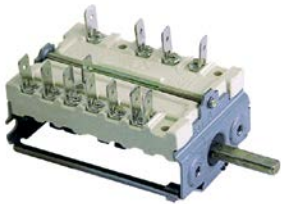

1

<b>GEV No.</b>	300010	<b>Ref. No.</b>	50304020 65080010 LA65080010 LAR50304020 LAR65080010
<b>description</b>	cam switch 4 operating positions 2NO/2CO sequence 0-1-2-3 16A shaft $\varnothing$ 6x4.6mm shaft L 23mm connection male faston 6.3mm ceramic		
<b>For models:</b>	ABE044M, ABE054M, ABG064M, ABG074M, ACE04M, ACE05M, ACE10M, ACG10M, APE06, APE07, APG08M, APG10M, BPE044M, BPE054M, BPE064M, BPE074M, BPE084M, BPE104M, BPG044M, BPG054M, BPG064M, BPG074M, BPG084M, BPG104M, CE041M, CE051M, CE071M, CE100M, CE106M, CE110M, CE200M, CE210M, CEC40M, CES24M, CES40M, CG051M, CG071M, CG100M, CG106M, CG110M, CG200M, CG210M, CGC40M, CGS24M, CGS40M, EC020M, EC106M, EC110M, EC210M, FE05...(Other models you can see in the webshop)		

5 operating positions



1

<b>GEV No.</b>	347191	<b>Ref. No.</b>	65080020 LA65080020 LAR65080020
<b>description</b>	cam switch 5 operating positions 9NO sequence 1-0-2-3-4 16A shaft $\varnothing$ 6x4.6mm shaft L 23mm connection male faston 6.3mm plastic		
<b>For models:</b>	CG105M, CGC24M, CVE004M, CVE104M, CVE105M, CVG105M, EM006M+SC, EM010M+SC, EM020M, EM106M, EM106M+SC, EM110M, EM110M+SC, EM210M, EM210M+SC, EV006M, EV010M, EV020M, EV106M, EV106M+SC, EV110M, EV110M+SC, EV210M, EV210M+SC, FME61A, FME61S, FMG201A, FMG201S, GM020M, GM106M, GM106M+SC, GM110M, GM110M+SC, GM210M, GM210M+SC, GV006M, GV010M, GV106M, GV106M+SC, GV110M, GV110M+SC, GV210M, GV210M+SC, ICEM023, ICEM041, ICEM051, ICEM071, ICEM101, ICGM051, ICGM071...(Other models you can see in the webshop)		

8 operating positions

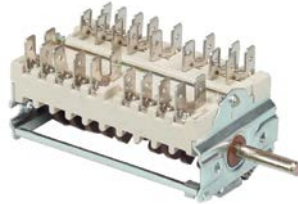

1

<b>GEV No.</b>	301225	<b>Ref. No.</b>	65080060 LA65080060 LAR65080060
<b>description</b>	cam switch 8 operating positions sequence 0-1-2-3-4-5-6-7 shaft $\varnothing$ 6x4.6mm connection male faston 8-pole		
<b>For models:</b>	ME106L, ME110L, ME120L, ME210L, ME220L, MG106L, MG110L, MG120L, MG210L, MG220L, PE105M, PE108M, PE115M, PE188M		

operation switches



1

<b>GEV No.</b>	300002	<b>Ref. No.</b>	6046001
<b>description</b>	cam switch 2 operating positions 4NO 16A sequence 0-1 shaft $\varnothing$ 6x4.6mm shaft L 23mm connection male faston 6.3mm ceramic		



1

<b>GEV No.</b>	300080	<b>Ref. No.</b>	710300
<b>description</b>	cam switch 2 operating positions 4NO 16A sequence 0-1 shaft $\varnothing$ 6x4.6mm shaft L 23mm connection screw operation switch ceramic ambient temperature max. 150°C		
<b>accessories for</b>	300080		
	<b>GEV No.</b>	551456	<b>Ref. No.</b> —
gasket for switch ED $\varnothing$ 14mm ID $\varnothing$ 2.5mm thickness 3.5mm white			

rotary switches

BREMAS

A1600 series



1

<b>GEV No.</b>	346342	<b>Ref. No.</b>	6030031
<b>description</b>	rotary switch 7 1-2-3-4-5-6-7 sets of contacts 9 type CS0169137 400V 16A shaft $\varnothing$ 4x5mm shaft L 20mm shaft square connection screw		
<b>For models:</b>	VE102MX		



## touch sensitive light switches

			
1			
<b>GEV No.</b>	346388	<b>Ref. No.</b>	65260750 LAR65260750
<b>description</b>	touch sensitive light switch 1NOVA for combi-steamer L 47mm W 20mm H 30mm		
<b>For models:</b>	ABE084S, ABE104S, ABE156X, ABG064M, ABG074M, ABG084X, ABG104X, ABG156S, ACE10M, ACG10M, AME07D, AME07P, AME10D, APE06, APE07, APG08M, APG10M, AVE07D, AVE07P, AVE10D, AVE10P, AVG10D, AVG20D, BPE064M, BPE064P, BPE074M, BPE074P, BPE084M, BPE084P, BPE104M, BPE104P, BPG064M, BPG064P, BPG074M, BPG074P, BPG084M, BPG084P, BPG104M, BPG104P, CE071M, CE100M, CE200M, CG071M, CG100M, CG200M, CKES10, EMT06D, EMT10D, EMT20P, EMT21P...(Other models you can see in the webshop)		

## magnetic switches

37x16mm

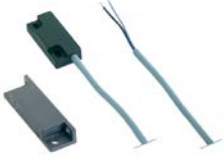
			
1			
<b>GEV No.</b>	347790	<b>Ref. No.</b>	65265100 LAR65265100
<b>description</b>	magnetic switch L 37mm W 16mm 1NO 250V connection cable cable length 1960mm 10W with magnet nominal 0.04A		
<b>For models:</b>	ABE156X, ABG156S, AREN064, AREN084, AREN154, ARES064, ARES084, ARES154, ARGN064, ARGN084, ARGN154, ARGS064, ARGS084, ARGS154, CEC40M, CES24M, CES40M, CGC24M, CGC40M, CGS24M, CGS40M, CKES10, EMT06D, EMT10D, EMT20P, EMT21P, EPE056T, EPE086T, EPE156T, EPEV05T, EPEV08T, EPEV15T, EPG056T, EPG086T, EPG156T, EPGV05T, EPGV08T, EPGV15T, EVT06D, EVT06P, EVT10P, EVT20D, FEI102P, FME101AX, FME201SX, FME61A, FME61S, FMG201A, FMG201S, GEMT06P...(Other models you can see in the webshop)		

## miscellaneous

			
1			
<b>GEV No.</b>	401961	<b>Ref. No.</b>	66110300 LAR66110300
<b>description</b>	magnetic switch door contact		
<b>For models:</b>	ABE156X, ABG156S, ACE10M, ACG10M, AME07D, AME07P, AME10D, APE06, APE07, APG08M, APG10M, AVE07D, AVE07P, AVE10D, AVE10P, AVG10D, AVG20D, BPE064M, BPE064P, BPE074M, BPE074P, BPE084M, BPE084P, BPE104M, BPE104P, BPG064M, BPG064P, BPG074M, BPG074P, BPG084M, BPG084P, BPG104M, BPG104P, CE071M, CE100M, CE200M, CG071M, CG100M, CG200M, EMT06D, EMT10D, EMT20P, EMT21P, EPE056T, EPE086T, EPE156T, EPEV05T, EPEV08T, EPEV15T, EPG056T...(Other models you can see in the webshop)		

## control equipment

## MOELLER/EATON

## switches (complete)

## rotary switches

			
1			
<b>GEV No.</b>	346461	<b>Ref. No.</b>	65080150 LAR65080150
<b>description</b>	rotary switch mounting measurements ø22mm black latching 1NC/1NO sequence 0-1		
<b>For models:</b>	ABG064M, ABG074M, APE06, APE07, APG08M, APG10M, BPE064M, BPE074M, BPE084M, BPE104M, BPG064M, BPG074M, BPG084M, BPG104M, MME071P, PE064M, PE074M, PE084M, PE104M, PG084, PG104M		

## encoders and potentiometers

			
1			
<b>GEV No.</b>	401338	<b>Ref. No.</b>	65301450 65321450 LAR65301450 LAR65321450
<b>description</b>	encoder		
<b>For models:</b>	AME07D, AME07P, AME10D, AVE07D, AVE07P, AVE10D, AVE10P, AVG05P, AVG10D, AVG20D, BPE044P, BPE054P, BPE064P, BPE074P, BPE084P, BPE104P, BPG044P, BPG054P, BPG064P, BPG074P, BPG084P, BPG104P, EMT06D, EMT10D, EMT20P, EMT21P, EPE056T, EPE086T, EPE156T, EPEV05T, EPEV08T, EPEV15T, EPG056T, EPG086T, EPG156T, EPGV05T, EPGV08T, EPGV15T, EVT06D, EVT06P, EVT10P, EVT20D, GEMT06P, GEMT06T, GEMT10P, GEMT10T, GEMT20P, GEMT20T, GEMT21P, GEMT21T...(Other models you can see in the webshop)		

			
1			
<b>GEV No.</b>	403835	<b>Ref. No.</b>	65302500 LA65302500 R65302500
<b>description</b>	encoder rotation 360° shaft ø 6x4.6mm shaft L 26mm for combi-steamer cable length 600mm SS		
<b>For models:</b>	AREN064, AREN084, AREN154, ARGN064, ARGN084, ARGN154, CBEN061, COEN026, COEN061, COEN101, CVEN061, CVGN061, LBET071, LBET072, LBET101, LBET102, LBET201, LBET202, LBGT071, LBGT072, LBGT101, LBGT102, LBGT201, LBGT202, LVET071, LVET072, LVET101, LVET102, LVET201, LVET202, LVGT071, LVGT072, LVGT101, LVGT102, LVGT201, LVGT202, NAEB071, NAEB101, NAEB102, NAEB201, NAEB202, NAEBO72, NAEV071, NAEV072, NAEV101, NAEV102, NAEV201, NAEV202, NAGB071, NAGB072...(Other models you can see in the webshop)		



			
<b>GEV No.</b>	403084	<b>Ref. No.</b>	65301940 65301941 LA65301941 LAR65301940 LAR65301941
<b>description</b>	encoder shaft L 18mm cable length 200mm shaft 6x4.6mm		
<b>For models:</b>	ABE084S, ABE104S, ABE156X, ABG084X, ABG104X, ABG156S, ARES064, ARES084, ARES154, ARG064, ARG084, ARG154, CBES061, CEV026S, CEV026X, CEV061S, CEV061X, CEV101S, CEV101X, CKES10, CME061S, CME061X, COES026, COES061, COES101, CVE024S, CVE024X, CVE061S, CVE061X, CVES061, CVG061S, CVGS061, EVEA20S, GEMT07S, GEMT07X, GEMT10S, GEMT10X, GEMT20S, GEMT20X, GEMT21S, GEMT21X, GEMT40S, GEMT40X, GEVT06S, GEVT07S, GEVT07X, GEVT10S, GEVT10X, GEVT20S, GEVT20X...(Other models you can see in the webshop)		

			
<b>GEV No.</b>	300187	<b>Ref. No.</b>	6010097
<b>description</b>	potentiometer 4.7kOhm rotation 310° shaft ø 0.6x4.5mm shaft L 20mm cable length 650mm		
<b>For models:</b>	VE102MX		

## lamps

### indicator lights

#### indicator lights (complete)

ø10mm

with screw socket

			
<b>GEV No.</b>	359378	<b>Ref. No.</b>	1037300810 MA1037300810
<b>description</b>	indicator light ø 10mm 230V green connection male faston 6.3mm socket screw base		

			
<b>GEV No.</b>	359379	<b>Ref. No.</b>	587500 CR0587500
<b>description</b>	indicator light ø 10mm 230V yellow connection male faston 6.3mm socket screw base		

with plug-in socket

			
<b>GEV No.</b>	359140	<b>Ref. No.</b>	1037300910
<b>description</b>	indicator light ø 10mm yellow 230V connection male faston 6.3mm Qty 1 pcs		

ø12mm

with screw socket

			
<b>GEV No.</b>	359026	<b>Ref. No.</b>	50304620 LAR50304620
<b>description</b>	indicator light ø 12mm 230V red connection male faston 6.3mm model CM/5		
<b>For models:</b>	FE04, FE05, FG05, FV03, FV06, MME05, MME10		

			
<b>GEV No.</b>	359027	<b>Ref. No.</b>	50304630 65270230 LAR50304630 LAR65270230
<b>description</b>	indicator light ø 12mm 250V green connection male faston 6.3mm		
<b>For models:</b>	CE106M, CE110M, CE210M, CEC40M, CES24M, CES40M, CG105M, CG106M, CG110M, CG210M, CGC24M, CGC40M, CGS24M, CGS40M, CVE004M, CVE104M, CVE105M, CVG105M, ECO20M, EC106M, EC110M, EC210M, EM006M+SC, EM010M+SC, EM020M, EM106M, EM106M+SC, EM110M, EM110M+SC, EM210M, EM210M+SC, EV006M, EV010M, EV020M, EV106M, EV106M+SC, EV110M, EV110M+SC, EV210M, EV210M+SC, FE04, FE051M, FE051X, FE101M, FE101X, FE102M, FE102X, FE105M, FE105X, FE110M...(Other models you can see in the webshop)		

			
<b>GEV No.</b>	359291	<b>Ref. No.</b>	0101169 SIO101169 SIR0101169
<b>description</b>	indicator light ø 12mm 400V green connection male faston 6.3mm		

			
<b>GEV No.</b>	359290	<b>Ref. No.</b>	0101167 65270220 LA65270220 LAR65270220 SIR0101167
<b>description</b>	indicator light ø 12mm 400V yellow connection male faston 6.3mm		
<b>For models:</b>	AC04, AC05, AC08, AC10, AC20, AU04, AU05, AU08, AU10, AU20, CE106M, CE110M, CE210M, CEC40M, CES24M, CES40M, CG105M, CG106M, CG110M, CG210M, CGC24M, CGC40M, CGS24M, CGS40M, CVE004M, CVE104M, CVE105M, CVG105M, ECO20M, EC106M, EC110M, EC210M, EM006M+SC, EM010M+SC, EM020M, EM106M, EM106M+SC, EM110M, EM110M+SC, EM210M, EM210M+SC, EV006M, EV010M, EV020M, EV106M, EV106M+SC, EV110M, EV110M+SC, EV210M, EV210M+SC...(Other models you can see in the webshop)		





ø16mm

with plug-in socket



1

<b>GEV No.</b>	359788	<b>Ref. No.</b>	65270160 LAR65270160
<b>description</b>	indicator light ø 16mm 230V green connection male faston 6.3mm		
<b>For models:</b>	ABG064M, ABG074M, ACE04M, ACE05M, ACE10M, ACG10M, APE06, APE07, APG08M, APG10M, BPE044M, BPE054M, BPE064M, BPE074M, BPE084M, BPE104M, BPG044M, BPG054M, BPG064M, BPG074M, BPG084M, BPG104M, CE041M, CE051M, CE071M, CE100M, CE200M, CG051M, CG071M, CG100M, CG200M, MACE04M, MACE05M, MACE07M, MACE10M, MACE20M, MACG05M, MACG07M, MACG10M, MACG20M, MCE042M, MCE071M, MCE101M, MCE102M, MCE201M, MCE202M, MCG071M, MCG101M, MCG102M, MCG201M...(Other models you can see in the webshop)		



1

<b>GEV No.</b>	359789	<b>Ref. No.</b>	65270150 LAR65270150
<b>description</b>	indicator light ø 16mm 230V yellow connection male faston 6.3mm		
<b>For models:</b>	ABG064M, ABG074M, ACE04M, ACE05M, ACE10M, ACG10M, APE06, APE07, APG08M, APG10M, BPE044M, BPE054M, BPE064M, BPE074M, BPE084M, BPE104M, BPG044M, BPG054M, BPG064M, BPG074M, BPG084M, BPG104M, CE041M, CE051M, CE071M, CE100M, CE200M, CG051M, CG071M, CG100M, CG200M, MACE04M, MACE05M, MACE07M, MACE10M, MACE20M, MACG05M, MACG07M, MACG10M, MACG20M, MCE042M, MCE071M, MCE101M, MCE102M, MCE201M, MCE202M, MCG071M, MCG101M, MCG102M, MCG201M...(Other models you can see in the webshop)		

## screw-on/push-on fit

## light bulbs

for ovens



1

<b>GEV No.</b>	357153	<b>Ref. No.</b>	65270120 LAR65270120
<b>description</b>	light bulb t.max. 300°C socket E14 25W 230V ø 25mm L 55mm lens L 30mm for oven type		

## halogen lamp

for socket G4 / G6.35 / G9



1

<b>GEV No.</b>	359599	<b>Ref. No.</b>	50304520 6061054 65270020 LA65270020 LAR50304520 LAR65270020
<b>description</b>	halogen lamp socket G4 12V 20W temp.-resist. 500°C		
<b>For models:</b>	ABE084S, ABE104S, ABE156X, ABG064M, ABG074M, ABG084X, ABG104X, ABG156S, ACE10M, ACG10M, AME07D, AME07P, AME10D, APE06, APE07, APG08M, APG10M, AREN064, AREN084, AREN154, ARES064, ARES084, ARES154, ARGN064, ARGN084, ARGN154, ARGS064, ARGS084, ARGS154, AVE07D, AVE07P, AVE10D, AVE10P, AVG10D, AVG20D, BPE064M, BPE064P, BPE074M, BPE074P, BPE084M, BPE084P, BPE104M, BPE104P, BPG064M, BPG064P, BPG074M, BPG074P, BPG084M, BPG084P, BPG104M...(Other models you can see in the webshop)		



1

<b>GEV No.</b>	359946	<b>Ref. No.</b>	65270130 R65270130
<b>description</b>	halogen lamp socket G9 230V 40W temp.-resist. 300°C		

## oven lamps

## universal oven lamps

30x70mm



1

<b>GEV No.</b>	359338	<b>Ref. No.</b>	6063077
<b>description</b>	lamp glass		
<b>For models:</b>	VE102MX		



1

<b>GEV No.</b>	359337	<b>Ref. No.</b>	6063075
<b>description</b>	oven lamp socket G4 cable length 800mm connection Faston 6.3mm L 70mm W 29mm		
<b>For models:</b>	VE102MX		
<b>accessories for</b>	359337		



1

<b>GEV No.</b>	359599	<b>Ref. No.</b>	50304520 6061054 65270020 LA65270020 LAR50304520 LAR65270020 R50304520 R65270020
<b>description</b>	halogen lamp socket G4 12V 20W temp.-resist. 500°C		

55x70mm			
			
1			
<b>GEV No.</b>	357159	<b>Ref. No.</b>	65270500 LA65270500 LAR65270500
<b>description</b>	lamp socket socket E14 mounting measurements 55x70mm connection male faston 6.3mm Qty 1 pcs		
<b>For models:</b>	A05PES, A05RES, A08PES, A08RES, A10PES, A10RES		

			
1			
<b>GEV No.</b>	357159	<b>Ref. No.</b>	65270500 LA65270500 LAR65270500
<b>description</b>	lamp socket socket E14 mounting measurements 55x70mm connection male faston 6.3mm Qty 1 pcs		
<b>For models:</b>	A05PES, A05RES, A08PES, A08RES, A10PES, A10RES		

producer-specific oven lamps

LAINOX			
			
1			
<b>GEV No.</b>	359672	<b>Ref. No.</b>	11401450 LA11401450 LAR11401450
<b>description</b>	frame		
<b>For models:</b>	ABE084S, ABE104S, ABE156X, ABG064M, ABG074M, ABG084X, ABG104X, ABG156S, ACE10M, ACG10M, AME07D, AME07P, AME10D, APE06, APE07, APG08M, APG10M, AREN064, AREN084, AREN154, ARES064, ARES084, ARES154, ARGN064, ARGN084, ARGN154, ARGS064, ARGS084, ARGS154, AVE07D, AVE07P, AVE10D, AVE10P, AVG10D, AVG20D, BPE064M, BPE064P, BPE074M, BPE074P, BPE084M, BPE084P, BPE104M, BPE104P, BPG064M, BPG064P, BPG074M, BPG074P, BPG084M, BPG084P, BPG104M...(Other models you can see in the webshop)		

			
1			
<b>GEV No.</b>	359671	<b>Ref. No.</b>	70044200 LA70044200 LAR70044200
<b>description</b>	gasket		
<b>For models:</b>	ABE084S, ABE104S, ABE156X, ABG064M, ABG074M, ABG084X, ABG104X, ABG156S, ACE10M, ACG10M, AME07D, AME07P, AME10D, APE06, APE07, APG08M, APG10M, AREN064, AREN084, AREN154, ARES064, ARES084, ARES154, ARGN064, ARGN084, ARGN154, ARGS064, ARGS084, ARGS154, AVE07D, AVE07P, AVE10D, AVE10P, AVG10D, AVG20D, BPE064M, BPE064P, BPE074M, BPE074P, BPE084M, BPE084P, BPE104M, BPE104P, BPG064M, BPG064P, BPG074M, BPG074P, BPG084M, BPG084P, BPG104M...(Other models you can see in the webshop)		

			
1			
<b>GEV No.</b>	359670	<b>Ref. No.</b>	71500150 LA71500150 LAR71500150
<b>description</b>	lamp glass L 105mm W 40mm thickness 4mm		
<b>For models:</b>	ABE084S, ABE104S, ABE156X, ABG064M, ABG074M, ABG084X, ABG104X, ABG156S, ACE10M, ACG10M, AME07D, AME07P, AME10D, APE06, APE07, APG08M, APG10M, AREN064, AREN084, AREN154, ARES064, ARES084, ARES154, ARGN064, ARGN084, ARGN154, ARGS064, ARGS084, ARGS154, AVE07D, AVE07P, AVE10D, AVE10P, AVG10D, AVG20D, BPE064M, BPE064P, BPE074M, BPE074P, BPE084M, BPE084P, BPE104M, BPE104P, BPG064M, BPG064P, BPG074M, BPG074P, BPG084M, BPG084P, BPG104M...(Other models you can see in the webshop)		

			
1			
<b>GEV No.</b>	359674	<b>Ref. No.</b>	65270450 LA65270450 LAR65270450
<b>description</b>	lamp socket 24V socket G4 connection cable 100mm ømm H 16mm with 2 hole fixing mounting distance 20mm holder length 26mm Qty 1 pcs		
<b>For models:</b>	ABE084S, ABE104S, ABE156X, ABG064M, ABG074M, ABG084X, ABG104X, ABG156S, ACE10M, ACG10M, AME07D, AME07P, AME10D, APE06, APE07, APG08M, APG10M, AREN064, AREN084, AREN154, ARES064, ARES084, ARES154, ARGN064, ARGN084, ARGN154, ARGS064, ARGS084, ARGS154, AVE07D, AVE07P, AVE10D, AVE10P, AVG10D, AVG20D, BPE064M, BPE064P, BPE074M, BPE074P, BPE084M, BPE084P, BPE104M, BPE104P, BPG064M, BPG064P, BPG074M, BPG074P, BPG084M, BPG084P, BPG104M...(Other models you can see in the webshop)		

			
1			
<b>GEV No.</b>	359673	<b>Ref. No.</b>	11401440 LA11401440 LAR11401440
<b>description</b>	lamp socket socket G4 mounting measurements 37x103mm		
<b>For models:</b>	ABE084S, ABE104S, ABE156X, ABG064M, ABG074M, ABG084X, ABG104X, ABG156S, ACE10M, ACG10M, AME07D, AME07P, AME10D, APE06, APE07, APG08M, APG10M, AREN064, AREN084, AREN154, ARES064, ARES084, ARES154, ARGN064, ARGN084, ARGN154, ARGS064, ARGS084, ARGS154, AVE07D, AVE07P, AVE10D, AVE10P, AVG10D, AVG20D, BPE064M, BPE064P, BPE074M, BPE074P, BPE084M, BPE084P, BPE104M, BPE104P, BPG064M, BPG064P, BPG074M, BPG074P, BPG084M, BPG084P, BPG104M...(Other models you can see in the webshop)		
<b>spare parts for</b>	359673		
<b>GEV No.</b>	359674	<b>Ref. No.</b>	65270450 LA65270450 LAR65270450 R65270450
<b>description</b>	lamp socket 24V socket G4 connection cable 100mm ømm H 16mm with 2 hole fixing mounting distance 20mm holder length 26mm Qty 1 pcs		



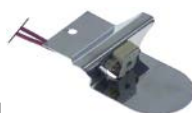

			
<b>GEV No.</b>	359668	<b>Ref. No.</b>	70040800 LAR70040800
<b>description</b>	gasket		
<b>For models:</b>	CE106M, CE110M, CE210M, CEC40M, CES24M, CES40M, CG106M, CG110M, CG210M, CGC24M, CGC40M, CGS24M, CGS40M, FEI102P, FME201SX, FME61S, ME106D, ME106H, ME106L, ME106M, ME106P, ME106T, ME106X, ME110D, ME110H, ME110L, ME110M, ME110P, ME110T, ME110X, ME120H, ME120L, ME120P, ME120X, ME210D, ME210H, ME210L, ME210M, ME210P, ME210T, ME210X, ME220H, ME220L, ME220P, ME220X, ME227P, ME227X, MEC20H, MEC20P, MEC20X...(Other models you can see in the webshop)		

			
<b>GEV No.</b>	357131	<b>Ref. No.</b>	65270400 LAR65270400
<b>description</b>	lamp socket with fixing sheet L 90mm W 65mm socket G4 connection cable 100mm ømm H 21mm mounting distance 20mm for halogen lamp Qty 1 pcs		
<b>For models:</b>	CE106M, CE110M, CE210M, CEC40M, CES24M, CES40M, CG106M, CG110M, CG210M, CGC24M, CGC40M, CGS24M, CGS40M, EC020M, EC106M, EC110M, EC210M, EM006H, EM006M+SC, EM010H, EM010M+SC, EM020M, EM106H, EM106M, EM106M+SC, EM106P, EM110H, EM110M, EM110M+SC, EM110P, EM210H, EM210M, EM210M+SC, EM210P, EV006M, EV006P, EV010H, EV010M, EV010P, EV020M, EV106H, EV106M, EV106M+SC, EV106P, EV110H, EV110M, EV110M+SC, EV110P, EV210H, EV210M...(Other models you can see in the webshop)		

			
<b>GEV No.</b>	359667	<b>Ref. No.</b>	10400150 LAR10400150
<b>description</b>	reflector L 141mm		
<b>For models:</b>	CE106M, CE110M, CE210M, CEC40M, CES24M, CES40M, CG106M, CG110M, CG210M, CGC24M, CGC40M, CGS24M, CGS40M, FE105X, FE110X, FE210X, FEI102P, FG105X, FG110X, FG210X, FME201SX, ME106D, ME106H, ME106M, ME106P, ME106X, ME110D, ME110H, ME110M, ME110P, ME110X, ME120H, ME120P, ME120X, ME210D, ME210H, ME210M, ME210P, ME210X, ME220H, ME220P, ME220X, MEC20H, MEC20P, MEC20X, MEC24H, MEC40H, MEC40M, MEC40P, MED40D...(Other models you can see in the webshop)		

<b>lamps</b>			
<b>light bulbs</b>			
			
<b>GEV No.</b>	357153	<b>Ref. No.</b>	65270120 LAR65270120
<b>description</b>	light bulb t.max. 300°C socket E14 25W 230V ø 25mm L 55mm lens L 30mm for oven type		

<b>halogen lamps</b>			
for socket G4 / G6.35 / G9			
			
<b>GEV No.</b>	359599	<b>Ref. No.</b>	50304520 6061054 65270020 LA65270020 LAR50304520 LAR65270020
<b>description</b>	halogen lamp socket G4 12V 20W temp.-resist. 500°C		
<b>For models:</b>	ABE084S, ABE104S, ABE156X, ABG064M, ABG074M, ABG084X, ABG104X, ABG156S, ACE10M, ACG10M, AME07D, AME07P, AME10D, APE06, APE07, APG08M, APG10M, AREN064, AREN084, AREN154, ARES064, ARES084, ARES154, ARGN064, ARGN084, ARGN154, ARGS064, ARGS084, ARGS154, AVE07D, AVE07P, AVE10D, AVE10P, AVG10D, AVG20D, BPE064M, BPE064P, BPE074M, BPE074P, BPE084M, BPE084P, BPE104M, BPE104P, BPG064M, BPG064P, BPG074M, BPG074P, BPG084M, BPG084P, BPG104M...(Other models you can see in the webshop)		

			
<b>GEV No.</b>	359946	<b>Ref. No.</b>	65270130 R65270130
<b>description</b>	halogen lamp socket G9 230V 40W temp.-resist. 300°C		

## timers

### programme timers

			
<b>GEV No.</b>	403577	<b>Ref. No.</b>	65090220 65095000 LAR65090220 LAR65095000
<b>description</b>	gear motor CDC 4901F1 engines 1 chambers 1 operation time 20s 230V 50Hz shaft ø 6x4.6mm shaft L 24mm		
<b>For models:</b>	ABE084S, ABE104S, ABE156X, ABG084X, ABG104X, AME07P, AREN064, AREN084, AREN154, ARES064, ARES084, ARES154, ARGN064, ARGN084, ARGN154, ARGS064, ARGS084, ARGS154, AVE07P, AVE10P, BPE064P, BPE074P, BPE084P, BPE104P, BPG064P, BPG074P, BPG084P, BPG104P, CKES10, EMT20P, EMT21P, EPE056T, EPE086T, EPE156T, EPEV05T, EPEV08T, EPEV15T, EPG056T, EPG086T, EPG156T, EPGV05T, EPGV08T, EPGV15T, EVEA20S, EVT06P, EVT10P, FEI102P, FME101AX, FME201SX, GEMT06P...(Other models you can see in the webshop)		

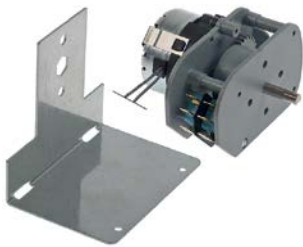
1

<b>GEV No.</b>	360633	<b>Ref. No.</b>	6A047080 BN6A047080
<b>description</b>	time switch kit 14000F3 operation time 120min impulse electric shaft ø 6x4.6mm shaft L 20mm CDC 230V engines 1 chambers 2		



1

<b>GEV No.</b>	362009	<b>Ref. No.</b>	65090060 A34100730 LA65090060 LAR65090060
<b>description</b>	timer CDC 11902F3 engines 1 chambers 2 operation time 108 230V 50/60Hz shaft ø 6x4.6mm shaft L 24mm manuf. no. 11902F3D-HE000.0000 motor type M48L for combi-steamer		



1

<b>GEV No.</b>	360709	<b>Ref. No.</b>	65090110 LA65090110 LAR65090110
<b>description</b>	timer CDC 14003F3 engines 1 chambers 3 operation time 120min shaft ø 6x4.6mm shaft L 22mm manuf. no. 14003F3120ME0.0010		
<b>For models:</b>	ICEM023, ICEM041, ICEM051, ICEM071, ICEM101, ICGM051, ICGM071, ICGM101, REC023M, REC051M, REC071M, REC101M, REP044M, REP054M, REP064M, REP074M, REP084M, REP104M, REV051M, REV071M, REV101M, RGC051M, RGC071M, RGC101M, RGP044M, RGP054M, RGP064M, RGP074M, RGP084M, RGP104M, RGV051M, RGV071M, RGV101M		



1

<b>GEV No.</b>	360752	<b>Ref. No.</b>	65090190 LA65090190 LAR65090190
<b>description</b>	timer CDC 4902F1 engines 1 chambers 2 operation time 8min 230V shaft ømm shaft Lmm		
<b>For models:</b>	A05PES, A05PES+UM, A05RES, A05RES+UM, A08PES, A08PES+UM, A08RES, A08RES+UM, A10PES, A10PES+UM, A10RES, A10RES+UM, ABE044M, ABE054M, ABG064M, ABG074M, ACE04M, ACE05M, ACE10M, ACG10M, APE06, APE07, APG08M, APG10M, BPE044M, BPE054M, BPE064M, BPE074M, BPE084M, BPE104M, BPG044M, BPG054M, BPG064M, BPG074M, BPG084M, BPG104M, CE041M, CE051M, CE071M, CE100M, CE106M, CE110M, CE200M, CE210M, CEC40M, CES24M, CES40M, CG051M, CG071M, CG100M...(Other models you can see in the webshop)		

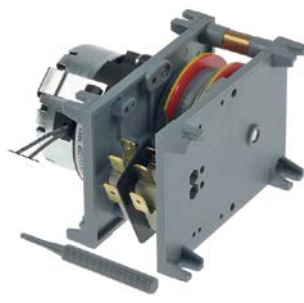

1

<b>GEV No.</b>	360720	<b>Ref. No.</b>	65090180 LAR65090180
<b>description</b>	timer CDC 4902V1 engines 1 chambers 2 operation time 8min 230V 50/60Hz manuf. no. 4902V110DEY000.0000		
<b>For models:</b>	ME110X, ME227M, ME227X, MG106M, MG106X, MG110M, MG110X, MG120M, MG120X, MG210M, MG210X, MG220M, MG220X, MG227M, MG227X, PE005M, PE008M, PE015M, PE088M, PE105M, PE108M, PE115M, PE188M, PG005M, PG008M, PG015M, PG088M, PG105M, PG108M, PG115M, PG188M		



1

<b>GEV No.</b>	360505	<b>Ref. No.</b>	65090050 LA65090050 LAR65090050	
<b>description</b>	timer FIBER P25 engines 1 chambers 3 operation time 108min 230V shaft ø 6x4.6mm shaft L 25mm motor type M51BJ0L6400 50/60			
<b>For models:</b>	PE005M, PE008M, PE015M, PE088M, PE105M, PE108M, PE115M, PE188M, PG005M, PG008M, PG015M, PG088M, PG105M, PG108M, PG115M, PG188M			
<b>spare parts for</b>	360505			
	<b>GEV No.</b>	360674	<b>Ref. No.</b>	—
	 motor kit pinion ø 6.8mm teeth 15 230V voltage AC 50/60Hz turn direction counterclockwise motor ø 48mm H 18.5mm motor type UDS40NE1RNZ165 cable length 150mm with holder			



1

<b>GEV No.</b>	350038	<b>Ref. No.</b>	50304580 65090020 LAR50304580 LAR65090020
<b>description</b>	timer FIBER P34 engines 1 chambers 2 operation time 144min 230V shaft ø 6x4.6mm shaft L 20mm manuf. no. P345J02N765 motor type M51BJL6400 impulse electric		
<b>For models:</b>	ABE044M, ABE054M, ABG064M, ABG074M, ACE04M, ACE05M, ACE10M, ACG10M, APE06, APE07, APG08M, APG10M, BPE044M, BPE054M, BPE064M, BPE074M, BPE084M, BPE104M, BPG044M, BPG054M, BPG064M, BPG074M, BPG084M, BPG104M, CE041M, CE051M, CE071M, CE100M, CE106M, CE110M, CE200M, CE210M, CEC40M, CES24M, CES40M, CG051M, CG071M, CG100M, CG106M, CG110M, CG200M, CG210M, CGC40M, CGS24M, CGS40M, ECO20M, EC106M, EC110M, EC210M, FE05...(Other models you can see in the webshop)		
<b>spare parts for</b>	350038		
	<b>GEV No.</b>	360674	<b>Ref. No.</b> —
	motor kit pinion ø 6.8mm teeth 15 230V voltage AC 50/60Hz turn direction counterclockwise motor ø 48mm H 18.5mm motor type UDS40NE1RNZ165 cable length 150mm with holder		

electric timers



1

<b>GEV No.</b>	350135	<b>Ref. No.</b>	65090090 LA65090090 LAR65090090
<b>description</b>	timer MS65 operation time 120min time spreadmin 1CO/2NO at 250V 16A permanent position yes time range 0-120min impulse electric shaft ø 6x4.6mm shaft L 21mm mounting distance 28mm connection male faston 6.3mm screw mounting 250V voltage AC 50Hz		
<b>For models:</b>	REC023M, REC051M, REC071M, REP044M, REP054M, REP064M, REP074M, REV051M, REV071M, REV101M, RGC101M		

with time spread



1

<b>GEV No.</b>	350074	<b>Ref. No.</b>	6032047
<b>description</b>	timer MS65 operation time 120min time spread 30min 1CO/2NO/1NC at 250V 16A permanent position yes impulse electric shaft ø 6x4.6mm shaft L 22mm mounting distance 28mm connection lateral Invensys 4-pole shaft position lower*		
<b>For models:</b>	VE102MX		



1

<b>GEV No.</b>	350148	<b>Ref. No.</b>	65090070 LAR65090070
<b>description</b>	timer MS65 operation time 120min time spread 30min 2NO at 250V 16A permanent position yes shaft ø 6x4.6mm shaft 6x4.6mm shaft L 20mm 2-pole		
<b>For models:</b>	A05PES, A05PES+UM, A05RES, A05RES+UM, A08PES, A08PES+UM, A08RES, A08RES+UM, A10PES, A10PES+UM, A10RES, A10RES+UM		

alarm devices

alarm units



1

<b>GEV No.</b>	350056	<b>Ref. No.</b>	65330050
<b>description</b>	alarm device 220-240VAC ømm H 25mm wall-mounted version mounting distancemm 83dB protection IPx0		

buzzer boards



1

<b>GEV No.</b>	400143	<b>Ref. No.</b>	65300670 LAR65300670
<b>description</b>	buzzer board		
<b>For models:</b>	ME106P, ME110P, ME120P, ME210P, ME220P, ME227P, MG106P, MG110P, MG120P, MG210P, MG220P, MG227P, PE105T, PE108T, PE115T, PE188T, PG105T, PG108T, PG115T, PG188T, VE106P, VE110P, VE120P, VE210P, VE220P, VG106P, VG110P, VG120P, VG210P, VG220P		

buzzers

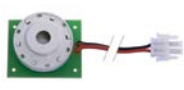



1

<b>GEV No.</b>	350055	<b>Ref. No.</b>	65330040 LA65330040 LAR65330040
<b>description</b>	buzzer 12VDC connection cable 200mm PCB buzzer 20dB		
<b>For models:</b>	CVE004H, CVE104H, CVE105H, CVG105H, FEI102P, FME101AX, FME201SX, FMG201A, FMG201S, LA10, LA15, LA16, LA18, LV10, LV15, LV16, LV18, ME106D, ME106H, ME106L, ME106P, ME106S, ME106T, ME110D, ME110H, ME110L, ME110P, ME110S, ME110T, ME120D, ME120H, ME120L, ME120P, ME120S, ME120T, ME210D, ME210H, ME210L, ME210P, ME210S, ME210T, ME220D, ME220H, ME220L, ME220P, ME220S, ME220T, ME227P, MEC20H, MEC20P...(Other models you can see in the webshop)		



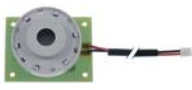

			
<b>GEV No.</b>	350086	<b>Ref. No.</b>	65301440 65321440 LA65301440 LAR65301440 LAR65321440 RA919008
<b>description</b>	buzzer 12VDC connection cable 200mm PCB buzzer 20dB		
<b>For models:</b>	AME07D, AME07P, AME10D, AVE07D, AVE07P, AVE10D, AVE10P, AVG05P, AVG10D, AVG20D, BPE044P, BPE054P, BPE064P, BPE074P, BPE084P, BPE104P, BPG044P, BPG054P, BPG064P, BPG074P, BPG084P, BPG104P, DP018T, DP112T, DPC20T, DPC40T, DX018T, DX110T, DX112T, DXC20T, DXC40T, EMT06D, EMT10D, EMT20P, EMT21P, EPE056T, EPE086T, EPE156T, EPEV05T, EPEV08T, EPEV15T, EPG056T, EPG086T, EPG156T, EPGV05T, EPGV08T, EPGV15T, EVT06D, EVT06P, EVT10P...(Other models you can see in the webshop)		

			
<b>GEV No.</b>	350223	<b>Ref. No.</b>	65301960 LA65302450 LAR65302450 R65301960
<b>description</b>	buzzer 12VDC connection coded PCB buzzer 20dB		
<b>For models:</b>	ABE084S, ABE104S, ABG084X, ABG104X, ABG156S, ARES064, ARES084, ARES154, ARG064, ARG084, ARG154, CBES061, CEV026S, CEV061S, CEV101S, CKES10, CME061S, COES026, COES061, COES101, CVE024S, CVE061S, CVES061, CVG061S, CVGS061, EVEA20S, GEMT07S, GEMT07X, GEMT10S, GEMT10X, GEMT20S, GEMT20X, GEMT21S, GEMT21X, GEMT40S, GEMT40X, GEVT06S, GEVT07S, GEVT07X, GEVT10S, GEVT10X, GEVT20S, GEVT20X, GEVT21S, GEVT21X, GEVT40S, GEVT40X, GGMT07S, GGMT07X, GGMT10S...(Other models you can see in the webshop)		

			
<b>GEV No.</b>	350050	<b>Ref. No.</b>	50304460 65330010 A34100750 LA65330010 LAR50304460 LAR65330010
<b>description</b>	buzzer 230VAC connection male faston 6.3mm screw mounting thread M4 60dB		
<b>For models:</b>	ABE044M, ABE054M, ACE04M, ACE05M, ACE10M, ACG10M, APE06, APE07, APG08M, APG10M, CE041M, CE051M, CE071M, CE100M, CE106M, CE110M, CE200M, CE210M, CEC40M, CES24M, CES40M, CG051M, CG071M, CG100M, CG105M, CG106M, CG110M, CG200M, CG210M, CGC24M, CGC40M, CGS24M, CGS40M, CVE004M, CVE104M, CVE105M, CVG105M, EC020M, EC106M, EC110M, EC210M, EM006M+SC, EM010M+SC, EM020M, EM106M, EM106M+SC, EM110M, EM110M+SC, EM210M, EM210M+SC...(Other models you can see in the webshop)		

			
<b>GEV No.</b>	350080	<b>Ref. No.</b>	6010103
<b>description</b>	buzzer buzzer		
<b>For models:</b>	VE102MX		

## contactors

### GENERAL ELECTRIC (AEG)

#### power contactors

			
<b>GEV No.</b>	380261	<b>Ref. No.</b>	187400
<b>description</b>	power contactor resistive load 32A 230VAC (AC3/400V) 17A/7.5kW main contacts 3NO auxiliary contacts 1NO connection screw connection type AEG LS7K 10A type GE CL02A 310		

### ISKRA (FANAL)

#### power contactors

			
<b>GEV No.</b>	380204	<b>Ref. No.</b>	6046038
<b>description</b>	power contactor resistive load 25A 230VAC (AC3/400V) 9A/4kW main contacts 3NO auxiliary contacts 1NO connection screw connection type Fanal DSL9 10 type ISKRA KNL9 10		
<b>For models:</b>	VE102MX		



## MOELLER/EATON

## power contactors



1

<b>GEV No.</b>	380550	<b>Ref. No.</b>	65140550 65140700 LAR65140700 LAR65140550 LAR65140700
<b>description</b>	power contactor resistive load 20A 230VAC (AC3/400V) 9A/4kW main contacts 3NO auxiliary contacts 1NC connection screw connection type DILM9 01		
<b>For models:</b>	ABE044M, ABE054M, ABE084S, ABE104S, ABG064M, ABG074M, ABG084X, ABG104X, ACE04M, ACE05M, ACE10M, ACG10M, AME07D, AME07P, AME10D, APE06, APE07, APG08M, APG10M, AVE07D, AVE07P, AVE10D, AVE10P, AVG10D, AVG20D, BPE044M, BPE044P, BPE054M, BPE054P, BPE064M, BPE064P, BPE074M, BPE074P, BPE084M, BPE084P, BPE104M, BPE104P, BPG064M, BPG064P, BPG074M, BPG074P, BPG084M, BPG084P, BPG104M, BPG104P, CBEN061, CBES061, CE041M, CE051M, CE071M...(Other models you can see in the webshop)		
<b>accessories for</b>	380550		
	<b>GEV No.</b>	380555	<b>Ref. No.</b> —
	auxiliary contact contacts 2NO/2NC AC15 16A for contactors DILEM connection screw type DILA-XHI22		
	<b>GEV No.</b>	380556	<b>Ref. No.</b> —
	auxiliary contact contacts 4NO AC15 16A for contactors DILM 7-32 connection screw type DILA-XHI40		
	<b>GEV No.</b>	380557	<b>Ref. No.</b> —
	auxiliary contact contacts 4NC AC15 16A for contactors DILM 7-32 connection screw type DILA-XHI04		
	<b>GEV No.</b>	380558	<b>Ref. No.</b> —
	auxiliary contact contacts 3NO/1NC AC15 16A for contactors DILM 7-32 connection screw type DILA-XHI31		
	<b>GEV No.</b>	380559	<b>Ref. No.</b> —
	auxiliary contact contacts 1NO/3NC AC15 16A for contactors DILM 7-32 connection screw type DILA-XHI13		
	<b>GEV No.</b>	380568	<b>Ref. No.</b> —
	RC circuit suitable for DILM 9-12 rated 110-240V		



1

<b>GEV No.</b>	381005	<b>Ref. No.</b>	65140560 65140710 LAR65140710 LAR65140560 LAR65140710
<b>description</b>	power contactor resistive load 35A 230VAC (AC3/400V) 17A/7.5kW main contacts 3NO auxiliary contacts 1NC connection screw connection type DILM 17-01		
<b>For models:</b>	ABE084S, ABE104S, ACE10M, AME10D, AVE10D, AVE10P, BPE084M, BPE084P, BPE104M, BPE104P, CE100M, CE200M, CEV101S, CEV101X, CKES10, COEN026, COEN061, COEN101, COES061, COES101, CVEN061, EMT10D, EPE086T, EPEV08T, EVEA20S, EVT10P, GEMT10P, GEMT10T, GEVT10P, GEVT10T, MACE10M, MACE20M, MCE101M, MCE102M, MEMT10D, MEMT10P, MEVT10D, MEVT10P, MME101P, MME102P, MVE101M, MVE101P, MVE102P, PE084M, PE084P, PE104M, PE104P, PEV08T, SCE101M, SME101S...(Other models you can see in the webshop)		

## overload switches



1

<b>GEV No.</b>	381006	<b>Ref. No.</b>	65160420 65160760 LAR65160420 LAR65160760
<b>description</b>	overload switch connection screw setting range 1-1.6A type ZB12		
<b>For models:</b>	ABE084S, ABE104S, ACE10M, AME10D, AVE10D, AVE10P, BPE084M, BPE084P, BPE104M, BPE104P, CE100M, CE200M, CKES10, EMT10D, EVEA20S, GEMT10P, GEVT10P, MACE10M, MACE20M, MCE101M, MCE102M, MEMT10D, MEVT10D, MME101P, MME102P, MVE101M, MVE101P, MVE102P, PE084M, PE084P, PE104M, PE104P, PEV08T, SCE101M, SME101S, SVE101S, SVEA20S		



auxiliary contacts



<b>GEV No.</b>	381007	<b>Ref. No.</b>	65140730 LA65140730 LAR65140730
<b>description</b>	auxiliary contact contacts 1NO/1NC AC15 10A for contactors connection screw type DILA-XHI11		
<b>For models:</b>	BPE064M, BPE064P, BPE074M, BPE074P, CBEN061, CBES061, CEV026S, CEV026X, CEV061S, CEV061X, CME061S, CME061X, COEN026, COEN061, COES026, COES061, CVE061S, CVE061X, CVEN061, CVES061, EPE086T, EPEV08T, EPG056T, EPG086T, EPGV05T, EPGV08T, GEMT06P, GEMT06T, GEMT10P, GEMT10T, GEVT06P, GEVT06S, GEVT06T, KME061S, KME061X, KVE061S, KVE061X, MME071P, MME101P, MVE071M, MVE071P, SIE071P, SME071S, SME101S, SVE071P, SVE071S		



<b>GEV No.</b>	380645	<b>Ref. No.</b>	50304271 65140230 65140240 LAR50304271 LAR65140230 LAR65140240
<b>description</b>	power contactor 230VAC with auxiliary contacts		
<b>For models:</b>	CE110M, CE210M, CEC40M, CES24M, CES40M, EC020M, EC110M, EC210M, EM010H, EM010M+SC, EM020M, EM110H, EM110M, EM110M+SC, EM110P, EM210H, EM210M, EM210M+SC, EM210P, EV010H, EV010M, EV010P, EV020M, EV110H, EV110M, EV110M+SC, EV110P, EV210H, EV210M, EV210M+SC, EV210P, FE110M, FE110X, FE1102P, FME101AX, FME201SX, FV06, LA15, LV15, ME110D, ME110H, ME110M, ME110P, ME110X, ME120D, ME120H, ME120L, ME120M, ME120P, ME120S...(Other models you can see in the webshop)		



<b>GEV No.</b>	380565	<b>Ref. No.</b>	65140600 65140740 LA65140740 LAR65140600 LAR65140740
<b>description</b>	auxiliary contact contacts 1NO/1NC AC15 10A for contactors DIL 17-32 connection screw type DILM 32-CHI11-S		
<b>For models:</b>	ABE084S, ABE104S, AME10D, AVE10P, BPE084P, BPE104P, CEV101S, CEV101X, CKES10, COEN026, COEN061, COEN101, COES061, COES101, CVEN061, EMT10D, EPE086T, EPEV08T, EVEA20S, EVT10P, GEVT10P, GEVT10T, MEMT10D, MEMT10P, MEVT10D, MEVT10P, MME101P, MME102P, MVE101M, MVE101P, MVE102P, PE084M, PE084P, PE104M, PE104P, PEV08T, SME101S, SVE101S, SVEA20S		



<b>GEV No.</b>	380652	<b>Ref. No.</b>	65140380 LA65140380 LAR65140380
<b>description</b>	power contactor resistive load 22A 230VAC (AC3/400V) 9A/4kW main contacts 3NO auxiliary contacts 1NC connection screw connection type 3RT10-16-1AP02		
<b>For models:</b>	ABE156X, ABG156S, AREN064, AREN154, ARES064, ARES084, ARES154, ARGN064, ARGN084, ARGN154, ARGV064, ARGV084, ARGV154, EMT20P, EMT21P, EPG156T, EPGV15T, EVT20D, GEMT07S, GEMT07X, GEMT10S, GEMT10X, GEMT20P, GEMT20S, GEMT21P, GEMT21S, GEMT21X, GEMT40P, GEMT40S, GEMT40X, GEVT07S, GEVT07X, GEVT10S, GEVT20P, GEVT20S, GEVT21P, GEVT21S, GEVT21X, GEVT40P, GEVT40S, GEVT40X, GGMT07S, GGMT07X, GGMT10S, GGMT10X, GGMT20P, GGMT20S, GGMT20T, GGMT20X, GGMT21P...(Other models you can see in the webshop)		

SIEMENS

power contactors



<b>GEV No.</b>	380644	<b>Ref. No.</b>	50304251 65140140 LAR50304251 LAR65140140
<b>description</b>	power contactor 230VAC auxiliary contacts 1NO/1NC		
<b>For models:</b>	FE05, FV03, ME05, ME10, ME110X, ME120P, ME15, ME20, ME21, ME227M, ME227P, ME227X, ME24, ME40, MG05, MG10, MG106M, MG106P, MG106X, MG110M, MG110P, MG110X, MG120M, MG120P, MG120X, MG15, MG20, MG21, MG210M, MG210P, MG210X, MG220M, MG220P, MG220X, MG227M, MG227P, MG227X, MG24, MG40, MME05, MME10, MME40, PE04, PE08, PE12, PG04, PG08, PG12, RE05, RE07...(Other models you can see in the webshop)		



<b>GEV No.</b>	380389	<b>Ref. No.</b>	A34100880
<b>description</b>	power contactor resistive load 22A 230VAC (AC3/400V) 9A/4kW main contacts 3NO auxiliary contacts 1NO connection screw connection type 3RT10-16-1AP01		
<b>For models:</b>	RC162M		



1

<b>GEV No.</b>	380646	<b>Ref. No.</b>	65140400 LA65140400 LAR65140400
<b>description</b>	power contactor resistive load 40A 230VAC (AC3/400V) 17A/7.5kW main contacts 3NO auxiliary contacts connection screw connection type 3RT10-25-1AL20		
<b>For models:</b>	ABE156X, AREN084, AREN154, ARES084, ARES154, EMT20P, EMT21P, EPE156T, EPEV15T, EVT20D, GEMT10S, GEMT10X, GEMT20P, GEMT20S, GEMT20T, GEMT20X, GEMT21P, GEMT21S, GEMT21T, GEMT21X, GEMT40P, GEMT40S, GEMT40T, GEMT40X, GEVT10S, GEVT10X, GEVT20P, GEVT20S, GEVT20T, GEVT20X, GEVT21P, GEVT21S, GEVT21T, GEVT21X, GEVT40P, GEVT40S, GEVT40T, GEVT40X, GSE201N, HME101P, HME101S, HME101T, HME101X, HME102P, HME102S, HME102T, HME102X, HME201P, HME201S, HME201T...(Other models you can see in the webshop)		

auxiliary contacts



1

<b>GEV No.</b>	380653	<b>Ref. No.</b>	65140420 LA65140420 LAR65140420
<b>description</b>	auxiliary contact contacts 1NO/1NC AC15 3A for contactors 3RT101 connection screw connection type 3RH1911-1FA11		
<b>For models:</b>	AREN064, ARES064, GEMT07S, GEMT07X, GEMT10S, GEMT10X, GEVT07S, GEVT07X, GEVT10X, HME101P, HME101S, HME101T, HME101X, HVE061P, HVE061T, HVE061X, KME072S, KME072X, KME081S, KME081X, KME101S, KME101X, KVE081S, KVE081X, LBET101, ME061D, ME061M, ME061P, ME061T, ME101D, ME101M, ME101P, ME101T, NAE071, NAE071R, NAE072R, NAE101, NAE-B101R, NAE072, NAE071, NAE071R, REP044S, REP054S, REP064S, REP074S, REV051S, REV071S, SAE071, SAE072, SAE101...(Other models you can see in the webshop)		



1

<b>GEV No.</b>	380647	<b>Ref. No.</b>	65140430 LA65140430 LAR65140430
<b>description</b>	auxiliary contact contacts 1NO/1NC AC15 3A for contactors 3RT102 3 RT103 connection screw connection type 3RH1921-1EA11 resistive load 10A AC-12 10A		
<b>For models:</b>	ABE156X, AREN084, AREN154, ARES084, ARES154, EMT20P, EMT21P, EPE156T, EPEV15T, GEMT10S, GEMT10X, GEMT20P, GEMT20S, GEMT20T, GEMT20X, GEMT21P, GEMT21S, GEMT21T, GEMT21X, GEMT40P, GEMT40S, GEMT40T, GEMT40X, GEVT10S, GEVT10X, GEVT20P, GEVT20S, GEVT20T, GEVT20X, GEVT21P, GEVT21S, GEVT21T, GEVT21X, GEVT40P, GEVT40S, GEVT40T, GEVT40X, GGMT21S, GGMT21X, GSE201N, HME101P, HME101S, HME101T, HME101X, HME102P, HME102S, HME102T, HME102X, HME201P, HME201S...(Other models you can see in the webshop)		

overload switches



1

<b>GEV No.</b>	380655	<b>Ref. No.</b>	65160150 LAR65160150
<b>description</b>	overload switch setting range 0.25-0.4A		
<b>For models:</b>	CVE004H, CVE004M, CVE104H, CVE104M, ME004L, ME004S, ME104L, ME104S, VE004D, VE004H, VE004M, VE004S, VE004X, VE104D, VE104H, VE104M, VE104S, VE104X		



1

<b>GEV No.</b>	380656	<b>Ref. No.</b>	50304450 65160100 65160110 LAR50304450 LAR65160100 LAR65160110
<b>description</b>	overload switch setting range 0.63-1A		
<b>For models:</b>	CG105M, CVE105H, CVE105M, CVG105H, CVG105M, EM010H, EM110H, EM110P, EM210H, EM210P, EV010H, EV010P, EV110H, EV110P, EV210H, EV210P, FE102X, FE110X, FE210X, FE1102P, FME201SX, FME61A, FME61S, ME105L, ME105S, ME106D, ME106H, ME106L, ME106M, ME106P, ME106S, ME106T, ME106X, ME110H, ME110L, ME110P, ME110S, ME110T, ME110X, ME120H, ME120L, ME120P, ME120T, ME120X, ME210H, ME210P, ME210S, ME210T, ME210X, ME220H...(Other models you can see in the webshop)		





1

<b>GEV No.</b>	380659	<b>Ref. No.</b>	65160570 LA65160570 LAR65160570
<b>description</b>	overload switch setting range 0.7-1A connection screw type 3RU1116-0JB0 (AC3/400V) 0.25kW		
<b>For models:</b>	ARES084, ARES154, EMT20P, EMT21P, ME101P, ME101T, ME102P, ME102T, ME201P, ME201T, ME202P, ME202T, MEMT20P, MEMT21P, MEMT40P, MEVT20P, MEVT21P, MEVT40P, PE156T, VE101P, VE102P, VE201P, VE202P		





			
1			
<b>GEV No.</b>	380661	<b>Ref. No.</b>	65160620 LA65160620 LAR65160620
<b>description</b>	overload switch setting range 1.4-2.0A connection screw type 3RU1116-1BB0 (AC3/400V) 0.75kW		
<b>For models:</b>	ABG156S, AREN064, ARES084, ARES154, ARGN064, ARGS084, ARGS154, EMT20P, EMT21P, GEMT07X, GEMT10S, GEMT20S, GEMT21P, GEMT21S, GEMT40P, GEMT40S, GEVT07X, GEVT10S, GEVT20P, GEVT20S, GEVT21P, GEVT21S, GEVT40P, GEVT40S, GGMT07X, GGVT07X, GMT20P, HME201P, HME201S, HME202P, HME202S, HVE101P, HVE101S, HVE102P, HVE102S, HVE201P, HVE201S, HVE202P, KME072S, KME081X, KME101S, KME201S, KME202S, KMEA20S, KMG081X, KVE072S, KVE081X, KVE101S, KVE102S, KVE201S...(Other models you can see in the webshop)		

			
1			
<b>GEV No.</b>	381071	<b>Ref. No.</b>	65160600 LA65160600 R65160600
<b>description</b>	overload switch setting range 3.5-5A		
<b>For models:</b>	NAGB072, NAGB072R, NAGB101, NAGB102, NAGB102R, NAGB201R, NAGB202, NAGB202R, NAGV071, NAGV071R, NAGV072, NAGV072R, NAGV101, NAGV102, NAGV202R		

			
1			
<b>GEV No.</b>	380657	<b>Ref. No.</b>	65160120 LAR65160120
<b>description</b>	overload switch setting range 1.8-2.5A		
<b>For models:</b>	CE110M, CE210M, CEC40M, CES24M, CES40M, ECO20M, EC110M, EC210M, EM010H, EM010M+SC, EM020M, EM110H, EM110M, EM110M+SC, EM110P, EM210H, EM210M, EM210M+SC, EM210P, EV010H, EV010M, EV010P, EV020M, EV110H, EV110M, EV110M+SC, EV110P, EV210H, EV210M, EV210M+SC, EV210P, FE102M, FE102X, FE110M, FE110X, FE210M, FE210X, FEI102P, FG102X, FG110X, FG210X, FME101AX, FME201SX, FMG201S, GM020H, GM110H, GM110P, GM210H, GM210P, GV010H...(Other models you can see in the webshop)		

motor protection circuit breakers

			
1			
<b>GEV No.</b>	382000	<b>Ref. No.</b>	65160590 LA65160590 LAR65160590
<b>description</b>	motor protection circuit breaker type 3RU1116-1EBO setting range 2.8-4A (AC3/400V) 1.5kW		
<b>For models:</b>	ABG156S, ARGS084, ARGS154, GEMT20P, GGMT10S, GGMT20P, GGMT20S, GGMT21P, GGMT21S, GGMT40P, GGMT40S, GGVT10S, GGVT20P, GGVT20S, GGVT21P, GGVT21S, GGVT40P, GGVT40S, GMT20D, GMT20P, GVT20D, HME101P, HME101S, HME102P, HME102S, HMG101P, HMG102P, HMG201P, HMG202P, HVG101P, HVG102P, HVG201P, HVG202P, KMG072S, KMG101S, KMG102S, KMG201S, KMG202S, KMG201M, MCG201M, MCG202M, MG101D, MG101M, MG101P, MG101T, MG102P, MG102T, MG201D, MG201H, MG201M...(Other models you can see in the webshop)		

			
1			
<b>GEV No.</b>	381002	<b>Ref. No.</b>	65160580 LA65160580 LAR65160580
<b>description</b>	overload switch setting range 1.8-2.5A		
<b>For models:</b>	EMT20P, HME202P		



			
1			
<b>GEV No.</b>	380648	<b>Ref. No.</b>	50304170 65160010 LAR50304170 LAR65160010
<b>description</b>	motor protection circuit breaker type 3VU1300-1MF00 setting range 0.6-1A auxiliary contacts 1NO/1NC		
<b>For models:</b>	ME10, ME15, ME20, ME21, ME24, ME40, MG10, MG15, MG20, MG21, MG24, MG40, MME10, MME40, PE08, PE12, PG08, PG12, RE07, RE10, RE20, RE24, RG07, RG10, RG20, RG24, RG40		





			
1			
<b>GEV No.</b>	380651	<b>Ref. No.</b>	50304200 65160030 LAR50304200 LAR65160030
<b>description</b>	motor protection circuit breaker type 3VU1300-1MJ00 setting range 2.4-4A auxiliary contacts 1NO/1NC		
<b>For models:</b>	ME10, ME15, ME20, ME21, ME24, ME40, MG10, MG15, MG20, MG21, MG24, MG40, MME10, MME40, PE08, PE12, PG08, PG12, RE07, RE10, RE20, RE24, RG07, RG10, RG20, RG24, RG40		

			
1			
<b>GEV No.</b>	380650	<b>Ref. No.</b>	50304180 65160040 LAR50304180 LAR65160040
<b>description</b>	motor protection circuit breaker type 3VU1300-1MK00 setting range 4-6A auxiliary contacts 1NO/1NC		
<b>For models:</b>	MG10, MG15, MG21, MG24, MG40, MME10, MME40, PG08, PG12, RE07, RG07, RG10, RG20, RG24, RG40		

miscellaneous

			
1			
<b>GEV No.</b>	381158	<b>Ref. No.</b>	65160130 LAR65160130
<b>description</b>	overload switch kit		
<b>For models:</b>	CG110M, CG210M, CGC24M, CGC40M, CGS24M, CGS40M, FG102M, FG102X, FG110M, FG110X, FG210M, FG210X, FMG201A, FMG201S, GC010M, GC020M, GC110M, GC210M, GM020H, GM020M, GM110H, GM110M, GM110M+SC, GM110P, GM210H, GM210M, GM210M+SC, GM210P, GV010H, GV010M, GV020H, GV110H, GV110M, GV110M+SC, GV110P, GV210H, GV210M, GV210M+SC, GV210P, ME110X, ME120P, ME227M, ME227P, ME227X, MG110D, MG110H, MG110L, MG110M, MG110P, MG110S...(Other models you can see in the webshop)		
<b>spare parts for</b>	381158		
	<b>GEV No.</b>	380652	<b>Ref. No.</b> 65140380 LA65140380 LAR65140380 R65140380
power contactor resistive load 22A 230VAC (AC3/400V) 9A/4kW main contacts 3NO auxiliary contacts 1NC connection screw connection type 3RT10-16-1AP02			

<b>spare parts for</b>	381158		
	<b>GEV No.</b>	380660	<b>Ref. No.</b> —
base			
	<b>GEV No.</b>	381071	<b>Ref. No.</b> 65160600 LA65160600 R65160600
overload switch setting range 3.5-5A			

power contactors

			
1			
<b>GEV No.</b>	380654	<b>Ref. No.</b>	65140150 65140170 LAR65140150 LAR65140170
<b>description</b>	power contactor 230V with auxiliary contacts		
<b>For models:</b>	CE106M, CE110M, CE210M, CEC40M, CES24M, CES40M, CG105M, CG106M, CG110M, CG210M, CGC24M, CGC40M, CGS24M, CGS40M, CVE004H, CVE004M, CVE104H, CVE104M, CVE105H, CVE105M, CVG105H, CVG105M, EC020M, EC106M, EC110M, EC210M, EM006H, EM006M+SC, EM010H, EM010M+SC, EM020M, EM106H, EM106M, EM106M+SC, EM106P, EM110H, EM110M, EM110M+SC, EM110P, EM210H, EM210M, EM210M+SC, EM210P, EV006M, EV006P, EV010H, EV010M, EV010P, EV020M, EV106H...(Other models you can see in the webshop)		



relay sockets

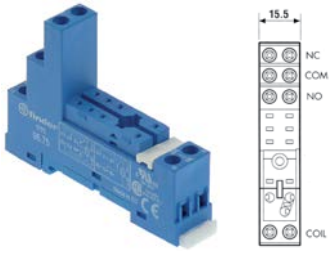

1

<b>GEV No.</b>	381181	<b>Ref. No.</b>	6040015
<b>description</b>	relay socket 2-pole 40.51/40.52/40.61 connection screw clamp dimensions 15.8x78.6mm 250V voltage AC 10A FINDER manuf. no. 95.75		
<b>For models:</b>	VE102MX		
<b>accessories for</b>	381181		
	<b>GEV No.</b>	381455	<b>Ref. No.</b> —
	support bracket		

level relays

**GICAR**



1

<b>GEV No.</b>	401173	<b>Ref. No.</b>	6041043
<b>description</b>	level relay 230V connection F6.3 type RL30/3ES/F		
<b>For models:</b>	VE102MX		

  

1

<b>GEV No.</b>	401224	<b>Ref. No.</b>	65120010 LAR65120010
<b>description</b>	level relay 230V connection F6.3 type RL30/3ES/F/G		
<b>For models:</b>	EM006M+SC, EM010M+SC, EM020M, EM106M, EM106M+SC, EM110M, EM110M+SC, EM210M, EM210M+SC, GM020M, GM106M, GM106M+SC, GM110M, GM110M+SC, GM210M, GM210M+SC, ME061M, ME101M, ME102D, ME102M, ME106M, ME106X, ME110M, ME110X, ME120M, ME120X, ME201M, ME202M, ME210M, ME210X, ME220M, ME220X, ME227M, ME227X, MEC20X, MEC40M, MES20M, MES20X, MES24M, MES24X, MES40M, MES40X, MG061M, MG101M, MG102M, MG106M, MG106X, MG110M, MG110X, MG120M...(Other models you can see in the webshop)		

time relays

time relays



1



<b>GEV No.</b>	381421	<b>Ref. No.</b>	65090450 LA65090450 LAR65090450
<b>description</b>	time relay CROUZET EMAR7 88 829 117 time range 0.1s-20h 240VAC 5A NO connection grip connection		
<b>For models:</b>	ACG10M, APG08M, APG10M, BPE064M, BPE074M, BPE084M, BPE104M, BPG064M, BPG074M, BPG084M, BPG104M, CG051M, CG071M, CG100M, CG105M, CG200M, CGC24M, CGC40M, CGS24M, CGS40M, CVG105H, CVG105M, MACG05M, MACG07M, MACG10M, MACG20M, MCG051M, MCG071M, MCG101M, MCG102M, ME061M, ME101M, ME102D, ME102M, ME106M, ME106X, ME110M, ME110X, ME201M, ME202M, ME210M, ME210X, MEC20X, MEC40M, MES20M, MES20X, MES24M, MES24X, MES40M, MES40X...(Other models you can see in the webshop)		

1

<b>GEV No.</b>	380489	<b>Ref. No.</b>	65090480 LA65090480 LAR65090480
<b>description</b>	time relay CROUZET MUR1-88826105 time range 0.1s-100h 24-240VAC/24VDC 8A mounting measurements DIN railmm 1CO connection grip connection		
<b>For models:</b>	AREN154, ARES154, ARGN154, ARGS154, EM006M+SC, EM010M+SC, EM020M, EM106M, EM106M+SC, EM110M, EM110M+SC, EM210M, EM210M+SC, GEMT21S, GEMT21X, GEMT40S, GEMT40X, GEVT21S, GEVT21X, GEVT40S, GEVT40X, GGMT21S, GGMT21X, GGMT40S, GGMT40X, GGVT21S, GGVT21X, GGVT40S, GGVT40X, GM020M, GM106M, GM106M+SC, GM110M, GM110M+SC, GM210M, GM210M+SC, LBES201, LBES202, LBET201, LBET202, LBGS201, LBGS202, LBGT201, LBGT202, LVES201, LVES202, LVET201, LVET202, LVGS201, LVGS202...(Other models you can see in the webshop)		



<b>GEV No.</b>	380329	<b>Ref. No.</b>	65090460 LAR65090460
<b>description</b>	time relay FIBER 85.02.8.240 time range 0.05s - 100h 230-240VAC 10A mounting measurements 20.6x27.7mm 2CO connection 2.0		
<b>For models:</b>	ME106M, ME106X, ME110M, ME110X, ME120M, ME120X, ME210M, ME210X, ME220M, ME220X, MG106M, MG106X, MG110M, MG110X, MG120M, MG120X, MG210M, MG210X, MG220M, MG220X, PE005M, PE008M, PE015M, PE088M, PE105M, PE108M, PE115M, PE188M, PG005M, PG008M, PG015M, PG088M, PG105M, PG108M, PG115M, PG188M		
<b>accessories for</b>	380329		
	<b>GEV No.</b>	380378	<b>Ref. No.</b> —
	relay socket 2-pole 55/85 dimensions 70.5x30x27mm 250V voltage AC 10A FINDER manuf. no. 94.72		
	<b>GEV No.</b>	380803	<b>Ref. No.</b> —
	relay socket 2-pole dimensions 76.2x27x86.1mm 250V voltage AC 10A FINDER manuf. no. 94.92.3		



<b>GEV No.</b>	381119	<b>Ref. No.</b>	6042049
<b>description</b>	time relay LOVATO TM D time range 0.06-180s		
<b>For models:</b>	VE102MX		



<b>GEV No.</b>	380607	<b>Ref. No.</b>	6042054
<b>description</b>	time relay LOVATO TM M1 time range 0s-10 days 12-24V AC/DC 8A 1CO connection grip connection		
<b>For models:</b>	VE102MX		

## transformers

### encapsulated transformers

#### with screw connection





<b>GEV No.</b>	400127	<b>Ref. No.</b>	65180430 LA65180430 LAR65180430
<b>description</b>	transformer primary 230VAC secondary 12VAC 40VA secondary 3.2A H 63mm L 75mm W 78mm connection 2-wire connection systems 50/60Hz moulded		
<b>For models:</b>	ABE156X, ABG156S, AREN064, AREN084, AREN154, ARES084, ARES154, ARGN064, ARGN084, ARGN154, ARGS084, ARGS154, CBEN061, CE110M, CE210M, CEC40M, CES24M, CES40M, CG110M, CG210M, CGC24M, CGC40M, CGS24M, CGS40M, CKES10, COEN026, COEN061, COEN101, CVEN061, CVGN061, ECO20M, EC110M, EC210M, EM010H, EM010M+SC, EM020M, EM110H, EM110M, EM110M+SC, EM110P, EM210H, EM210M, EM210M+SC, EM210P, EMT10D, EMT20P, EMT21P, EPE086T, EPE156T, EPEV08T...(Other models you can see in the webshop)		

#### PMA





<b>GEV No.</b>	401340	<b>Ref. No.</b>	65180770 LA65180770 LAR65180770
<b>description</b>	transformer primary 220/240V secondary 24V 50VA secondary 2.1A connection screw 50/60Hz		
<b>For models:</b>	ACG10M, APG08M, APG10M, AVG05P, AVG10D, AVG20D, CG051M, CG071M, CG100M, CG200M, GMT06D, GMT06P, GMT20D, GMT20P, GVT06D, GVT06P, GVT20D, MACG05M, MACG07M, MACG10M, MACG20M, MG061D, MG061H, MG061M, MG061P, MG061T, MG101D, MG101H, MG101M, MG101P, MG101T, MG102D, MG102H, MG102M, MG102P, MG102T, MG201D, MG201H, MG201M, MG201P, MG201T, MG202D, MG202H, MG202M, MG202P, MG202T, MGMT06D, MGMT06P, MGMT10D, MGMT10P...(Other models you can see in the webshop)		

			
<b>GEV No.</b>	401339	<b>Ref. No.</b>	65180370 LA65180370 LAR65180370
<b>description</b>	transformer primary 220/240V secondary 8/12V 6VA secondary 0.3/0.2A connection screw 50/60Hz		
<b>For models:</b>	FME61A, FME61S, FMG201A, FMG201S, ME004L, ME004S, ME104L, ME104S, ME105L, ME105S, ME106L, ME106S, ME110L, ME110S, ME120L, ME120S, ME210L, ME210S, ME220L, ME220S, MG105L, MG105S, MG106L, MG106S, MG110L, MG110S, MG120L, MG120S, MG210L, MG210S, MG220L, MG220S, VE004S, VE104S, VE105NS, VE105S, VE106L, VE106S, VE110L, VE110S, VE120L, VE120S, VE210L, VE210S, VG105S, VG106L, VG106S, VG110L, VG110S, VG210L...(Other models you can see in the webshop)		

			
<b>GEV No.</b>	400126	<b>Ref. No.</b>	65180420 960002 LA65180420 LAR65180420
<b>description</b>	transformer primary 230VAC secondary 12VAC 20VA secondary 2.1A connection screw 50Hz		
<b>For models:</b>	ABE084S, ABE104S, ABE156X, ABG064M, ABG074M, ABG084X, ABG104X, ABG156S, ACE10M, ACG10M, AME07D, AME07P, AME10D, APE06, APE07, APG08M, APG10M, AREN064, ARES064, ARES084, ARES154, ARGN064, ARGS064, ARGS084, ARGS154, AVE07D, AVE07P, AVE10D, AVE10P, AVG05P, AVG10D, AVG20D, BPE044M, BPE044P, BPE054M, BPE054P, BPE064M, BPE064P, BPE074M, BPE074P, BPE084M, BPE084P, BPE104M, BPE104P, BPG044M, BPG044P, BPG054M, BPG054P, BPG064M, BPG064P...(Other models you can see in the webshop)		

			
<b>GEV No.</b>	400125	<b>Ref. No.</b>	65180410 LA65180410 LAR65180410
<b>description</b>	transformer primary 220-240V secondary 12V 16VA secondary 12V/0.3A/1AA connection screw 50Hz		
<b>For models:</b>	EM106P, EM110P, EM210P, EV006P, EV106P, EV110P, EV210P, FEI102P, GM106P, GM110P, GM210P, GV106P, GV110P, GV210P, ME106P, ME106T, ME110P, ME110T, ME120P, ME120T, ME210P, ME210T, ME220P, ME220T, MEC20P, MEC40P, MES20P, MES24P, ME-S40P, MG106P, MG106T, MG110P, MG110T, MG120P, MG120T, MG210P, MG210T, MG220P, MG220T, MGC40P, MGS20P, MGS24P, MGS40P, PE005D, PE008D, PE015D, PE088D, PE105D, PE105T...(Other models you can see in the webshop)		

			
<b>GEV No.</b>	379054	<b>Ref. No.</b>	50305010 65180530 LAR50305010 LAR65180530
<b>description</b>	transformer primary 230VAC secondary 12VAC 3VA secondary 0.25A H 40mm L 45mm W 50mm connection screw 50/60Hz type 153/M		
<b>For models:</b>	ME004L, ME004S, ME104L, ME104S, ME105L, ME105S, ME106L, ME106S, ME110L, ME110S, ME120L, ME120S, ME210L, ME210S, ME220L, ME220S, MG105L, MG105S, MG106L, MG106S, MG110L, MG110S, MG120L, MG120S, MG210L, MG210S, MG220L, MG220S, MME05, MME10, MME40, RE05, RE07, RE10, RE20, RE24, RG05, RG10, RG20, RG24, RG40		

			
<b>GEV No.</b>	400096	<b>Ref. No.</b>	50305030 50305080 65180400 LA65180400 LAR50305030 LAR50305080 LAR65180400
<b>description</b>	transformer primary 230V secondary 12V 15VA connection screw 50Hz		
<b>For models:</b>	FV03, FV06, ME05, ME10, ME15, ME20, ME21, ME24, ME40, MG05, MG10, MG15, MG20, MG21, MG24, MG40, PE04		





## electronic controllers





### ELIWELL

#### universal controllers

##### built-in version



1

<b>GEV No.</b>	379605	<b>Ref. No.</b>	65340010
<b>description</b>	electronic controller ELIWELL type ICPPlus915 model ICP22JI35000 mounting measurements 71x29mm 12V voltage AC/DC Pt100/TC (J,K) relay outputs 2 NO-8A(4) NO-8A(4) Pt100/TC (J,K) cooking front measurements 78x37mm built-in depth 59mm mode of operation cooking protection IPx0 accuracy 1% built-in version defr. funct. no dependend on probe°C display 3½ digits		
<b>accessories for</b>	379605		
	<b>GEV No.</b>	379050	<b>Ref. No.</b> 65325010 LAR65325010 R65320160 R65325010
	temperature probe Pt100 cable Vetrotex probe -200 up to +600°C cable -50 up to +350°C probe ø6x100mm cable length 2.7m without screw connection 3-wire		
	<b>GEV No.</b>	379054	<b>Ref. No.</b> 50305010 65180530 LAR50305010 LAR65180530 R50305010 R65180530
	transformer primary 230VAC secondary 12VAC 3VA secondary 0.25A H 40mm L 45mm W 50mm connection screw 50/60Hz type 153/M		
	<b>GEV No.</b>	379785	<b>Ref. No.</b> —
	temperature probe Pt100 cable silicone probe -100 up to 450°C cable -50 up to +180°C probe ø6x100mm cable length 1.5m without screw connection 2-wire resistor 0.1kOhm		
	<b>GEV No.</b>	379786	<b>Ref. No.</b> —
	temperature probe Pt100 cable silicone probe -100 up to 450°C cable -50 up to +180°C probe ø6x100mm cable length 3m without screw connection 2-wire resistor 0.1kOhm		
	<b>GEV No.</b>	379787	<b>Ref. No.</b> —
	temperature probe Pt100 cable Vetrotex probe -200 up to +600°C cable -50 up to +350°C probe ø6x100mm cable length 1.4m without screw connection 2-wire resistor 0.1kOhm		

## SHANGFANG

#### accessories



1

<b>GEV No.</b>	379054	<b>Ref. No.</b>	50305010 65180530 LAR50305010 LAR65180530
<b>description</b>	transformer primary 230VAC secondary 12VAC 3VA secondary 0.25A H 40mm L 45mm W 50mm connection screw 50/60Hz type 153/M		
<b>For models:</b>	ME004L, ME004S, ME104L, ME104S, ME105L, ME105S, ME106L, ME106S, ME110L, ME110S, ME120L, ME120S, ME210L, ME210S, ME220L, ME220S, MG105L, MG105S, MG106L, MG106S, MG110L, MG110S, MG120L, MG120S, MG210L, MG210S, MG220L, MG220S, MME05, MME10, MME40, RE05, RE07, RE10, RE20, RE24, RG05, RG10, RG20, RG24, RG40		

## TECNOLOGIC

#### universal controllers

##### built-in version



1

<b>GEV No.</b>	379268	<b>Ref. No.</b>	50304860 LAR50304860 LAR65340010
<b>description</b>	electronic controller TECNOLOGIC type TLK38FCR mounting measurements 71x29mm Pt100		
<b>For models:</b>	ME05, ME10, ME15, ME20, ME21, ME24, ME40, MG05, MG10, MG15, MG20, MG21, MG24, MG40, MME10, MME40, RE05, RE07, RE10, RE20, RE24, RG05, RG10, RG20, RG24, RG40		

## probes

### universal probes

#### temperature probes



1

<b>GEV No.</b>	379860	<b>Ref. No.</b>	6000100
<b>description</b>	temperature probe NTC 10kOhm cable PVC probe -20 up to +80°C cable -10 up to 100°C probe ø6x40mm cable length 1.5m without screw connection 2-wire		
<b>For models:</b>	VE102MX		

<b>GEV No.</b>	379222 <sup>1</sup>	<b>Ref. No.</b>	6000083
<b>description</b>	temperature probe Pt100 cable Vetrotex probe -200 up to +600°C cable -50 up to +350°C probe ø4x110mm cable length 1.4m 3-wire		
<b>For models:</b>	VE102MX		

<sup>1</sup>3-wire



<b>GEV No.</b>	379130 <sup>1</sup>	<b>Ref. No.</b>	50305101 65325000 LAR50305101 LAR65325000
<b>description</b>	temperature probe Pt100 cable Vetrotex probe -200 up to +600°C cable -50 up to +350°C probe ø6x100mm cable length 1.4m without screw connection 3-wire resistance at 0°C 100Ohm		
<b>For models:</b>	AME07D, AME07P, AME10D, AVE07D, AVE07P, AVE10D, AVE10P, AVG05P, AVG10D, AVG20D, BPE044P, BPE054P, BPE064P, BPE074P, BPE084P, BPE104P, BPG044P, BPG054P, BPG064P, BPG074P, BPG084P, BPG104P, CVE004H, CVE104H, CVE105H, CVG105H, EM006H, EM010H, EM106H, EM106P, EM110H, EM110P, EM210H, EM210P, EMT06D, EMT10D, EMT20P, EMT21P, EPE056T, EPE086T, EPE156T, EPEV05T, EPEV08T, EPEV15T, EPG056T, EPG086T, EPG156T, EPGV05T, EPGV08T, EPGV15T...(Other models you can see in the webshop)		

<sup>1</sup>3-wire



<b>GEV No.</b>	379050 <sup>1</sup>	<b>Ref. No.</b>	65325010 LAR65325010 R65320160
<b>description</b>	temperature probe Pt100 cable Vetrotex probe -200 up to +600°C cable -50 up to +350°C probe ø6x100mm cable length 2.7m without screw connection 3-wire		
<b>For models:</b>	EMT21P, EPE156T, EPEV15T, EPG156T, EPGV15T, GEMT21P, GEMT21T, GEMT40P, GEMT40T, GEVT21P, GEVT21T, GEVT40P, GEVT40T, GGMT21P, GGMT21T, GGMT40P, GGMT40T, GGV21P, GGV21T, GGV21P, GGV21T, GGV21P, GGV21T, GSE201N, HME201P, HME201T, HME202P, HME202T, HMG201P, HMG201T, HMG202P, HMG202T, HVE201P, HVE201T, HVE202P, HVE202T, HVG201P, HVG201T, HVG202P, HVG202T, LA10, LA16, LV10, LV16, ME201D, ME202D, ME220D, ME220H, ME220P, ME220T, MEC24H, MEC40H...(Other models you can see in the webshop)		

<sup>1</sup>3-wire



<b>GEV No.</b>	379052	<b>Ref. No.</b>	995452 995453
<b>description</b>	temperature probe PTC 1kOhm cable silicone probe -50 up to +150°C cable -50 up to +180°C probe ø6x40mm cable length 1.5m without screw connection 2-wire		
<b>For models:</b>	ABM023S, ABM031S		





<b>GEV No.</b>	381363	<b>Ref. No.</b>	65320220 LAR65320220
<b>description</b>	temperature probe thermocouple K (NiCr-Ni) probe -50 up to 1150°C cable -50 up to +180°C cable length 1.5m thread M10x1 adapter length 93mm adapter ø 6mm cable colours silver/yellow probe L 90/14mm probe ø 6/3mm		
<b>For models:</b>	ABE084S, ABE104S, ABE156X, ABG084X, ABG104X, ABG156S, AREN064, AREN084, AREN154, ARES064, ARES084, ARES154, ARGN064, ARGN084, ARGN154, ARGS064, ARGS084, ARGS154, CBEN061, CBES061, CEV026S, CEV026X, CEV061S, CEV061X, CEV101S, CEV101X, CKES10, CME061S, CME061X, COEN026, COEN061, COEN101, COES026, COES061, COES101, CVE024S, CVE024X, CVE061S, CVE061X, CVEN061, CVES061, CVG061S, CVG061X, CVGN061, CVGS061, EVEA20S, GEMT07S, GEMT07X, GEMT10S, GEMT10X...(Other models you can see in the webshop)		

producer-specific probes

probes





<b>GEV No.</b>	379143	<b>Ref. No.</b>	50305111 65320150 65325020 KAR65LAR65320150 LAR50305111 LAR65325020	
<b>description</b>	temperature probe Pt100 cable Vetrotex probe -200 up to +600°C cable -50 up to +350°C connection 2-wire thread probe ø3-6x90mm cable length 5m			
<b>For models:</b>	ME20, ME220D, ME220H, ME220P, ME220T, MEC40H, MEC40P, MED40D, MES40D, MES40H, MES40P, MG20, MG220D, MG220H, MG220P, MG220T, MGC40H, MGC40P, MGS40D, MGS40H, MGS40P, PEV08T, VE220D, VE220H, VE220P, VES40D, VES40H, VES40P, VG220D, VG220H, VG220P, VGC24H, VGS24D, VGS24H, VGS40H, VGS40P			
<b>spare parts for</b>	379143			
	<b>GEV No.</b>	100909	<b>Ref. No.</b>	62060223 LA62060223 LAR62060223 R62060223
	union screw thread M10x1 for pipe ø 6mm Qty 1 pcs			
	<b>GEV No.</b>	101286	<b>Ref. No.</b>	62070023 LA62070023 LAR62070023 R62070023
	olive ID ø 6mm Qty 1 pcs			





<b>GEV No.</b>	379511	<b>Ref. No.</b>	65320250 65320270 A34100660 LAR65320270 LAR65320250 LAR65320270
<b>description</b>	temperature probe thermocouple J cable silicone probe -50 up to +750°C cable -50 up to +180°C connection 2-wire thread probe ø3x150mm cable length 3m		
<b>For models:</b>	LA10, LA15, LA16, LA18, LV10, LV15, LV16, LV18, PE105D, PE105K, PE105T, PE108D, PE108K, PE108T, PE115D, PE115K, PE115T, PE188D, PE188K, PE188T, PG105D, PG105K, PG105T, PG108D, PG108K, PG108T, PG115D, PG115K, PG115T, PG188D, PG188K, PG188T		





1 			
<b>GEV No.</b>	381463	<b>Ref. No.</b>	65320230 LAR65320230
<b>description</b>	temperature probe thermocouple K (NiCr-Ni) cable glass fibre thread M9x1 probe 6x80 cable length 3m		
<b>For models:</b>	HME201S, HME201X, HME202S, HME202X, HMG201X, HMG202X, HVE201S, HVE201X, HVE202X, HVG201X, HVG202X		

core probes			
1 			
<b>GEV No.</b>	379134	<b>Ref. No.</b>	65320900 LA65320900 LAR65320900
<b>description</b>	core temperature probe Pt100 cable PTFE probe -40 up to +250°C cable -40 up to +250°C connection plug probe ø4x100mm thread cable length 1m handle ø 15mm handle length 83mm		
<b>For models:</b>	CVE004H, CVE104H, CVE105H, CVG105H, EM006H, EM006M+SC, EM010H, EM010M+SC, EM106H, EM106M+SC, EM106P, EM110H, EM110M+SC, EM110P, EM210H, EM210M+SC, EM210P, EV006P, EV010H, EV010P, EV020M, EV106H, EV106M+SC, EV106P, EV110H, EV110M+SC, EV110P, EV210H, EV210M+SC, EV210P, FEI102P, FME201SX, GM020H, GM106H, GM106M+SC, GM106P, GM110H, GM110M+SC, GM110P, GM210H, GM210M+SC, GM210P, GV006H, GV006M, GV010H, GV020H, GV106H, GV106M+SC, GV106P, GV110H...(Other models you can see in the webshop)		

1 			
<b>GEV No.</b>	379135	<b>Ref. No.</b>	65320690 65320700 65320730 65320740 65320770 65320780 65320810 65320820 65320850 65320860 65325200 65325210 65325220 65325230 65325240 65325250 65325800 LAR65320690 LAR65320700 LAR65320730 LAR65320740 LAR65320770 LAR65320780 LAR65320810 LAR65320820 LAR65320850 LAR65320860 LAR65325200 LAR65325210 LAR65325220 LAR65325230 LAR65325240 LAR65325250 LAR65325800
<b>description</b>	core temperature probe Pt100 cable PTFE probe -40 up to +250°C cable -40 up to +250°C connection plug probe ø4x100mm thread cable length 1m handle ø 15mm handle length 83mm		
<b>For models:</b>	FME61S, FMG201S, ME004L, ME104L, ME105L, ME105S, ME106L, ME106T, ME110L, ME110T, ME120L, ME120S, ME120T, ME210L, ME210T, ME220L, ME220S, ME220T, MG105L, MG105S, MG106L, MG106T, MG110L, MG110T, MG120L, MG120T, MG210L, MG210T, MG220L, MG220T, VE004S, VE104S, VE105NS, VE105S, VE106L, VE106T, VE110L, VE110T, VE120L, VE210L, VE210T, VG105S, VG106L, VG106T, VG110L, VG110S, VG110T, VG210L, VG210S, VG210T		

1 			
<b>GEV No.</b>	379132	<b>Ref. No.</b>	50305121 65320180 LAR50305121 LAR65320180
<b>description</b>	core temperature probe Pt100 cable SS corrugated hose probe -40 up to +250°C cable -40 up to +250°C connection 2-wire probe ø4x100mm thread 1/8" cable length 2.5m handle ø 9mm handle length 85mm		
<b>For models:</b>	ME05, ME10, ME20, ME24, MG05, MG10, MG20, MG24, MME05, MME10, RE05, RE07, RE20, RE24, RG05, RG20, RG24		

			
<b>GEV No.</b>	379510	<b>Ref. No.</b>	65321100 65321102 LA65321102 LAR65321100 LAR65321102
<b>description</b>	core temperature probe thermocouple K (NiCr-Ni) cable PTFE probe -40 up to +250°C cable -40 up to +250°C connection 6-pin connector probe ø3.5x90mm thread cable length 1.1m handle ømm handle length 90mm		
<b>For models:</b>	ABE156X, ABG084X, ABG104X, AREN064, AREN084, AREN154, ARES064, ARES084, ARES154, ARGN064, ARGN084, ARGN154, ARGS064, ARGS084, ARGS154, CBEN061, CBES061, CEV026S, CEV026X, CEV061S, CEV061X, CEV101S, CEV101X, CME061S, CME061X, COEN026, COEN061, COEN101, COES026, COES061, COES101, CVE024S, CVE024X, CVE061S, CVE061X, CVEN061, CVES061, CVG061S, CVG061X, CVGN061, CVGS061, GEMT06T, GEMT07S, GEMT07X, GEMT10S, GEMT10T, GEMT10X, GEMT20S, GEMT20T, GEMT20X...(Other models you can see in the webshop)		

			
<b>GEV No.</b>	379773	<b>Ref. No.</b>	65321120 LA65321122 LAR65321120
<b>description</b>	core temperature probe thermocouple K (NiCr-Ni) cable PTFE probe -40 up to +250°C cable -40 up to +250°C connection plug probe ø3.5x90mm thread cable length 1.1m handle ømm handle length 90mm		
<b>For models:</b>	ABE084S, ABE104S, ABG156S, AME07D, AME07P, AME10D, AVE07D, AVE07P, AVE10D, AVE10P, AVG05P, AVG10D, AVG20D, EMT06D, EMT10D, EMT20P, EMT21P, EVEA20S, EVT06D, EVT06P, EVT10P, EVT20D, GEMT06P, GEMT10P, GEMT20P, GEMT21P, GEMT40P, GEVT06P, GEVT06S, GEVT10P, GEVT20P, GEVT21P, GEVT40P, GGMT06P, GG-MT10P, GGMT20P, GGMT21P, GGMT40P, GGVT06P, GGVT10P, GGVT20P, GGVT21P, GGVT40P, GMT06D, GMT06P, GMT20D, GMT20P, GVT06D, GVT06P, GVT20D...(Other models you can see in the webshop)		

\*multipoint probe

accessories

plugs/bushes

			
<b>GEV No.</b>	378016	<b>Ref. No.</b>	65320920 LA65320920 LAR65320920
<b>description</b>	female connector 4-pole		
<b>For models:</b>	ABE084S, ABE104S, ABG156S, AME07D, AME07P, AME10D, AVE07D, AVE07P, AVE10D, AVE10P, AVG05P, AVG10D, AVG20D, CVE004H, CVE104H, CVE105H, CVG105H, EM006H, EM006M+SC, EM010H, EM010M+SC, EM106H, EM106M+SC, EM106P, EM110H, EM110M+SC, EM110P, EM210H, EM210M+SC, EM210P, EMT06D, EMT10D, EMT20P, EMT21P, EV006P, EV010H, EV010P, EV020M, EV106H, EV106M+SC, EV106P, EV110H, EV110M+SC, EV110P, EV210H, EV210M+SC, EV210P, EVEA20S, EVT06D, EVT06P...(Other models you can see in the webshop)		

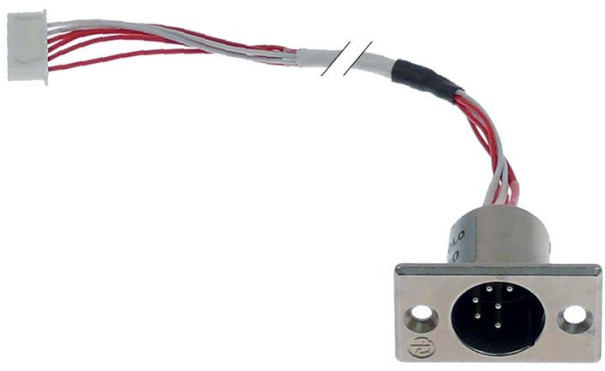
			
<b>GEV No.</b>	381462	<b>Ref. No.</b>	65321360 LA65321360 R65321360
<b>description</b>	female connector with cable 6-pole for combi-steamer L 1000mm		
<b>For models:</b>	AREN064, AREN084, AREN154, ARES064, ARES084, ARES154, ARGN064, ARGN084, ARGN154, ARGS064, ARGS084, ARGS154, CBEN061, CVEN061, CVGN061, LBES071, LBES072, LBES101, LBES102, LBES201, LBES202, LBET071, LBET072, LBET101, LBET102, LBET201, LBET202, LBGS071, LBGS072, LBGS101, LBGS102, LBGS201, LBGS202, LBGT071, LBGT072, LBGT101, LBGT102, LBGT201, LBGT202, LVES071, LVES072, LVES101, LVES102, LVES201, LVES202, LVET071, LVET072, LVET101, LVET102, LVET201...(Other models you can see in the webshop)		

			
<b>GEV No.</b>	378017	<b>Ref. No.</b>	65321020 LA65321020 LAR65321020
<b>description</b>	lid for plug contact		
<b>For models:</b>	ABE084S, ABE104S, ABE156X, ABG084X, ABG104X, ABG156S, AME07D, AME07P, AME10D, AVE07D, AVE07P, AVE10D, AVE10P, AVG05P, AVG10D, AVG20D, CEV026S, CEV026X, CEV061S, CEV061X, CEV101S, CEV101X, CKES10, CME061S, CME061X, CVE004H, CVE024S, CVE024X, CVE061S, CVE061X, CVE104H, CVE105H, CVG061S, CVG061X, CVG105H, EM006H, EM006M+SC, EM010H, EM010M+SC, EM106H, EM106M+SC, EM106P, EM110H, EM110M+SC, EM110P, EM210H, EM210M+SC, EM210P, EMT06D, EMT10D...(Other models you can see in the webshop)		



miscellaneous

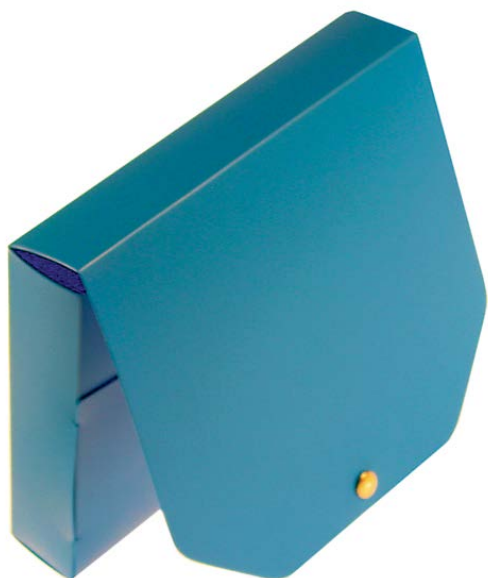

1

<b>GEV No.</b>	379856	<b>Ref. No.</b>	86020420 LAR86020420
<b>description</b>	bag for core temperature probe		
<b>For models:</b>	ABE084S, ABE104S, ABE156X, ABG084X, ABG104X, ABG156S, AME07D, AME07P, AME10D, AVE07D, AVE07P, AVE10D, AVE10P, AVG10D, AVG20D, CVE004H, CVE104H, CVE105H, CVG105H, EM006H, EM006M+SC, EM010H, EM010M+SC, EM106H, EM106M+SC, EM106P, EM110H, EM110M+SC, EM110P, EM210H, EM210M+SC, EM210P, EMT06D, EMT10D, EMT20P, EMT21P, EV006P, EV010H, EV010P, EV020M, EV106H, EV106M+SC, EV106P, EV110H, EV110M+SC, EV110P, EV210H, EV210M+SC, EV210P, EVEA20S...(Other models you can see in the webshop)		

PCBs



1

<b>GEV No.</b>	400192	<b>Ref. No.</b>	65300990 LAR65300990
<b>description</b>	calibrator		

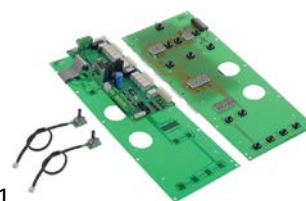

1

<b>GEV No.</b>	403472	<b>Ref. No.</b>	65301400 LAR65301400
<b>description</b>	control PCB combi-steamer VE 061/1011 L 410mm W 150mm suitable for LAINOX		
<b>For models:</b>	AVE07P, AVE10P, EVT06P, EVT10P, GVT06P, MEVT06P, MEVT10P, MEVT20P, MEVT21P, MEVT40P, MGVT06P, MGVT10P, MGVT20P, MGVT21P, MGVT40P, PE064P, PE074P, PE084P, PE104P, VE061P, VE101P, VE102P, VE201P, VE202P, VG061P, VG101P, VG102P, VG201P, VG202P		

electronics

frequency converters



1

<b>GEV No.</b>	403841	<b>Ref. No.</b>	65140830 65140890 LA65140890 LAR65140830 LAR65140890
<b>description</b>	frequency converter with heat sink for combi-steamer L 135mm W 135mm 800W ECS P0010205-0		
<b>For models:</b>	ABE156X, ABG084X, ABG104X, AREN064, AREN084, AREN154, ARGN064, ARGN084, ARGN154, EPE056T, EPE086T, EPE156T, EPEV05T, EPEV08T, EPEV15T, EPG056T, EPG086T, EPG156T, EPGV05T, EPGV08T, EPGV15T, GEMT07X, GEMT10T, GEMT10X, GEMT20T, GEMT20X, GEMT21T, GEMT21X, GEMT40T, GEMT40X, GEVT07X, GEVT10T, GEVT10X, GEVT20T, GEVT20X, GEVT21T, GEVT21X, GEVT40T, GEVT40X, GGMT07X, GGMT10T, GGMT10X, GGMT20T, GGMT20X, GGMT21T, GGMT40T, GGMT40X, GGVT07X, GGVT10T, GGVT10X...(Other models you can see in the webshop)		

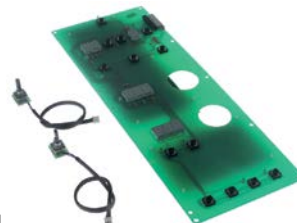

1

<b>GEV No.</b>	402427	<b>Ref. No.</b>	65301370 65301390 LA65301390 LAR65301370 LAR65301390
<b>description</b>	control PCB L 410mm W 150mm for LAINOX buttons 13		
<b>For models:</b>	AME07P, AVE07P, AVE10P, EMT20P, EMT21P, EVT06P, EVT10P, GMT06P, GMT20P, GVT06P, ME061H, ME061P, ME101H, ME101P, ME102H, ME102P, ME201H, ME201P, ME202H, ME202P, MEMT06P, MEMT10P, MEMT20P, MEMT21P, MEMT40P, MEVT06P, MEVT10P, MEVT20P, MEVT21P, MEVT40P, MG061H, MG061P, MG101H, MG101P, MG102H, MG102P, MG201H, MG201P, MG202H, MG202P, MGMT06P, MGMT10P, MGMT20P, MGMT21P, MGMT40P, MGVT06P, MGVT10P, MGVT20P, MGVT21P, MGVT40P...(Other models you can see in the webshop)		



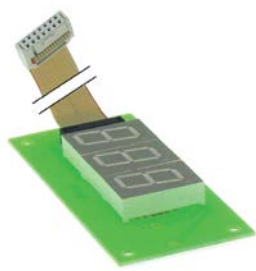

1

<b>GEV No.</b>	401166	<b>Ref. No.</b>	6010095
<b>description</b>	display		
<b>For models:</b>	VE102MX		





1

<b>GEV No.</b>	400149	<b>Ref. No.</b>	65300580 LAR65300580
<b>description</b>	keypad PCB		
<b>For models:</b>	VE004X, VE104X, VE105X, VE155X, VG105X		



1

<b>GEV No.</b>	401591	<b>Ref. No.</b>	65301410 65301420 65301460 LAR65301410 LAR65301420 LAR65301460
<b>description</b>	keypad PCB combi-steamer ME061T complete		
<b>For models:</b>	ME061T, ME101T, ME102T, ME201T, ME202T, MG061T, MG101T, MG102T, MG201T, MG202T		
<b>spare parts for</b>	401591		
	<b>GEV No.</b>	350086	<b>Ref. No.</b> 65301440 65321440 LA65301440 LAR65301440 LAR65321440 R65301440 R65321440 RA919008
	buzzer 12VDC connection cable 200mm PCB buzzer 20dB		
	<b>GEV No.</b>	401338	<b>Ref. No.</b> 65301450 65321450 LAR65301450 LAR65321450 R65301450 R65321450
	encoder		



1

<b>GEV No.</b>	400140	<b>Ref. No.</b>	65300500 LAR65300500
<b>description</b>	keypad PCB combi-steamer ME106M with keypad		
<b>For models:</b>	ME106M, ME110M, ME120M, ME210M, MG106M, MG110M, MG120M, MG210M, MG220M, VE106M, VE110M, VE120M, VE210M, VE220M, VG106M, VG110M, VG120M, VG210M, VG220M		



1

<b>GEV No.</b>	401661	<b>Ref. No.</b>	65301800 65301810 65301820 65301830 LAR65301800 LAR65301810 LAR65301820 LAR65301830
<b>description</b>	keypad PCB combi-steamer MVE04 kit		
<b>For models:</b>	AVG05P, BPE044P, BPE054P, BPG044P, BPG054P, MVE042P, MVE051P, MVG051P, VE042P, VE051P, VE055P, VG051P		

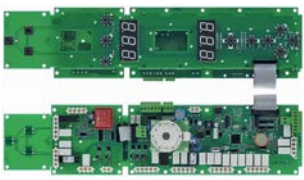

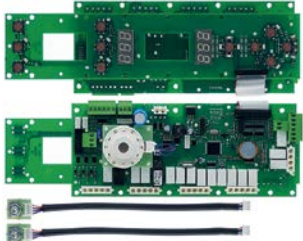

1

<b>GEV No.</b>	403821	<b>Ref. No.</b>	65302110 LAR65302110
<b>description</b>	keypad PCB for combi-steamer		
<b>For models:</b>	GEMT07S, GEMT10S, GEMT20S, GEMT21S, GEMT40S, GGMT07S, GGMT10S, GGMT20S, GGMT21S, GGMT40S, HME101S, HME102S, HME201S, HME202S, KME072S, KME081S, KME101S, KME201S, KME202S, KMEA20S, KMG072S, KMG081S, KMG101S, KMG102S, KM-G201S, KMG202S, KMGA20S, LBES071, LBES072, LBES101, LBES102, LBES201, LBES202, LBGS071, LBGS072, LBGS101, LBGS102, LBGS201, LBGS202, SAEB071, SAEB072, SAEB101, SAEB102, SAEB201, SAEB202, SAGB071, SAGB072, SAGB101, SAGB102, SAGB201...(Other models you can see in the webshop)		

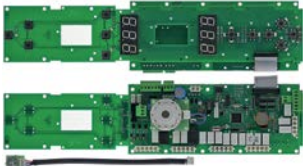
			
1			
<b>GEV No.</b>	403830	<b>Ref. No.</b>	65302220 LA65302220 R65302220
<b>description</b>	keypad PCB for combi-steamer L 325mm W 103mm		
<b>For models:</b>	CBES061, CME061S, CVE061S, CVES061, CVG061S, CVGS061, KME061S, KVE061S		

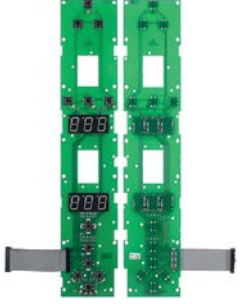
			
1			
<b>GEV No.</b>	403829	<b>Ref. No.</b>	65302100 LAR65302100
<b>description</b>	keypad PCB for combi-steamer L 437mm W 103mm		
<b>For models:</b>	ARE064, ARE084, ARES154, ARGS064, ARGS084, ARGS154, CKES10, EVEA20S, GEVT06S, GEVT07S, GEVT10S, GEVT20S, GEVT21S, GEVT40S, GGV07S, GGV10S, GGV20S, GGV21S, GGV40S, HVE101S, HVE102S, HVE201S, KVE072S, KVE081S, KVE101S, KVE102S, KVE201S, KVE202S, KVEA20S, KVG081S, LVES071, LVES072, LVES101, LVES102, LVES201, LVES202, LVGS071, LVGS072, LVGS101, LVGS102, LVGS201, LVGS202, SAEV071, SAEV072, SAEV101, SAEV102, SAEV201, SAEV202, SAGV071, SAGV072...(Other models you can see in the webshop)		

			
1			
<b>GEV No.</b>	403823	<b>Ref. No.</b>	65302240 LA65302240 LAR65302240
<b>description</b>	keypad PCB for combi-steamer L 443mm W 83mm		
<b>For models:</b>	ABE084S, ABE104S, ABG156S, ARES064, ARES084, ARES154, ARGS064, ARGS084, ARGS154, CKES10, EVEA20S, GEMT07S, GEMT10S, GEMT20S, GEMT21S, GEMT40S, GEVT06S, GEVT07S, GEVT10S, GEVT20S, GEVT21S, GEVT40S, GGMT07S, GGMT10S, GGMT20S, GGMT21S, GGMT40S, GGV07S, GGV10S, GGV20S, GGV21S, GGV40S, HME101S, HME102S, HME201S, HME202S, HVE101S, HVE102S, HVE201S, KME072S, KME081S, KME101S, KME201S, KME202S, KMEA20S, KMG072S, KMG081S, KMG101S, KMG102S, KMG201S...(Other models you can see in the webshop)		

			
1			
<b>GEV No.</b>	403831	<b>Ref. No.</b>	65300400 65300510 65300560 LA65300400 LAR65300400 LAR65300510 LAR65300560
<b>description</b>	keypad PCB for combi-steamer L 95mm W 80mm		
<b>For models:</b>	ME227M, MG106M, MG110M, MG120M, MG210M, MG220M, MG227M, PE005M, PE008M, PE015M, PE088M, PE105M, PE108M, PE115M, PE188M, PG005M, PG008M, PG015M, PG088M, PG105M, PG108M, PG115M, PG188M		

			
1			
<b>GEV No.</b>	400142	<b>Ref. No.</b>	65300370 65300570 LAR65300370 LAR65300570
<b>description</b>	keypad PCB L 100mm W 95mm buttons 8		
<b>For models:</b>	ME106X, ME110X, ME120X, ME210X, ME220M, ME220X, MG106X, MG110X, MG120X, MG210X, MG220X, VE106X, VE110X, VE120X, VE210X, VE220X, VG106X, VG110X, VG120X, VG210X, VG220X		

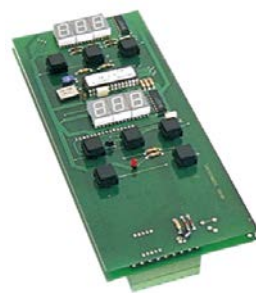
			
1			
<b>GEV No.</b>	400154	<b>Ref. No.</b>	50304890 65300070 LAR50304890 LAR65300070
<b>description</b>	keypad PCB L 217mm W 112mm with display		
<b>For models:</b>	FV03, FV06		



1

<b>GEV No.</b>	400150	<b>Ref. No.</b>	65300830 LAR65300830
<b>description</b>	main PCB		
<b>For models:</b>	CVE004H, CVE104H, CVE105H, CVG105H, VE004D, VE004H, VE104D, VE104H, VE105D, VE105H, VE155H, VG105D, VG105H		



1

<b>GEV No.</b>	403209	<b>Ref. No.</b>	65302280 LA65302280 LAR65302280
<b>description</b>	main PCB combi-steamer REV051/077/1015 L 250mm W 105mm LAINOX		
<b>For models:</b>	CBES061, CEV026S, CEV061S, CEV101S, CME061S, COES026, COES061, COES101, CVE024S, CVE061S, CVE061S, CVG061S, CVGS061, KME061S, KVE061S, REP044S, REP054S, REP064S, REP074S, REP084S, REP104S, REV051S, REV071S, REV101S, RGP044S, RGP054S, RGP064S, RGP074S, RGP084S, RGP104S, RGV051S, RGV071S, RGV101S, SVE042S, SVE051S		

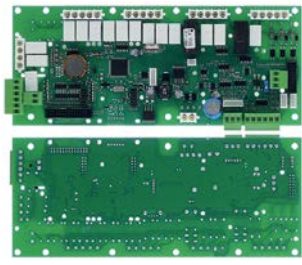

1

<b>GEV No.</b>	403824	<b>Ref. No.</b>	65302250 LA65302250 LAR65302250
<b>description</b>	main PCB for combi-steamer L 250mm W 103mm		
<b>For models:</b>	ABE084S, ABE104S, ABG156S, ARES064, ARES084, ARES154, ARGS064, ARGS084, ARGS154, CKES10, EVEA20S, GEMT07S, GEMT10S, GEMT20S, GEMT21S, GEMT40S, GEVT06S, GEVT07S, GEVT10S, GEVT20S, GEVT21S, GEVT40S, GGMT07S, GGMT10S, GGMT20S, GGMT21S, GGMT40S, GGVT07S, GGVT10S, GGVT20S, GGVT21S, GGVT40S, HME101S, HME102S, HME201S, HME202S, HVE101S, HVE102S, HVE201S, KME072S, KME081S, KME101S, KME201S, KME202S, KMEA20S, KMG072S, KMG081S, KMG101S, KMG102S, KMG201S...(Other models you can see in the webshop)		

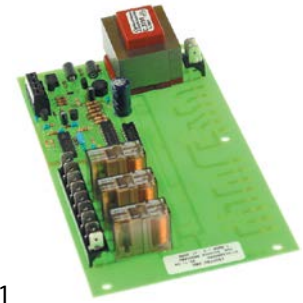

1

<b>GEV No.</b>	401333	<b>Ref. No.</b>	65300490 LA65300490 LAR65300490
<b>description</b>	PCB		
<b>For models:</b>	EM006M+SC, EM010M+SC, EM106M+SC, EM110M+SC, EM210M+SC, EV020M, EV106M+SC, EV110M+SC, EV210M+SC, GM106M+SC, GM110M+SC, GM210M+SC, GV006M, GV106M+SC, GV110M+SC, GV210M+SC, ME061M, ME101M, ME102M, ME106X, ME110X, ME201M, ME202M, ME210X, MEC20X, MES20X, MES24X, MES40X, MG061M, MG101M, MG102M, MG106X, MG110X, MG201M, MG202M, MG210X, MGC20X, MGC40X, MGS20X, MGS24X, MGS40X, MVE071M, MVE101M, VE061M, VE101M, VE102M, VE106X, VE110X, VE201M, VE202M...(Other models you can see in the webshop)		



1

<b>GEV No.</b>	401341	<b>Ref. No.</b>	63130020 63130021 LA63130021 LAR63130020 LAR63130021
<b>description</b>	PCB		
<b>For models:</b>	ACG10M, APG08M, APG10M, AVG05P, AVG10D, AVG20D, CG051M, CG071M, CG100M, CG200M, GMT06D, GMT06P, GMT20D, GMT20P, GVT06D, GVT06P, GVT20D, MACG05M, MACG07M, MACG10M, MACG20M, MG061D, MG061H, MG061M, MG061P, MG061T, MG101D, MG101H, MG101M, MG101P, MG101T, MG102D, MG102H, MG102M, MG102P, MG102T, MG201D, MG201H, MG201M, MG201P, MG201T, MG202D, MG202H, MG202M, MG202P, MG202T, MGMT06D, MGMT06P, MGMT10D, MGMT10P...(Other models you can see in the webshop)		

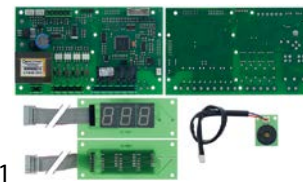



1

<b>GEV No.</b>	401195	<b>Ref. No.</b>	3103245
<b>description</b>	PCB combi-steamer CV10E complete without potentiometer		





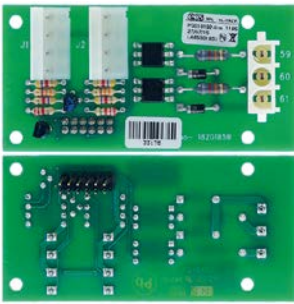

			
1			
<b>GEV No.</b>	401167	<b>Ref. No.</b>	6010096
<b>description</b>	PCB combi-steamer VE 06/10 230V 50/60Hz		
<b>For models:</b>	VE102MX		
<b>accessories for</b>	401167		
	<b>GEV No.</b>	<b>Ref. No.</b>	—
	 buzzer board 230VAC L 48mm W 45mm connection Faston 6.3mm		

			
1			
<b>GEV No.</b>	400152	<b>Ref. No.</b>	65300850 LAR65300850
<b>description</b>	PCB core temperature		
<b>For models:</b>	CVE004H, CVE104H, CVE105H, CVG105H, VE004H, VE104H, VE105H, VE155H, VG105H		

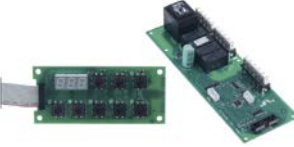
			
1			
<b>GEV No.</b>	403828	<b>Ref. No.</b>	65301950 LA65301950 LAR65301950
<b>description</b>	PCB for combi-steamer L 85mm W 42mm		
<b>For models:</b>	ABG084X, ABG104X, ABG156S, ARGS064, ARGS084, ARGS154, CME061X, CVG061S, CVG061X, CVGS061, GGMT07S, GGMT07X, GGMT10S, GGMT10X, GGMT20S, GGMT20X, GGMT21S, GGMT21X, GGMT40S, GGMT40X, GGVT07S, GGVT07X, GGVT10S, GGVT10X, GGVT20S, GGVT20X, GGVT21S, GGVT21X, GGVT40S, GGVT40X, HMG061X, HMG101X, HMG102X, HMG201X, HMG202X, HVG061X, HVG101X, HVG102X, HVG201X, HVG202X, ICGT051, ICGT071, ICGT101, KME061X, KMG072S, KMG072X, KMG081S, KMG081X, KM-G101S, KMG101X...(Other models you can see in the webshop)		

			
1			
<b>GEV No.</b>	402923	<b>Ref. No.</b>	65300750 65300751 LAR65300750 LAR65300751
<b>description</b>	PCB for display PCB		
<b>For models:</b>	LA10, LA15, LA16, LA18, LV10, LV15, LV16, LV18		

			
1			
<b>GEV No.</b>	402922	<b>Ref. No.</b>	65301280 LAR65301280
<b>description</b>	PCB L 175mm W 83mm		

			
1			
<b>GEV No.</b>	402973	<b>Ref. No.</b>	63130050 LA63130050 LAR63130050
<b>description</b>	PCB oven BPG044-104 L 140mm W 80mm for cooler control		
<b>For models:</b>	ABG064M, ABG074M, BPG044M, BPG044P, BPG054M, BPG054P, BPG064M, BPG064P, BPG074M, BPG074P, BPG084M, BPG084P, BPG104M, BPG104P, EPG056T, EPG086T, EPG156T, EPGV05T, EPGV08T, EPGV15T, GGMT06P, GGMT06T, GGMT10P, GGMT10T, GGMT20P, GGMT20T, GGMT21P, GGMT21T, GGMT40P, GGMT40T, GGVT06P, GGVT06T, GGVT10P, GGVT10T, GGVT20P, GGVT20T, GGVT21P, GGVT21T, GGVT40P, GGVT40T, HMG061P, HMG061T, HMG101P, HMG101T, HMG102P, HMG102T, HMG102X, HMG201P, HMG201T, HMG202P...(Other models you can see in the webshop)		

			
1			
<b>GEV No.</b>	400194	<b>Ref. No.</b>	65300150 LAR65300150
<b>description</b>	reset PCB		
<b>For models:</b>	MG105L, MG105S, MG106L, MG106T, MG110L, MG110S, MG110T, MG120L, MG120S, MG120T, MG210L, MG210S, MG210T, MG220L, MG220S, MG220T		

## keypads

			
1			
<b>GEV No.</b>	401294	<b>Ref. No.</b>	67010100 LAR67010100
<b>description</b>	front foil		
<b>For models:</b>	MG105S, VE105S, VG105S		





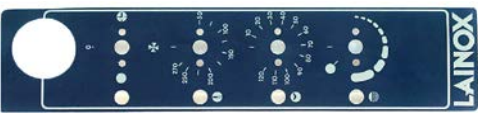

			
<b>GEV No.</b>	401295	<b>Ref. No.</b>	67010110 LAR67010110
<b>description</b>	front foil		
<b>For models:</b>	ME105L, MG105L, VE105S, VG105S		

			
<b>GEV No.</b>	401296	<b>Ref. No.</b>	50708710 67010010 LAR50708710 LAR67010010
<b>description</b>	front foil		
<b>For models:</b>	PE08, PE12, PG04, PG08, PG12, RE05, RE07, RE10, RE20, RE24, RG05, RG07, RG10, RG20, RG24, RG40		

			
<b>GEV No.</b>	401302	<b>Ref. No.</b>	67010230 LAR67010230
<b>description</b>	front foil		
<b>For models:</b>	VE106S, VE110S, VE120S, VE210S, VG106S, VG110S, VG210S		

			
<b>GEV No.</b>	401303	<b>Ref. No.</b>	67010240 LAR67010240
<b>description</b>	front foil		
<b>For models:</b>	VE106L, VE110L, VE110S, VE120L, VE210L, VG106L, VG110L, VG210L		

			
<b>GEV No.</b>	401304	<b>Ref. No.</b>	67010450 LAR67010450
<b>description</b>	front foil		
<b>For models:</b>	CVE004M, CVE104M, VE004M, VE104M		

			
<b>GEV No.</b>	401308	<b>Ref. No.</b>	67010530 LAR67010530
<b>description</b>	front foil		
<b>For models:</b>	VE106M, VE110M, VE120M, VE210M, VE220M, VG106M, VG110M, VG120M, VG210M, VG220M		

			
<b>GEV No.</b>	401313	<b>Ref. No.</b>	67012950 LAR67012950
<b>description</b>	front foil		
<b>For models:</b>	ME061M, ME101M, ME102M, ME201M, ME202M, MG061M, MG101M, MG102M, MG201M, MG202M, VE061M, VE101M, VE102M, VE201M, VE202M, VG061M, VG101M, VG102M, VG201M, VG202M		

			
<b>GEV No.</b>	401315	<b>Ref. No.</b>	50708430 67012040 LAR50708430 LAR67012040
<b>description</b>	front foil		
<b>For models:</b>	ME05, ME10, ME15, ME20, ME21, ME24, ME40, MG05, MG10, MG15, MG20, MG21, MG24, MG40		

			
<b>GEV No.</b>	401316	<b>Ref. No.</b>	50708460 67012050 LAR50708460 LAR67012050
<b>description</b>	front foil		
<b>For models:</b>	ME10, ME15, ME20, ME21, ME24, ME40		

			
<b>GEV No.</b>	401297	<b>Ref. No.</b>	67010080 LAR67010080
<b>description</b>	front foil blue suitable for LAINOX L 400mm W 75mm		
<b>For models:</b>	ME004S, ME104S, VE004S, VE104S		



<b>GEV No.</b>	511930	<b>Ref. No.</b>	67012200 LAR67012200
<b>description</b>	front foil blue suitable for LAINOX L 430mm W 95mm		
<b>For models:</b>	CE106M, CE110M, CE210M, CEC40M, CES24M, CES40M, CG106M, CG110M, CG210M, CGC40M, CGS24M, CGS40M		

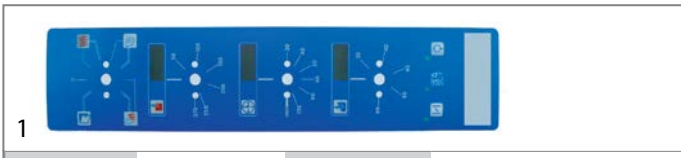

<b>GEV No.</b>	401301	<b>Ref. No.</b>	67010031 LAR67010031
<b>description</b>	front foil blue suitable for LAINOX L 435mm W 102mm		
<b>For models:</b>	ME106L, ME110L, ME110S, ME120L, ME120S, ME210L, ME220L, MG106L, MG110L, MG120L, MG210L, MG220L		



<b>GEV No.</b>	401959	<b>Ref. No.</b>	67450510 LAR67450510
<b>description</b>	front foil combi-steamer MVE042P		
<b>For models:</b>	ACE05M, AVG05P, MVE042P		

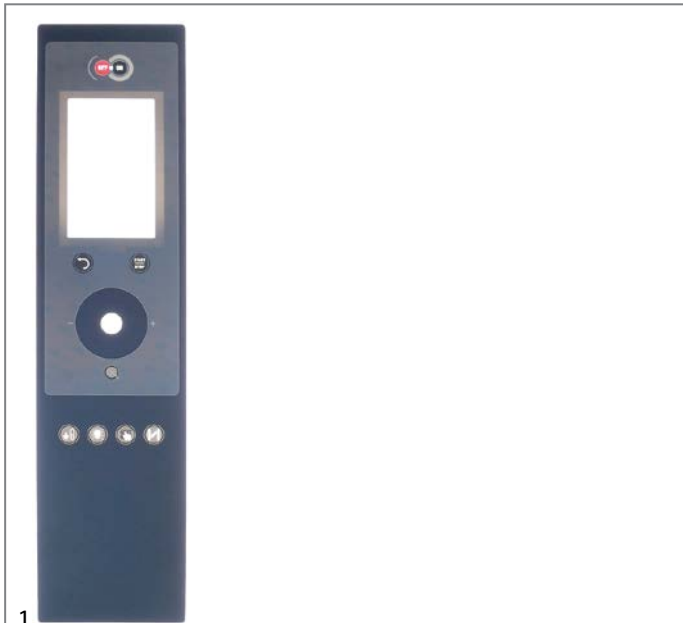

<b>GEV No.</b>	403820	<b>Ref. No.</b>	67013900 LA67013940 LAR67013900
<b>description</b>	front foil for combi-steamer L 660mm W 160mm		
<b>For models:</b>	HME061X, HME101X, HME102X, HME201X, HME202X, HMG061X, HMG101X, HMG102X, HMG201X, HMG202X, HVE061X, HVE101X, HVE102X, HVE201X, HVE202X, HVG061X, HVG101X, HVG102X, HVG201X, HVG202X		



<b>GEV No.</b>	401305	<b>Ref. No.</b>	67010460 LAR67010460
<b>description</b>	front foil suitable for LAINOX L 399mm W 74mm		
<b>For models:</b>	VE004X, VE104X		



<b>GEV No.</b>	401306	<b>Ref. No.</b>	67010490 LAR67010490
<b>description</b>	front foil suitable for LAINOX L 493mm W 75mm		
<b>For models:</b>	CG105M, CVE105M, CVG105M, VE105M, VE155M, VG105M		





<b>GEV No.</b>	401293	<b>Ref. No.</b>	67010830 LAR67010830
<b>description</b>	keypad foil		
<b>For models:</b>	MG105L, MG105S, MG106L, MG106S, MG106T, MG110L, MG110S, MG110T, MG120L, MG120S, MG120T, MG210L, MG210S, MG210T, MG220L, MG220S, MG220T		



			
<b>GEV No.</b>	401307	<b>Ref. No.</b>	67010500 LAR67010500
<b>description</b>	keypad foil		
<b>For models:</b>	VE105X, VE155X, VG105X		

			
<b>GEV No.</b>	401309	<b>Ref. No.</b>	67010550 LAR67010550
<b>description</b>	keypad foil		
<b>For models:</b>	VE106X, VE110X, VE120X, VE210X, VE220X, VG106X, VG110X, VG120X, VG210X, VG220X		

			
<b>GEV No.</b>	401311	<b>Ref. No.</b>	67010630 LAR67010630
<b>description</b>	keypad foil		
<b>For models:</b>	ME106X, ME110X, ME120X, ME210X, ME220X, MG106X, MG110X, MG120X, MG210X, MG220X		

			
<b>GEV No.</b>	401312	<b>Ref. No.</b>	67012960 LAR67012960
<b>description</b>	keypad foil		
<b>For models:</b>	ME061M, ME101M, ME102M, ME201M, ME202M, MG061M, MG101M, MG102M, MG201M, MG202M, VE061M, VE101M, VE102M, VE201M, VE202M, VG061M, VG101M, VG102M, VG201M, VG202M		

			
<b>GEV No.</b>	401317	<b>Ref. No.</b>	50708100 67010730 LAR50708100 LAR67010730
<b>description</b>	keypad foil		
<b>For models:</b>	FV03, FV06		

			
<b>GEV No.</b>	401320	<b>Ref. No.</b>	67010780 LAR67010780
<b>description</b>	keypad foil		
<b>For models:</b>	ME106T, ME110T, ME120T, ME210T, ME220T, MG106T, MG110T, MG120T, MG210T, MG220T		

			
<b>GEV No.</b>	401321	<b>Ref. No.</b>	67010900 LAR67010900
<b>description</b>	keypad foil		
<b>For models:</b>	VE106T, VE110T, VE210T, VG106T, VG210T		

			
<b>GEV No.</b>	401322	<b>Ref. No.</b>	67010650 LAR67010650
<b>description</b>	keypad foil		
<b>For models:</b>	ME106D, ME110D, ME120D, ME210D, ME220D, MG106D, MG110D, MG120D, MG210D, MG220D		

			
<b>GEV No.</b>	401323	<b>Ref. No.</b>	67010930 LAR67010930
<b>description</b>	keypad foil		
<b>For models:</b>	VE106D, VE110D, VE120D, VE210D, VE220D, VG106D, VG110D, VG120D, VG210D, VG220D		

			
<b>GEV No.</b>	401325	<b>Ref. No.</b>	67010940 LAR67010940
<b>description</b>	keypad foil		
<b>For models:</b>	VE106H, VE110H, VE120H, VE210H, VE220H, VES20H, VES24H, VES40H, VG106H, VG110H, VG120H, VG210H, VG220H, VGC20H, VGC24H, VGS20H, VGS24H, VGS40H		

			
<b>GEV No.</b>	401326	<b>Ref. No.</b>	67010920 LAR67010920
<b>description</b>	keypad foil		
<b>For models:</b>	ME106P, ME110P, ME120P, ME210P, ME220P, MEC20P, MEC40P, MES20P, MES24P, MES40P, MG106P, MG110P, MG120P, MG210P, MG220P, MGC40P, MGS20P, MGS24P, MGS40P		

			
<b>GEV No.</b>	401327	<b>Ref. No.</b>	67010950 LAR67010950
<b>description</b>	keypad foil		
<b>For models:</b>	VE106P, VE110P, VE120P, VE210P, VE220P, VEC20P, VES20P, VES24P, VES40P, VG106P, VG110P, VG120P, VG210P, VG220P, VGS20P, VGS40P		





<b>GEV No.</b>	401329	<b>Ref. No.</b>	67010870 LAR67010870
<b>description</b>	keypad foil		
<b>For models:</b>	CVE004H, CVE104H, VE004H, VE104H		



<b>GEV No.</b>	401330	<b>Ref. No.</b>	67012910 LAR67012910
<b>description</b>	keypad foil		
<b>For models:</b>	ME061H, ME101H, ME102H, ME201H, ME202H, MG061H, MG101H, MG101P, MG102H, MG201H, MG202H		



<b>GEV No.</b>	401349	<b>Ref. No.</b>	67013461 LA67013461 LAR67013461
<b>description</b>	keypad foil		
<b>For models:</b>	VE042P, VE051P, VE055P, VG051P		



<b>GEV No.</b>	511931	<b>Ref. No.</b>	67901230 LAR67901230
<b>description</b>	keypad foil blue L 270mm W 90mm		



<b>GEV No.</b>	511932	<b>Ref. No.</b>	67901250 LAR67901250
<b>description</b>	keypad foil blue L 270mm W 90mm		



<b>GEV No.</b>	401328	<b>Ref. No.</b>	67010850 LAR67010850
<b>description</b>	keypad foil blue L 400mm W 75mm buttons 7		
<b>For models:</b>	VE004D, VE104D		



<b>GEV No.</b>	511933	<b>Ref. No.</b>	67010770 LAR67010770
<b>description</b>	keypad foil L 430mm W 95mm buttons 17		

membrane keypads



<b>GEV No.</b>	403673	<b>Ref. No.</b>	67016870 67016871 LA67016870 LA67016871 LAR67016870 LAR67016871
<b>description</b>	keypad foil combi-steamer NABOO suitable for LAINOX		
<b>For models:</b>	AREN064, AREN084, ARGN064, ARGN084, NAEB071, NAEB071R, NAEB072R, NAEB101, NAEB101R, NAEB102, NAEB102R, NAEB072, NAEV071, NAEV071R, NAEV072, NAEV072R, NAEV101, NAEV101R, NAEV102, NAEV102R, NAGB071, NAGB071R, NAGB072, NAGB072R, NAGB101, NAGB101R, NAGB102, NAGB102R, NAGV071, NAGV071R, NAGV072, NAGV072R, NAGV101, NAGV101R, NAGV102, NAGV102R		



# solenoid valves

## solenoid valves (water)

ELBI

straight



<b>GEV No.</b>	373021	<b>Ref. No.</b>	65110040 65115000 LAR65110040 LAR65115000
<b>description</b>	solenoid valve double straight 230VAC inlet 3/4" outlet 11.5mm output 1x 4.7l/min DN10 ELBI		
<b>For models:</b>	CG105M, CVE105H, CVE105M, CVG105H, CVG105M, EM006H, EM006M+SC, EM010H, EM010M+SC, EM020M, EM106H, EM106M, EM106M+SC, EM106P, EM110H, EM110M, EM110M+SC, EM110P, EM210H, EM210M, EM210M+SC, EM210P, FME61A, FME61S, GM020H, GM020M, GM106H, GM106M, GM106M+SC, GM106P, GM110H, GM110M, GM110M+SC, GM110P, GM210H, GM210M, GM210M+SC, GM210P, ME106D, ME106H, ME106L, ME106M, ME106P, ME106S, ME106T, ME106X, ME110D, ME110H, ME110L, ME110M...(Other models you can see in the webshop)		
<b>spare parts for</b>	373021		
	<b>GEV No.</b>	370467	<b>Ref. No.</b> —
	solenoid valve filter suitable for ELBI		
	<b>GEV No.</b>	371263	<b>Ref. No.</b> —
	reducer ELBI flow rate 4.7l/min pressure range 0 up to 10bar tolerance ±15/25% grey		



<b>GEV No.</b>	373017	<b>Ref. No.</b>	50102860 65110010 LA65110010 LAR50102860 LAR65110010
<b>description</b>	solenoid valve single straight 230VAC inlet 3/4" outlet 11.5mm DN10 ELBI		
<b>For models:</b>	EM006M+SC, EM010M+SC, EM020M, EM106M, EM106M+SC, EM110M, EM110M+SC, EM210M, EM210M+SC, EV006M, EV006P, EV010H, EV010M, EV010P, EV020M, EV106H, EV106M, EV106M+SC, EV106P, EV110H, EV110M, EV110M+SC, EV110P, EV210H, EV210M, EV210M+SC, EV210P, FE05, FE051M, FE051X, FE101M, FE101X, FE102M, FE102X, FE105M, FE105X, FE110M, FE110X, FE210M, FE210X, FE1102P, FG05, FG051M, FG051X, FG101M, FG101X, FG102M, FG102X, FG105M, FG105X...(Other models you can see in the webshop)		
<b>spare parts for</b>	373017		
	<b>GEV No.</b>	370467	<b>Ref. No.</b> —
	solenoid valve filter suitable for ELBI		

	<b>GEV No.</b>	370360	<b>Ref. No.</b>	65115040 LAR65115040
<b>description</b>	solenoid valve single straight 230VAC inlet 3/4" outlet 11.5mm output 0.25l/min t.max. 90°C ELBI plastic flow regulating valve outlet white flow regulating valve inlet clear			
<b>For models:</b>	CE110M, CE210M, CEC40M, CES24M, CES40M, CG110M, CG210M, CGC24M, CGC40M, CGS24M, CGS40M, ECO20M, EC110M, EC210M, EV010M, EV020M, EV110M, EV110M+SC, EV210M, EV210M+SC, FME101AX, GC010M, GC020M, GC110M, GC210M, GV010M, GV110M, GV110M+SC, GV210M, GV210M+SC, PE005D, PE008D, PE015D, PE088D, PG005D, PG008D, PG015D, PG088D, VE106D, VE106H, VE106M, VE106P, VE106X, VE110D, VE110H, VE110M, VE110P, VE110X, VE210D, VE210H...(Other models you can see in the webshop)			

	<b>GEV No.</b>	370359	<b>Ref. No.</b>	65115050 LAR65115050
<b>description</b>	solenoid valve double straight 230VAC inlet 3/4" outlet 11.5mm input 5.5l/min t.max. 90°C ELBI plastic flow regulating valve inlet yellow output A 5.5l/min output B 2l/min output A brown output B white			
<b>For models:</b>	CVE004H, CVE004M, CVE104H, CVE104M, VE004D, VE004H, VE004M, VE004S, VE004X, VE104D, VE104H, VE104M, VE104S, VE104X			

	<b>GEV No.</b>	370357	<b>Ref. No.</b>	50102891 61115000 LAR50102891 LAR61115000
<b>description</b>	solenoid valve double straight 230VAC inlet 3/4" outlet 11.5mm plastic flow regulating valve outlet A 0.25			
<b>For models:</b>	FV03, FV06, ME05, ME10, ME15, ME20, ME21, ME24, ME40, MG05, MG10, MG15, MG20, MG21, MG24, MG40			





1

<b>GEV No.</b>	370361	<b>Ref. No.</b>	65115060 LAR65115060
<b>description</b>	solenoid valve double straight 230VAC inlet 3/4" outlet 11.5mm plastic output A 0.25l/min		
<b>For models:</b>	FME201SX, FMG201A, FMG201S, VE120D, VE120H, VE120L, VE120M, VE120P, VE120S, VE120X, VE220D, VE220H, VE220M, VE220P, VE220X, VEC20M, VEC20X, VEC40M, VEC40X, VES20M, VES20X, VES40M, VES40X, VG120D, VG120H, VG120M, VG120P, VG120X, VG220D, VG220H, VG220M, VG220P, VG220X, VGS20M, VGS20X, VGS40M, VGS40X		



2

<b>GEV No.</b>	370358	<b>Ref. No.</b>	65115010 LAR65115010
<b>description</b>	solenoid valve double straight 230VAC inlet 3/4" outlet 11.5mm t.max. 90°C ELBI plastic output A 2l/min output B 2l/min		
<b>For models:</b>	ME004L, ME004S, ME104L, ME104S		

spare parts and accessories

reducers

outlet side



1

<b>GEV No.</b>	371060	<b>Ref. No.</b>	65110520 LA65110520 LAR65110520
<b>description</b>	reducer ELBI flow rate 0.25l/min pressure range 0 up to 10bar tolerance ±15/25% green		
<b>For models:</b>	ABE084S, ABE104S, ABG084X, ABG104X, ARGN084, ARG5084, AVG10D, AVG20D, EVEA20S, GEVT20S, GEVT20X, GEVT40S, GEVT40X, GGVT10S, GGVT10X, GGVT20S, GGVT20X, GGVT40S, GGVT40X, KVE102S, KVE102X, KVE202S, KVE202X, KVEA20S, KVEA20X, KVG072X, KVG101X, KVG102X, KVG202X, KVG202X, LVES102, LVES202, LVET102, LVET202, LVGS072, LVGS101, LVGS102, LVGS202, LVGT072, LVGT101, LVGT102, LVGT202, MGVT10D, MGVT10P, NAEV102, NAEV102R, NAEV202, NAEV202R, NAGV072, NAGV072R...(Other models you can see in the webshop)		

RPE



1

<b>GEV No.</b>	374021	<b>Ref. No.</b>	6042071
<b>description</b>	solenoid valve double straight 230VAC inlet 3/4" outlet 10mm DN10 RPE		
<b>For models:</b>	VE102MX		



1

<b>GEV No.</b>	374025	<b>Ref. No.</b>	6042080
<b>description</b>	solenoid valve triple straight 230VAC inlet 3/4" outlet 10mm DN10 RPE		
<b>For models:</b>	VE102MX		

JOHN GUEST



1

<b>GEV No.</b>	374032 <sup>1</sup>	<b>Ref. No.</b>	65110230 LAR65110230
<b>description</b>	solenoid valve double straight 230VAC inlet 3/4" outlet 10mm DN10 plastic output A w/t membrane (constantly open)		
<b>For models:</b>	AREN064, AREN084, ARES064, ARES084, ARES154, ARGN064, ARGN084, ARG5064, ARG5084, ARG5154, AVE07D, AVE07P, AVE10D, AVE10P, AVG05P, AVG10D, AVG20D, BPE044P, BPE054P, BPE064P, BPE074P, BPE084P, BPE104P, BPG044P, BPG054P, BPG064P, BPG074P, BPG084P, BPG104P, CEV026S, CEV026X, CEV061S, CEV061X, CKES10, CME061X, CVE024S, CVE024X, CVE061S, CVE061X, CVG061S, CVG061X, EVEA20S, EVT06D, EVT06P, EVT10P, EVT20D, GEMT20T, GEVT06P, GEVT06S, GEVT06T...(Other models you can see in the webshop)		

<sup>1</sup>cylindrical outlet





1

<b>GEV No.</b>	370768 <sup>1</sup>	<b>Ref. No.</b>	65110200 LA65110200 LAR65110200
<b>description</b>	solenoid valve single straight 230VAC inlet 3/4" outlet 10mm input/min output/min DN10 t.max. 90°C duty cycle 100% RPE		
<b>For models:</b>	ABE044M, ABE054M, ABE156X, ABG064M, ABG074M, ABG156S, ACE04M, ACE05M, ACE10M, ACG10M, AME07D, AME07P, AME10D, APE06, APE07, APG08M, APG10M, AREN064, AREN084, ARES064, ARES084, ARGN064, ARGN084, ARG5064, ARG5084, AVE07D, AVE07P, AVE10D, AVE10P, AVG05P, AVG10D, AVG20D, BPE044M, BPE054M, BPE064M, BPE074M, BPE084M, BPE104M, BPG044M, BPG054M, BPG064M, BPG074M, BPG084M, BPG104M, CE041M, CE051M, CE071M, CE100M, CE200M, CEV026S...(Other models you can see in the webshop)		

<sup>1</sup>cylindrical outlet



reducers			
outlet side			
			
1			
<b>GEV No.</b>	371269	<b>Ref. No.</b>	65110420 65110500 LA65110500 LAR65110420 LAR65110500
<b>description</b>	reducer flow rate 0.07-0.14l/min brown		
<b>For models:</b>	ABE044M, ABE054M, ACE04M, ACE05M, AME07D, AME07P, APE06, APE07, AREN064, ARES064, AVE07D, AVE07P, AVG05P, BPE044M, BPE044P, BPE054M, BPE054P, BPE064M, BPE064P, BPE074M, BPE074P, BPG044M, BPG044P, BPG054M, BPG054P, BPG064M, BPG064P, BPG074M, BPG074P, CBEN061, CBES061, CE041M, CE051M, CE071M, CEV026S, CEV026X, CEV061S, CEV061X, CEV101S, CEV101X, CG051M, CME061S, CME061X, COEN026, COEN061, COEN101, COES026, COES061, COES101, CVE004H...(Other models you can see in the webshop)		



			
1			
<b>GEV No.</b>	371265	<b>Ref. No.</b>	6042097
<b>description</b>	reducer flow rate 3l/min black		
<b>For models:</b>	VE102MX		

solenoid valves with reducers

single			
			
1			
<b>GEV No.</b>	374105	<b>Ref. No.</b>	LAR65110150
<b>description</b>	solenoid valve single straight 230VAC inlet 3/4" outlet 13 input 10-12l/min t.max. 25°C duty cycle 100% RPE type B plastic flow regulating valve outlet green flow regulating valve inlet white		

2-fold

			
1			
<b>GEV No.</b>	374031	<b>Ref. No.</b>	65110210 LAR65110210
<b>description</b>	solenoid valve double straight 230VAC inlet 3/4 outlet JG 10 input 10-12l/min t.max. 90°C RPE plastic flow regulating valve inlet white + outlet reducer red		
<b>For models:</b>	ABE084S, ABE104S, ABG084X, ABG104X, AME07D, AME07P, AME10D, CEV026S, CEV026X, CEV061S, CEV061X, CEV101S, CEV101X, CKES10, CME061S, CME061X, CVE024S, CVE024X, CVE061S, CVE061X, CVG061S, CVG061X, EMT06D, EMT10D, EMT20P, EMT21P, EVEA20S, GEMT06P, GEMT06T, GEMT07S, GEMT07X, GEMT10P, GEMT10S, GEMT10T, GEMT10X, GEMT20P, GEMT20S, GEMT20T, GEMT20X, GEMT21P, GEMT21S, GEMT21T, GEMT21X, GEMT40S, GEMT40X, GEVT06S, GEVT07S, GEVT07X, GEVT10S, GEVT10X...(Other models you can see in the webshop)		

			
1			
<b>GEV No.</b>	374011	<b>Ref. No.</b>	65110160 LAR65110160
<b>description</b>	solenoid valve double straight 230VAC inlet 3/4" outlet 1/4" input 10-12l/min t.max. 25°C RPE plastic flow regulating valve inlet white output A 0.2 - 3l/min output B 0.2 - 3l/min flow regulating valve outlet A red flow regulating valve outlet B red		
<b>For models:</b>	A08PES+UM, A08RES+UM, A10PES+UM, A10RES+UM		
<b>spare parts for</b>	374011		
		<b>GEV No.</b>	371315
		<b>Ref. No.</b>	—
	solenoid valve holder RPE flange support		

3-fold

			
1			
<b>GEV No.</b>	374014 <sup>1</sup>	<b>Ref. No.</b>	65110280 LAR65110280
<b>description</b>	solenoid valve triple straight 230VAC inlet 3/4" outlet 10mm input 10-12l/min RPE plastic flow regulating valve inlet white flow regulating valve outlet A red/green flow regulating valve outlet B red/green flow regulating valve outlet C red/green		
<b>For models:</b>	AREN154, ARGN154, GEMT21S, GEMT21X, GEMT40P, GEMT40S, GEMT40T, GEMT40X, GEVT21S, GEVT21X, GEVT40S, GEVT40X, GGMT21P, GGMT21S, GGMT21T, GGMT21X, GGMT40P, GGMT40S, GGMT40T, GGMT40X, GGVT21S, GGVT21X, GGVT40P, GGVT40S, GGVT40T, GGVT40X, HME201X, HME202P, HME202S, HME202T, HME202X, HMG201P, HMG201T, HMG201X, HMG202P, HMG202T, HMG202X, HVG202P, HVG202T, HVG202X, KMG201S, KMG201X, KMG202S, KMG202X, LBES201, LBES202, LBET201, LBET202, LBGS201, LBGS202...(Other models you can see in the webshop)		

<sup>1</sup>cylindrical outlet

			
1			
<b>GEV No.</b>	374033	<b>Ref. No.</b>	65110240 LAR65110240
<b>description</b>	solenoid valve triple straight 230VAC inlet 3/4" outlet 10mm input 10-12l/min t.max. 90°C RPE plastic flow regulating valve inlet white output B w/t membrane (constantly open)		
<b>For models:</b>	ABE084S, ABE104S, ABG084X, ABG104X, AREN064, AREN084, AREN154, ARES064, ARES084, ARES154, ARGN064, ARGN084, ARGN154, ARGS064, ARGS084, ARGS154, CEV101S, CEV101X, EPE056T, EPE086T, EPE156T, EPEV05T, EPEV08T, EPEV15T, EPG056T, EPG086T, EPG156T, EPGV05T, EPGV08T, EPGV15T, GEMT06P, GEMT06T, GEMT10P, GEMT10T, GEMT20P, GEMT20T, GEMT21P, GEMT21T, GEMT40P, GEMT40T, GEVT06P, GEVT06T, GEVT10P, GEVT10T, GEVT20P, GEVT20T, GEVT21P, GEVT21S, GEVT21T, GEVT21X...(Other models you can see in the webshop)		



TP			
spare parts and accessories			
reducers			
outlet side			
			
1			
<b>GEV No.</b>	691081	<b>Ref. No.</b>	65110410 LA65110410 LAR65110410
<b>description</b>	reducer flow rate 0.25l/min green tolerance ±25%		
<b>For models:</b>	CG105M, CVE105H, CVE105M, CVG105H, CVG105M, EV010P, EV110P, EV210H, EV210P, FEI102P, GV010H, GV020H, GV110H, GV110P, GV210H, GV210P, VE105D, VE105H, VE105M, VE105NS, VE105S, VE105X, VE110D, VE110H, VE110L, VE110P, VE110S, VE110T, VE155H, VE155M, VE155X, VE210D, VE210H, VE210L, VE210P, VE210S, VE210T, VEC20P, VES20D, VES20H, VES20P, VES24D, VES24H, VES24P, VES40D, VES40H, VES40P, VG105D, VG105H, VG105M...(Other models you can see in the webshop)		

various			
			
1			
<b>GEV No.</b>	370363	<b>Ref. No.</b>	65110260 LA65110260 LAR65110260
<b>description</b>	solenoid valve single straight cable length 600mm suitable for LAINOX		
<b>For models:</b>	EMT20P, EMT21P, EPE056T, EPE086T, EPE156T, EPEV05T, EPEV08T, EPEV15T, EPG056T, EPG086T, EPG156T, EPGV05T, EPGV08T, EPGV15T, GEMT06P, GEMT06T, GEMT10P, GEMT10T, GEMT20P, GEMT20T, GEMT21P, GEMT21T, GEMT40P, GEMT40T, GEVT06P, GEVT06T, GEVT10P, GEVT10T, GEVT20P, GEVT20T, GEVT21P, GEVT21T, GEVT40P, GEVT40T, GGMT06P, GGMT06T, GGMT10P, GGMT10T, GGMT20P, GGMT20T, GGMT21P, GGMT21T, GGMT40P, GGMT40T, GGVT06P, GGVT06T, GGVT10P, GGVT10T, GGVT20P, GGVT20T...(Other models you can see in the webshop)		

metal			
CEME			
solenoid valves			
			
1			
<b>GEV No.</b>	370352	<b>Ref. No.</b>	6042075
<b>description</b>	solenoid valve 2-ways 230VAC inlet 1/2" IT outlet 1/2" IT L 55mm p max 0.5bar brass		
<b>For models:</b>	VE102MX		

Solenoid valve - accessories			
			
1			
<b>GEV No.</b>	530903	<b>Ref. No.</b>	65090300 LA65090300 LAR65090300
<b>description</b>	solenoid coil plug type F6.3x0.8 230V for combi-steamer		
<b>For models:</b>	CBEN061, CBES061, CEV026S, CEV026X, CEV061S, CEV061X, CEV101S, CEV101X, CME061S, CME061X, COEN026, COEN061, COEN101, COES026, COES061, COES101, CVE024S, CVE024X, CVE061S, CVE061X, CVEN061, CVES061, CVG061S, CVG061X, CVGN061, CVGS061, KME061S, KME061X, KVE061S, KVE061X, KVG061X, REP044S, REP054S, REP064S, REP074S, REP084S, REP104S, REV051S, REV071S, REV101S, RGP044S, RGP054S, RGP064S, RGP074S, RGP084S, RGP104S, RGV051S, RGV071S, RGV101S, SVE042S...(Other models you can see in the webshop)		



## ball valves electric



<b>GEV No.</b>	403842	<b>Ref. No.</b>	65110570 LAR65110570 LAR65110571
<b>description</b>	ball valve inlet 1" IT outlet 1" IT for combi-steamer 2-way 230V 50/60Hz brass mode of operation electric 3-pole-pole		
<b>For models:</b>	GEMT07S, GEMT07X, GEMT10S, GEMT10X, GEMT20S, GEMT20X, GEMT21S, GEMT21X, GEMT40S, GEMT40X, GGMT07S, GGMT07X, GGMT10S, GGMT10X, GGMT20S, GGMT20X, GGMT21S, GGMT21X, GGMT40S, GGMT40X, KME072S, KME072X, KME081S, KME081X, KME101S, KME101X, KME102X, KME201S, KME201X, KMEA20S, KMEA20X, KMG072S, KMG072X, KMG081S, KMG081X, KMG101S, KMG101X, KMG102S, KMG102X, KMG201S, KMG201X, KMG202S, KMG202X, KMGA20S, KMGA20X, LBES071, LBES072, LBES101, LBES102, LBES201...(Other models you can see in the webshop)		

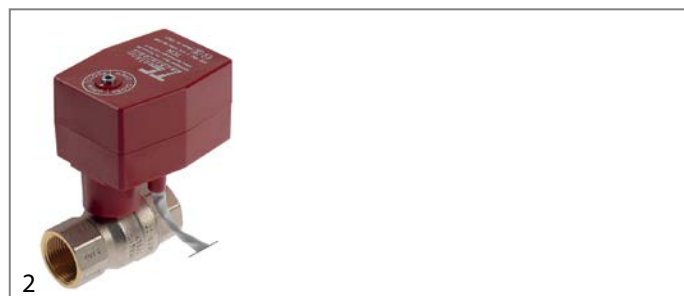

<b>GEV No.</b>	403042	<b>Ref. No.</b>	65110560 LAR65110560
<b>description</b>	ball valve inlet 3/4" IT outlet 3/4" IT 230V L 68mm closed off-current mode of operation electric connection cable 400mm		
<b>For models:</b>	AME07D, AME07P, AME10D, CBEN061, CBES061, CME061S, CME061X, EMT06D, EMT10D, EMT20P, EMT21P, GEMT06P, GEMT06T, GEMT10P, GEMT10T, GEMT20P, GEMT20T, GEMT21P, GEMT21T, GEMT40P, GEMT40T, GGMT06P, GGMT06T, GGMT10P, GGMT10T, GGMT20P, GGMT20T, GGMT21P, GGMT21T, GGMT40P, GGMT40T, GMT06D, GMT06P, GMT20D, GMT20P, GSE201N, HME061P, HME061T, HME061X, HME101P, HME101S, HME101T, HME101X, HME102P, HME102S, HME102T, HME102X, HME201P, HME201S, HME201T...(Other models you can see in the webshop)		

## pressure switches

### for gas equipment

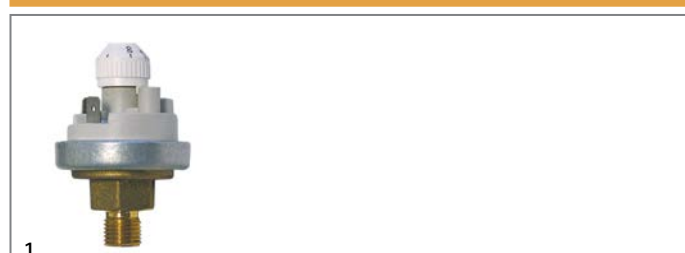

<b>GEV No.</b>	541073	<b>Ref. No.</b>	63070010 LA63070010 LAR63070010
<b>description</b>	pressure control ø 45mm pressure range adjustable 5-20mbar pressure connection vertical gas technology connection 1/4" pressure connection ø 1/4"mm		
<b>For models:</b>	ABG064M, ABG074M, ABG084X, ABG104X, ABG156S, ACG10M, APG08M, APG10M, ARGN064, ARGN084, ARGN154, ARGS064, ARGS084, ARGS154, AVG05P, AVG10D, AVG20D, BPG044M, BPG044P, BPG054M, BPG054P, BPG064M, BPG064P, BPG074M, BPG074P, BPG084M, BPG084P, BPG104M, BPG104P, CG051M, CG071M, CG100M, CG105M, CG106M, CG110M, CG200M, CG210M, CGC24M, CGC40M, CGS24M, CGS40M, CVG061S, CVG061X, CVG105H, CVG105M, CVGN061, CVGS061, EPG056T, EPG086T, EPG156T...(Other models you can see in the webshop)		

### for steam control

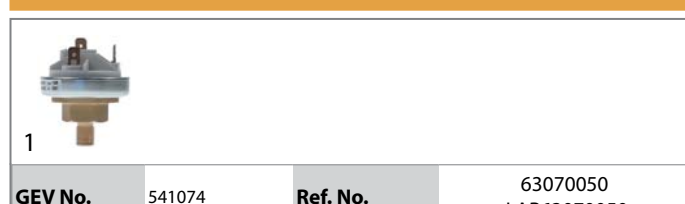

<b>GEV No.</b>	541074	<b>Ref. No.</b>	63070050 LAR63070050
<b>description</b>	pressure control ø 45mm triggering pressure 0.5bar reset pressure 0.35bar pressure connection vertical steam control pressure range 0.35/0.51bar connection 1/8" pressure connection 1/8"		
<b>For models:</b>	ABE084S, ABE104S, ABG084X, ABG104X, ABG156S, AREN064, AREN084, AREN154, ARES064, ARES084, ARES154, ARGN064, ARGN084, ARGN154, ARGS064, ARGS084, AVE07D, AVE07P, AVE10D, AVE10P, AVG05P, AVG10D, AVG20D, BPE044P, BPE054P, BPE064M, BPE064P, BPE074M, BPE074P, BPE084M, BPE084P, BPE104M, BPE104P, BPG044P, BPG054P, BPG064M, BPG064P, BPG074M, BPG074P, BPG084M, BPG084P, BPG104M, BPG104P, CEV026S, CEV026X, CEV061S, CEV061X, CEV101S, CEV101X, CKES10...(Other models you can see in the webshop)		

## electrodes





<b>GEV No.</b>	401161	<b>Ref. No.</b>	6000089
<b>description</b>	level electrode 1/4" total length 210mm probe L 184mm insulated probe length 26mm connection male faston 6.3mm stainless steel ø 2.5mm		
<b>For models:</b>	VE102MX		

→ electric components

			
1			
<b>GEV No.</b>	400171	<b>Ref. No.</b>	0102478 65324720 LAR65324720 R0102478 SIR0102478
<b>description</b>	level electrode 1/4" total length 350mm probe L 325mm insulated probe length 26mm connection male faston 6.3mm stainless steel ø 2.5mm		
<b>For models:</b>	MG105L, MG105S		

			
1			
<b>GEV No.</b>	403106	<b>Ref. No.</b>	65324740 LAR65324740
<b>description</b>	level electrode M14x1.25 total length 155mm probe L 129mm insulated probe length 26mm connection male faston 6.3mm ø 2.5mm		
<b>For models:</b>	MG106L, MG106S, MG106T, MG110L, MG110S, MG110T		

			
1			
<b>GEV No.</b>	403105	<b>Ref. No.</b>	65324780 LAR65324780
<b>description</b>	level electrode M14x1.25 total length 178mm probe L 150mm insulated probe length 26mm connection male faston 6.3mm ø 2.5mm		
<b>For models:</b>	MG106L, MG106S, MG106T, MG110L, MG110S, MG110T		

			
1			
<b>GEV No.</b>	400130	<b>Ref. No.</b>	65320010 65324680 65324730 LA65320010 LAR65320010 LAR65324680 LAR65324730
<b>description</b>	level electrode M14x1.25 total length 220mm probe L 194mm insulated probe length 26mm connection male faston 6.3mm ø 2.5mm		
<b>For models:</b>	AME07D, AME07P, AME10D, CBEN061, CBES061, CME061S, CME061X, EM006H, EM006M+SC, EM010H, EM010M+SC, EM020M, EM106H, EM106M, EM106M+SC, EM106P, EM110H, EM110M, EM110M+SC, EM110P, EM210H, EM210M, EM210M+SC, EM210P, EMT06D, EMT10D, EMT20P, EMT21P, GEMT06P, GEMT06T, GEMT07S, GEMT07X, GEMT10P, GEMT10S, GEMT10T, GEMT10X, GEMT20P, GEMT20S, GEMT20T, GEMT20X, GEMT21P, GEMT21S, GEMT21T, GEMT21X, GEMT40P, GEMT40S, GEMT40T, GEMT40X, GGMT06P, GGMT06T...(Other models you can see in the webshop)		



			
1			
<b>GEV No.</b>	400054	<b>Ref. No.</b>	65324620 LAR65324620
<b>description</b>	level electrode total length 107mm probe L 73mm insulated probe length 18mm connection male faston 6.3mm ø 2.5mm thread M14x1.25		
<b>For models:</b>	ME105L, ME105S, ME106L, ME106S, ME106T		

## fans

### axial fans

#### ebm-papst



1			
<b>GEV No.</b>	601030 <sup>1</sup>	<b>Ref. No.</b>	3102350 65060050 BN3102350 LA65060050 LAR65060050
<b>description</b>	axial fan L 119mm W 119mm H 38mm 230VAC 50Hz 18W bearing ball bearing manuf. no. 4656Z metal connection male faston 2.8mm ebm-papst fan wheel ø 110mm temp.-resist. 75°C		
<b>For models:</b>	ABE084S, ABE104S, ABE156X, ABG064M, ABG074M, ABG084X, ABG104X, ABG156S, ACE10M, ACG10M, AME07D, AME07P, AME10D, APE06, APE07, APG08M, APG10M, AREN064, AREN084, AREN154, ARES064, ARES084, ARES154, ARGN064, ARGN084, ARGN154, ARGS064, ARGS084, ARGS154, AVE07D, AVE07P, AVE10D, AVE10P, AVG10D, AVG20D, BPE064M, BPE064P, BPE074M, BPE074P, BPE084M, BPE084P, BPE104M, BPE104P, BPG064M, BPG064P, BPG074M, BPG074P, BPG084M, BPG084P, BPG104M...(Other models you can see in the webshop)		
<b>accessories for</b>	601030		
		<b>GEV No.</b>	550898
		<b>Ref. No.</b>	—
	connecting cable cable length 2000mm connection F 2.8 connection distance 7.9mm for axial flow fan		
		<b>GEV No.</b>	692497
		<b>Ref. No.</b>	—
	guard ø 105mm mounting distance 150mm for axial fan ebm-papst-mm		

<sup>1</sup>with ball bearings





import



<b>GEV No.</b>	601080 <sup>1</sup>	<b>Ref. No.</b>	6033175
<b>description</b>	axial fan L 119mm W 119mm H 38mm 230VAC 50/60Hz 23/20W bearing ball bearing connection male faston 2.8mm metal ADDA fan wheel ø 110mm temp.-resist. 70°C		
<b>For models:</b>	VE102MX		
<b>accessories for</b>	601080		
	<b>GEV No.</b>	550898	<b>Ref. No.</b> —
	connecting cable cable length 2000mm connection F 2.8 connection distance 7.9mm for axial flow fan		
	<b>GEV No.</b>	692519	<b>Ref. No.</b> —
	guard L 120mm W 120mm plastic		

<sup>1</sup>with ball bearings



<b>GEV No.</b>	601081 <sup>1</sup>	<b>Ref. No.</b>	65060010 LA65060010 LAR65060010
<b>description</b>	axial fan L 80mm W 80mm H 38mm 230VAC 50/60Hz 14/13.5W bearing ball bearing connection male faston 2.8mm metal ADDA fan wheel ø 75mm temp.-resist. 70°C		
<b>For models:</b>	AREN084, ARGN084, ARG5084, AVG05P, BPE044P, BPE054P, BPG044M, BPG044P, BPG054M, BPG054P, CEV026S, CEV026X, CEV061S, CEV061X, CEV101S, CEV101X, CG105M, CKES10, COEN026, COEN061, COEN101, COES026, COES061, COES101, CVE024S, CVE024X, CVE105H, CVE105M, CVG105H, CVG105M, FG051M, FG051X, FME101AX, FME201SX, FME61A, FME61S, FMG201A, FMG201S, GEMT10S, GEMT10X, GEVT10S, GEVT10X, GGMT10S, GGMT10X, GGVT10S, GGVT10X, MCG051M, ME105L, ME105S, ME106D...(Other models you can see in the webshop)		
<b>accessories for</b>	601081		
	<b>GEV No.</b>	691102	<b>Ref. No.</b> —
	guard ø 75mm mounting distance 71mm for axial fan 80mm		

<sup>1</sup>with ball bearings

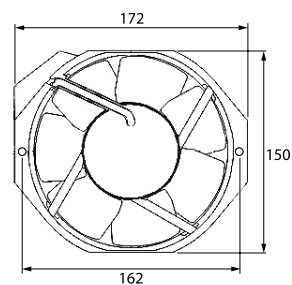

<b>GEV No.</b>	602151	<b>Ref. No.</b>	65060060 LA65060060 LAR65060060
<b>description</b>	axial fan L 172mm W 150mm H 51mm 220-240V 50-60Hz manuf. no. AA1752HB-AW connection cable cable length 3000mm ADDA suitable for combi-steamer fan wheel ø 140mm 0.27/0.23A		
<b>For models:</b>	EPE156T, EPEV15T, GSE201N, HME201P, HME201S, HME201T, HME201X, HMG201P, HMG201T, HMG201X, HVE201P, HVE201S, HVE201T, HVE201X, HVG201P, HVG201T, HVG201X, MCE201M, MCG201M, ME101H, ME101M, ME101P, ME101T, ME201D, ME201H, ME201M, ME201P, ME201T, ME202D, ME202H, ME202M, ME202P, ME202T, MEMT40D, MEMT40P, MEVT40D, MEVT40P, MG101H, MG101M, MG101P, MG101T, MG201D, MG201H, MG201M, MG201P, MG201T, MG202D, MG202H, MG202M, MG202P...(Other models you can see in the webshop)		

hot air motors



<b>GEV No.</b>	550857	<b>Ref. No.</b>	58003870 LA58003870 LAR58003870
<b>description</b>	counterflange for fan motor ED ø 50mm int. ø 1 25mm int. ø 2 16mm thickness 6mm brass		
<b>For models:</b>	AME07D, AME07P, APE06, APE07, AREN064, ARES064, ARGN064, ARG5064, AVE07D, AVE07P, BPE064M, BPE064P, BPE074M, BPE074P, BPG064M, BPG064P, BPG074M, BPG074P, CE071M, CE106M, CG071M, CG105M, CG106M, CVE105H, CVE105M, CVG105H, CVG105M, EC106M, EM006H, EM006M+SC, EM106H, EM106M, EM106M+SC, EM106P, EMT06D, EV006M, EV006P, EV106H, EV106M, EV106M+SC, EV106P, EVT06D, EVT06P, FE051M, FE051X, FE105M, FE105X, FG051M, FG051X, FG105M...(Other models you can see in the webshop)		



<b>GEV No.</b>	550859	<b>Ref. No.</b>	58003850 LA58003850 LAR58003850
<b>description</b>	counterflange for fan motor ED ø 60mm int. ø 1 34mm int. ø 2 25mm thickness 6mm brass		
<b>For models:</b>	ABE084S, ABE104S, ABE156X, ABG064M, ABG074M, ABG084X, ABG104X, ABG156S, ACE10M, ACG10M, AME10D, APG08M, APG10M, AREN084, AREN154, ARES084, ARES154, ARGN084, ARGN154, ARG5084, ARG5154, AVE10D, AVE10P, AVG10D, AVG20D, BPE084M, BPE084P, BPE104M, BPE104P, BPG084M, BPG084P, BPG104M, BPG104P, CE100M, CE110M, CE200M, CE210M, CEC40M, CES24M, CES40M, CG100M, CG110M, CG200M, CG210M, CGC24M, CGC40M, CGS24M, CGS40M, CKES10, EC020M...(Other models you can see in the webshop)		

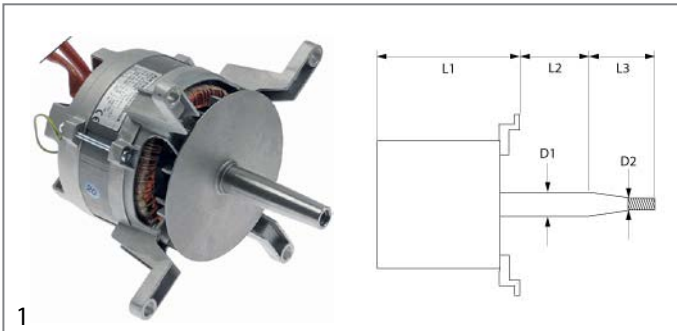

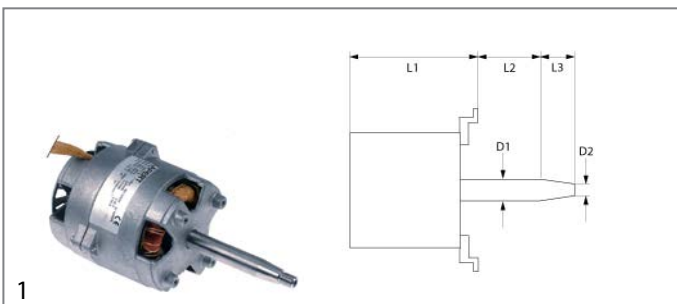

<b>GEV No.</b>	500656	<b>Ref. No.</b>	65040520 LAR65040520
<b>description</b>	fan motor 200-240/415V 3 phase 50/60Hz 0.15/0.55kW 900/1400rpm speeds 2 L1 150mm L2 50mm L3 48mm D1 ø 24mm D2 ø 20mm M12L IT 2.3/1.3-1.2/0.7A at 50Hz 200-240/415V at 60Hz 200-240/480V at 50Hz 900/1400rpm at 60Hz 1100/1700rpm type 3042D4050		
<b>For models:</b>	ABE084S, ABE104S, AREN084, AREN154, ARES084, ARES154, ARGN084, ARGN154, AVE10P, BPE084M, BPE084P, BPE104M, BPE104P, EMT20P, EVEA20S, GEMT10S, GEMT10X, GEMT20S, GEMT20X, GEMT21S, GEMT21X, GEMT40S, GEMT40X, GEVT10S, GEVT10X, GEVT20S, GEVT20X, GEVT21S, GEVT21X, GEVT40S, GEVT40X, GGMT10X, GGMT20X, GGMT21X, GGMT40X, GGV10X, GGV20X, GGV21X, GGV40X, KME072S, KME072X, KME101S, KME101X, KME102X, KME201S, KME201X, KME202S, KME202X, KMEA20S, KME-A20X...(Other models you can see in the webshop)		

<b>spare parts for</b>	500656			50505890 70020050 LA70020050 LAR50505890 LAR70020050 R50505890 R70020050
	<b>GEV No.</b>	511172	<b>Ref. No.</b>	
shaft sealing ID ø 24mm ED ø 29mm thickness 3mm				

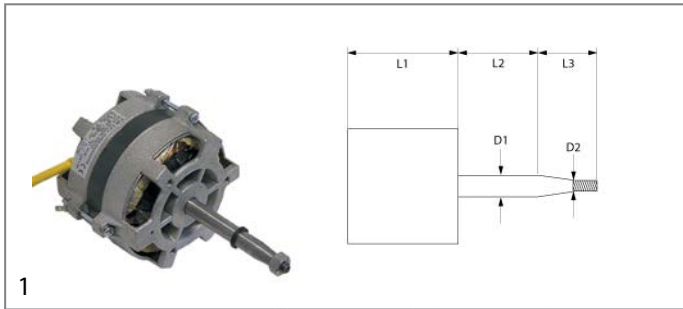

<b>GEV No.</b>	500671	<b>Ref. No.</b>	65040070 65040071 LAR65040070 LAR65040071
<b>description</b>	fan motor 200-240V 1 phase 50/60Hz 0.11kW 2760/3320rpm speeds 1 L1 130mm L2 55mm L3 30mm D1 ø 15mm D2 ø 12mm M10L ET at 50Hz 2760rpm at 60Hz 3320rpm		
<b>For models:</b>	CG105M, CVE105H, CVE105M, CVG105H, CVG105M, ME105L, ME105S, MG105L, MG105S, VE105D, VE105M, VE105NS, VE105S, VE105X, VE155M, VE155X, VG105D, VG105H, VG105M, VG105S, VG105X		



<b>GEV No.</b>	500134	<b>Ref. No.</b>	50405225 65040021 LAR50405225 LAR65040021	
<b>description</b>	fan motor 200-240V 1 phase 50/60Hz 0.25HP 1400/1700rpm speeds 1 L1 115mm L2 77mm L3 30mm D1 ø 15mm D2 ø 12mm M10L ET 1A suitable capacitor 5µF/400V at 50Hz 1400rpm at 60Hz 1700rpm type 1060.1950			
<b>For models:</b>	ME106D, ME106M, ME106S, MG106D, MG106M, MG106S, VE106D, VE106L, VE106M, VE106S, VG106D, VG106L, VG106M, VG106S			
<b>accessories for</b>	500134			
	<b>GEV No.</b>	380659	<b>Ref. No.</b>	65160570 LA65160570 LAR65160570 R65160570
overload switch setting range 0.7-1A connection screw type 3RU1116-0JB0 (AC3/400V) 0.25kW				

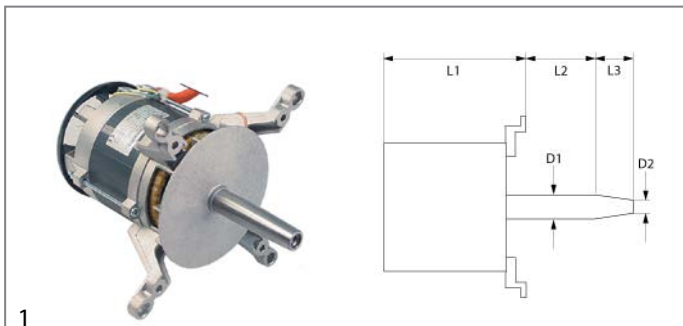

<b>GEV No.</b>	500135	<b>Ref. No.</b>	50405235 65040030 65040031 LAR50405235 LAR65040030 LAR65040031	
<b>description</b>	fan motor 200-240V 1 phase 50Hz 0.185/0.55kW 900/1400rpm speeds 2 L1 195mm L2 45mm L3 47mm D1 ø 24mm D2 ø 20mm M12L IT 3.6/2A suitable capacitor 16µF-450V/12.5µF-450V at 50Hz 900/1400rpm type 1063D2250			
<b>For models:</b>	FG101X, FG102X, FG110X, FG210X, GM020H, GM110H, GM110P, GM210H, GM210P, GMT20P, GV010H, GV020H, GV110H, GV110P, GV210H, GV210P, MG102P, MG102T, MG110H, MG110L, MG110P, MG110T, MG110X, MG120H, MG120L, MG120P, MG120T, MG120X, MG210H, MG210L, MG210P, MG210T, MG210X, MG220D, MG220H, MG220L, MG220P, MG220T, MG220X, MGC20H, MGC24H, MGC40H, MGC40P, MGMT10P, MGMT20P, MGMT21P, MGS20H, MGS20P, MGS24H, MGS24P...(Other models you can see in the webshop)			
<b>accessories for</b>	500135			
	<b>GEV No.</b>	550682	<b>Ref. No.</b>	58006410 LAR58006410 R58006410
hexagonal screw thread M8 thread L 20mm SS WS 13 Qty 1 pcs DIN 933 / ISO 4017				

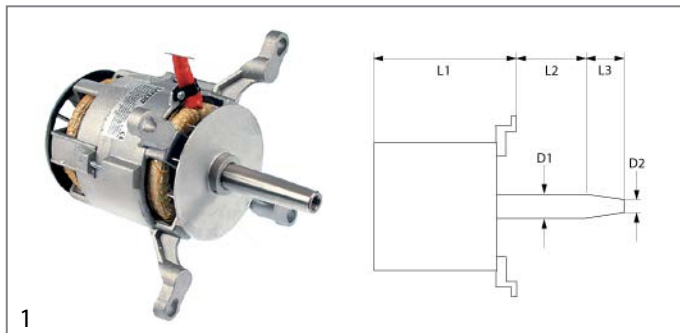

<b>GEV No.</b>	601046	<b>Ref. No.</b>	50405510 52405265 6033155 65040061 65040130 65040150 65040170 LAR50405510 LAR52405265 LAR65040061 LAR65040130 LAR65040150 LAR65040170
----------------	--------	-----------------	---

**description** fan motor 220/380V 3 phase 50/60Hz 0.75kW 1350/1650rpm speeds 1 L1 185mm L2 42mm L3 47mm D1 ø 24mm D2 ø 20mm M12L IT 1.9/3.3A Cos(f) 0.83 at 50Hz 200-240/346-415V at 60Hz 200-277/346-480V at 50Hz 1350rpm at 60Hz 1650rpm type ST80/4 no. 661512

**For models:** CE110M, CE210M, CEC40M, CES24M, CES40M, ECO20M, EC110M, EC210M, EM010M+SC, EM020M, EM110M, EM110M+SC, EM210M, EM210M+SC, EMT10D, EV010M, EV020M, EV110M, EV110M+SC, EV210M, EV210M+SC, EVT20D, FE101M, FE102M, FE110M, FE210M, FME101AX, ME10, ME102D, ME102H, ME102M, ME110D, ME110M, ME110X, ME120D, ME120M, ME15, ME20, ME202D, ME202M, ME21, ME210D, ME210M, ME210X, ME220D, ME220M, ME227M, ME24, ME40, MEC20X...(Other models you can see in the webshop)



<b>GEV No.</b>	501587	<b>Ref. No.</b>	65040051 LAR65040051
<b>description</b>	fan motor 220-240V 1 phase 50/60Hz 0.55kW 1400/1700rpm L1 190mm L2 45mm L3 47mm D1 ø 24mm D2 ø 20mm M12L IT 3.6A type 1063A2250		
<b>For models:</b>	EM010H, EM110H, EM110P, EM210H, EM210P, EMT20P, EMT21P, EV010H, EV010P, EV110H, EV110P, EV210H, EV210P, EVT10P, FE101X, FE102X, FE110X, FE210X, FEI102P, FME2015X, ME102P, ME102T, ME110H, ME110P, ME110X, ME120H, ME120P, ME120X, ME202H, ME202P, ME202T, ME210H, ME210P, ME210X, ME220H, ME220P, ME220X, ME227P, ME227X, MEC20H, MEC20P, MEC24H, MEC40H, MEC40P, MEK21H, MEMT10P, MEMT20P, MEMT21P, MEMT40P, MES20H...		

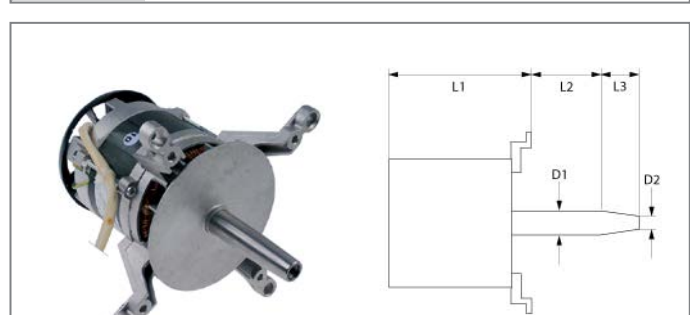

<b>GEV No.</b>	500136	<b>Ref. No.</b>	65040040 65040041 65040180 LAR65040041 LAR65040180
<b>description</b>	fan motor 220-240V 1 phase 50/60Hz 0.55kW 1400rpm speeds 1 L1 190mm L2 47mm L3 47mm D1 ø 24mm D2 ø 20mm M12L IT 3.6A suitable capacitor 16µF/450V Cos(f) 0.9 at 50Hz 1400rpm at 60Hz 1700rpm type 1063/4M		

**For models:** CG110M, CG210M, CGC24M, CGC40M, CGS24M, CGS40M, FG101M, FG102M, FG110M, FG210M, GC010M, GC020M, GC110M, GC210M, GM020M, GM110M, GM110M+SC, GM210M, GM210M+SC, GMT20D, GV010M, GV110M, GV110M+SC, GV210M, GV210M+SC, GVT20D, MG102D, MG102H, MG102M, MG110D, MG110M, MG110S, MG110X, MG120D, MG120M, MG120S, MG210D, MG210M, MG210X, MG220L, MG220M, MG220S, MGC20X, MGC40M, MGC40X, MGMT10D, MGMT20D, MGMT21D, MGS20D, MGS20M...(Other models you can see in the webshop)

**accessories for** 500136

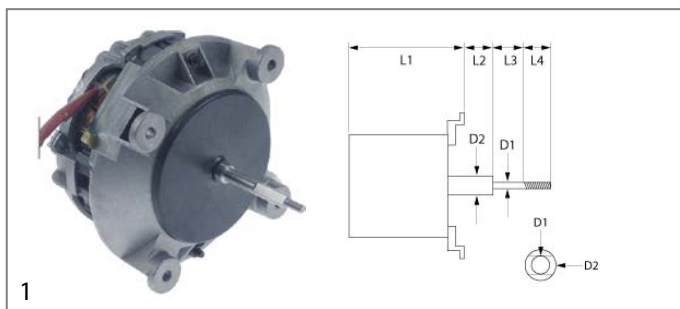

<b>GEV No.</b>	601856	<b>Ref. No.</b>	65041010 LAR65041010
----------------	--------	-----------------	-------------------------

**description** fan motor 220-240V 1 phase 50/60Hz 0.075kW 2800/3200rpm speeds 1 L1 85mm L2 30mm L3 23mm L4 12mm D1 ø 8x6mm D2 ø 8mm 0.6A suitable capacitor 5µF/400V

**For models:** CEV061S, CVE024S, CVE024X, CVE061S, REC051M, REC071M, REV051S, REV101S

**accessories for** 601856

	<b>GEV No.</b>	365017	<b>Ref. No.</b>	—
	operating capacitor capacity 5µF 450V tolerance 5% 50/60Hz ambient temperature max. -25 to +85°C ø 28mm L 54mm M8 plastic connection male faston 6.3mm 16.10.08 protection			

	<b>GEV No.</b>	560129	<b>Ref. No.</b>	LA61310322
	hexagonal nut thread M5 H 4mm WS 8 SS DIN/ISO DIN 934 / ISO 4032/8673 Qty 1 pcs			

	<b>GEV No.</b>	511172	<b>Ref. No.</b>	50505890 70020050 LA70020050 LAR50505890 LAR70020050 R50505890 R70020050
	shaft sealing ID ø 24mm ED ø 29mm thickness 3mm			

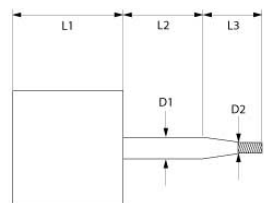
1

<b>GEV No.</b>	500661	<b>Ref. No.</b>	65040431 LAR65040431
<b>description</b>	fan motor 220-240V 1 phase 50Hz 0.03/0.2kW 0.05/0.25HP 1400/2700rpm speeds 2 L1 123mm L2 77mm L3 30mm D1 ø 15mm D2 ø 12mm M10L ET 1.6/0.6A suitable capacitor 10µF/450 V at 50Hz 1400/2700rpm type 1057D1901		
<b>For models:</b>	AME07P, APE06, APE07, AVE07P, BPE064M, BPE064P, BPE074M, BPE074P, BPG064M, BPG064P, BPG074M, BPG074P, EVT06P, GMT06P, GVT06P, ME061P, ME061T, MEMT06P, MEVT06P, MG061P, MG061T, MGMT06P, MGVT06P, MME071P, PE064M, PE064P, PE074M, PE074P, SME071S, SVE071P, SVE071S, VE061P, VG061P		



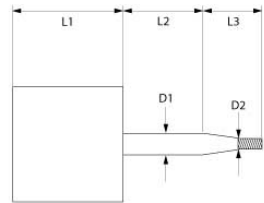

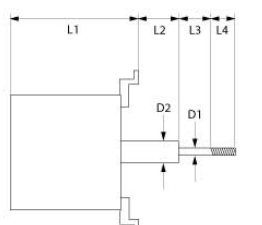

1

<b>GEV No.</b>	500133	<b>Ref. No.</b>	30405215 65040011 LAR30405215 LAR65040011
<b>description</b>	fan motor 220-240V 1 phase 50Hz 0.1/0.25HP 900/1400rpm speeds 2 L1 123mm L2 77mm L3 30mm D1 ø 15mm D2 ø 12mm M10L ET 1/0.6A suitable capacitor 5µF/450V at 50Hz 900/1400rpm at 60Hz 1100/1700rpm type 1061.1950		
<b>For models:</b>	ME106H, ME106L, ME106P, ME106T, ME106X, MG106H, MG106L, MG106P, MG106T, MG106X, VE106H, VE106P, VE106T, VE106X, VG106H, VG106P, VG106T, VG106X		



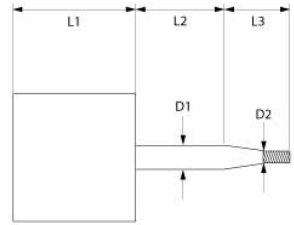

1

<b>GEV No.</b>	601354	<b>Ref. No.</b>	50405580 65040380 LAR65040380 LAR50405580 LAR65040380
<b>description</b>	fan motor 220-240V 1 phase 50Hz 0.11kW 2760rpm speeds 1 L1 130mm L2 32mm L3 30mm L4 18mm D1 ø 7/8mm D2 ø 9mm M4R IT 0.9A at 50Hz 230V at 50Hz 2760rpm suitable capacitor 4µF type LM63 shaft flat length 17mm		
<b>For models:</b>	FE05, FG05		
<b>accessories for</b>	601354		
	<b>GEV No.</b>	365031	<b>Ref. No.</b> 50405600 65190010 LAR65190010 R50405600 R65190010
operating capacitor capacity 4µF 450V tolerance 5% 50/60Hz ambient temperature max. -25 to +85°C ø 31mm L 58mm M8 plastic connection male faston 6.3mm protection			
	<b>GEV No.</b>	601061	<b>Ref. No.</b> 50405740 75400060 LAR75400060 LAR50405740 LAR75400060 R50405740 R75400060
fan wheel D1 ø 160mm H1 60mm blades 15 D2 ø 18mm D3 ø 18mm H2 35mm			

1

<b>GEV No.</b>	601043	<b>Ref. No.</b>	50405610 65040260 LAR50405610 LAR65040260
<b>description</b>	fan motor 220-240V 1 phase 50Hz 0.37/0.07kW 0.1/0.5HP 1400/2700rpm speeds 2 L1 123mm L2 107mm L3 15mm D1 ø 15mm D2 ø 12mm M10L ET 2/0.7A suitable capacitor 20µF/250V at 50Hz 1400/2700rpm type 1057		
<b>For models:</b>	FE051M, FE051X, FE105M, FE105X, FG051M, FG051X, FG105M, FG105X, ME05, MG05, MME05, PE04, PE040M, PE040X, PE041M, PE041X, PE051M, PE051X, PG04, PG040M, PG040X, PG041M, PG041X, PG051M, PG051X, RE05, RG05		
<b>accessories for</b>	601043		
	<b>GEV No.</b>	365019	<b>Ref. No.</b> 50405630
operating capacitor capacity 20µF 400V tolerance 5% 50/60Hz ambient temperature max. -25 to +85°C ø 39.5mm L 70mm M8 plastic connection male faston 6.3mm 16.10.25. protection			



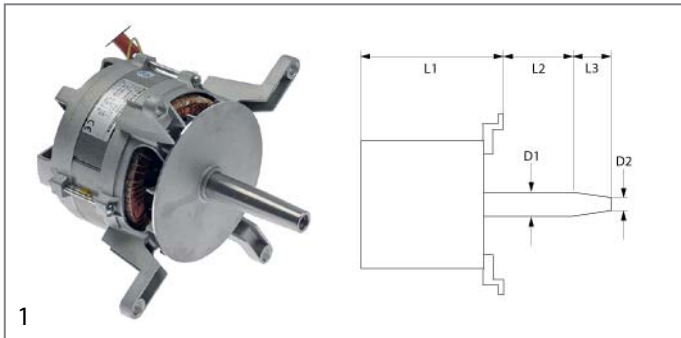

<b>GEV No.</b>	500658	<b>Ref. No.</b>	65040530 LAR65040530
----------------	--------	-----------------	-------------------------

**description** fan motor 230/400V 3 phase 50/60Hz 0.55kW 1400/1700rpm speeds 1 L1 145mm L2 47mm L3 47mm D1 ø 24mm D2 ø 20mm M12L IT 2.6-2.3/1.5-1.3A (at 50-60Hz)A Cos(φ) 0.73 at 50Hz 200-240/415V at 60Hz 200-240/480V at 50Hz 1400rpm at 60Hz 1700rpm

**For models:** ABE156X, ABG084X, ABG104X, ACE10M, AME10D, AREN084, AREN154, ARGN084, ARGN154, AVE10D, CE100M, CE200M, CKES10, EPE056T, EPE086T, EPE156T, EPEV05T, EPEV08T, EPEV15T, EPG056T, EPG086T, EPG156T, EPGV05T, EPGV08T, EPGV15T, EVEA20S, EVT20D, GEMT10P, GEMT10S, GEMT10T, GEMT10X, GEMT20P, GEMT20S, GEMT20T, GEMT20X, GEMT21P, GEMT21S, GEMT21T, GEMT21X, GEMT40P, GEMT40S, GEMT40T, GEMT40X, GEVT10P, GEVT10S, GEVT10T, GEVT10X, GEVT20P, GEVT20S, GEVT20T...(Other models you can see in the webshop)

<b>spare parts for</b>	500658
------------------------	--------

	<b>GEV No.</b>	511172	<b>Ref. No.</b>	50505890 70020050 LA70020050 LAR50505890 LAR70020050 R50505890 R70020050
shaft sealing ID ø 24mm ED ø 29mm thickness 3mm				

	<b>GEV No.</b>	551476	<b>Ref. No.</b>	—
--	----------------	--------	-----------------	---

<b>accessories for</b>	500658
------------------------	--------

	<b>GEV No.</b>	560449	<b>Ref. No.</b>	58004000 LA58004000 LAR58004000 R58004000
hexagonal screw thread M12x1.5 L thread L 22mm bore ø 6.3mm WS 19 total length 30mm				

	<b>GEV No.</b>	601244	<b>Ref. No.</b>	75400440 LA75400440 LAR75400440 R75400440
fan wheel D1 ø 350mm H1 114mm blades 12 D2 ø 19.5mm D3 ø 23mm H2 45mm				

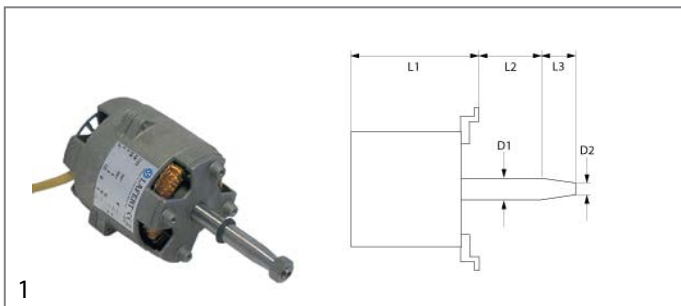

<b>GEV No.</b>	500139	<b>Ref. No.</b>	65040071+58004020 LAR65040071+LAR58004020 R65040071+R58004020
----------------	--------	-----------------	---

**description** fan motor 230V 1 phase 0.11kW speeds 1 L1 123mm L2 82mm

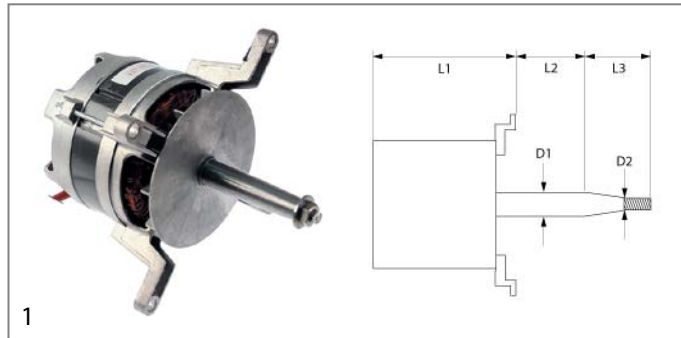

<b>GEV No.</b>	500659	<b>Ref. No.</b>	65040550 LAR65040550
----------------	--------	-----------------	-------------------------

**description** fan motor 230V 1 phase 50/60Hz 0.55kW 1400/1700rpm speeds 1 L1 150mm L2 52mm L3 45mm D1 ø 24mm D2 ø 20mm M12L IT 3A suitable capacitor 20µF/450V Cos(φ) 0.9 at 50Hz 1400rpm at 60Hz 1700rpm type 3042A2350

**For models:** ACG10M, AVG10D, AVG20D, CG100M, CG200M, GGMT10P, GGMT20P, GGMT20S, GGMT21P, GGMT21S, GGMT40P, GGMT40S, GGVT10P, GGVT10S, GGVT20P, GGVT20S, GGVT21P, GGVT21S, GGVT40P, GGVT40S, GMT20D, GVT20D, HMG101P, HMG102P, HMG201P, HMG202P, HVG101P, HVG102P, HVG201P, HVG202P, KMG072S, KMG101S, KMG102S, KMG201S, KMG202S, KMG202S, KMG202S, LBG5072, LBG5101, LBG5102, LBG5201, LBG5202, LVGS072, LVGS101, LVGS102, LVGS201, LVGS202, MACG10M, MACG20M, MCG101M, MCG102M...(Other models you can see in the webshop)

<b>spare parts for</b>	500659
------------------------	--------

	<b>GEV No.</b>	511172	<b>Ref. No.</b>	50505890 70020050 LA70020050 LAR50505890 LAR70020050 R50505890 R70020050
shaft sealing ID ø 24mm ED ø 29mm thickness 3mm				

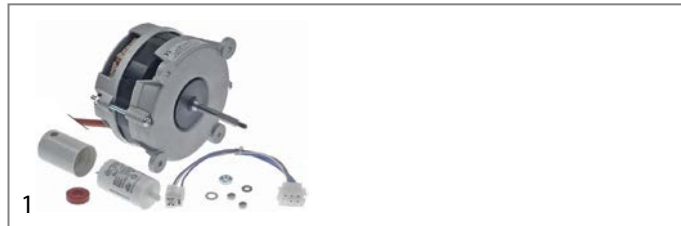

<b>GEV No.</b>	501565	<b>Ref. No.</b>	LAR65041040
----------------	--------	-----------------	-------------

**description** fan motor 230V 1 phase 50/60Hz 75W 2800rpm L1 85mm L2 57mm L3 12mm D1 ø 8mm D2 ø 5mm M5 0.6A suitable capacitor 5µF power input 125W Cos(φ) 0.96 type FIR no. 3013.2353

**For models:** CBEN061, CBES061, CEV026S, CEV026X, CEV061S, CEV061X, CEV101S, CEV101X, CME061S, CME061X, COEN026, COEN061, COEN101, COES026, COES061, COES101, CVE061S, CVE061X, CVEN061, CVES061, CVG061S, CVG061X, CVGN061, CVGS061, ICEM023, ICEM041, ICEM051, ICEM071, ICEM101, ICET023, ICET041, ICET051, ICET071, ICET101, ICGM051, ICGM071, ICGM101, ICGT051, ICGT071, ICGT101, KME061S, KME061X, KVE061S, KVE061X, KVG061X, REC051M, REC071M, REC101M, REP044M, REP044S...(Other models you can see in the webshop)







1

<b>GEV No.</b>	501564	<b>Ref. No.</b>	65060070 A34300760 LAR65060070
<b>description</b>	fan motor 230V 1 phase 50Hz 0.09kW 2500rpm L1 79mm L2 48mm L3 12mm D1 ø 5mm D2 ø 8mm M5 0.75A suitable capacitor 3.5µF Cos(fi) 0.98 type FIR no. 3012.2352		



1

<b>GEV No.</b>	500657	<b>Ref. No.</b>	65040540 LAR65040540
<b>description</b>	fan motor 230V 1 phase 50Hz 0.15/0.55kW 900/1400rpm speeds 2 L1 150mm L2 45mm L3 47mm D1 ø 24mm D2 ø 20mm M12L IT 1.3/3.0A suitable capacitor 20/10µF Cos(fi) 0.98 at 50Hz 900/1400rpm at 60Hz 1100/1700rpm 4P/6P type LM/FB 100L no. 472986		
<b>For models:</b>	ABG064M, ABG074M, ABG156S, APG08M, APG10M, ARG5084, ARG5154, BPG084M, BPG084P, BPG104M, BPG104P, GMT20P, MG101P, MG101T, MG102P, MG102T, MG201P, MG201T, MG202P, MG202T, MGMT40P, MGVT40P, PG084, PG104M, SMG101S, SVG101S, VG101P, VG201P, VG202P		
<b>spare parts for</b>	500657		
	<b>GEV No.</b>	511172	<b>Ref. No.</b> 50505890 70020050 LA70020050 LAR50505890 LAR70020050 R50505890 R70020050
shaft sealing ID ø 24mm ED ø 29mm thickness 3mm			



1

<b>GEV No.</b>	500663	<b>Ref. No.</b>	65040421 LAR65040421
<b>description</b>	fan motor 230V 1 phase 50Hz 0.18kW 0.25HP 2800rpm speeds 1 L1 123mm L2 77mm L3 30mm D1 ø 15mm D2 ø 12mm M10L ET 1.6A suitable capacitor 10µF/400V Cos(fi) 0.95 at 50Hz 2800rpm type 1057C2401		
<b>For models:</b>	AME07D, AVE07D, CE071M, CG071M, EMT06D, EVT06D, GEMT06P, GEVT06P, GEVT06S, GGMT06P, GGVT06P, GMT06D, GVT06D, HME061P, HMG061P, HVE061P, HVG061P, MACE07M, MACG07M, MCE071M, MCG071M, ME061D, ME061H, ME061M, MEMENT06D, MEVT06D, MG061D, MG061H, MG061M, MGMT06D, MGVT06D, MME071P, MMG071P, MVE071M, MVE071P, MVG071P, SCE071M, SIE071P, SME071S, SVE071P, SVE071S, VE061D, VE061M, VG061D, VG061M, XAME07D		



1

<b>GEV No.</b>	500643	<b>Ref. No.</b>	6034348
<b>description</b>	fan motor 230V 1 phase 50Hz 0.25/0.75kW 670/1370rpm speeds 2 L1 195mm L2 47mm L3 70mm D1 ø 24mm D2 ø 20mm M6R IT 1.5/4.7A suitable capacitor 50/20µF Cos(fi) 0.53/0.7 at 50Hz 670/1370rpm 4P/8P type FB100L no. 677325		
<b>For models:</b>	VE102MX		

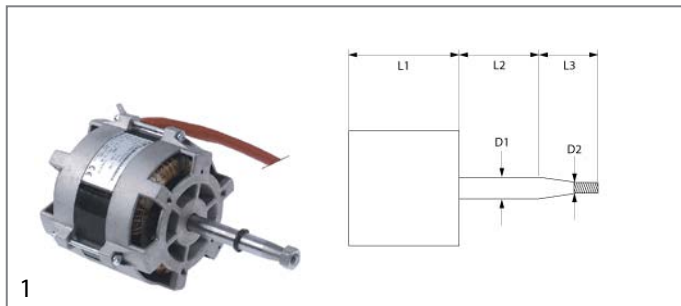

1			
<b>GEV No.</b>	500680	<b>Ref. No.</b>	65040420 LAR65040420
<b>description</b>	fan motor 230V 1 phase 50Hz 0.37kW 2800rpm speeds 1 L1 121mm L2 77mm L3 31mm D1 ø 16mm D2 ø 11mm 2.5A Cos(fi) 0.95 at 50Hz 230V at 50Hz 2800rpm type 1057.2155		
<b>For models:</b>	CE106M, CG106M, EC106M, EM006M+SC, EM106M, EM106M+SC, EV006M, EV106M, EV106M+SC, FE051M, FG051M, GC106M, GEMT07S, GEVT07S, GGMT07S, GGV07S, GM106M, GM106M+SC, GV006M, GV106M, GV106M+SC, KME081S, KMG081S, KVE081S, KVG081S, LBES071, LBG071, LVE071, LVGS071, ME106D, ME106M, ME106X, MG106D, MG106M, MG106X, PE041M, PE051M, PG041M, SAE071, SAEV071, SAGB071, SAGV071, VE106D, VE106M, VE106X, VG106D, VG106M, VG106X		
<b>accessories for</b>	500680		
	<b>GEV No.</b>	601060	<b>Ref. No.</b> 50405730 75400120 75400130 LA75400130 LAR50405730 LAR75400120 LAR75400130 R50405730 R75400120 R75400130
fan wheel D1 ø 180mm H1 60mm blades 16 D2 ø 11mm D3 ø 16mm H2 30mm			

1			
	<b>GEV No.</b>	501566	<b>Ref. No.</b> 65040600 LAR65040600
<b>description</b>	fan motor 230V 3 phase 50Hz 0.25kW 2700rpm L1 122mm L2 77mm L3 30mm D1 ø 15mm D2 ø 8mm M10 1.5A type FIR no. 1057.2650		
<b>For models:</b>	AREN064, ARGN064, GEMT06T, GEMT07X, GEVT06T, GEVT07X, GGMT06T, GGMT07X, GGV06T, GGV07X, HME061T, HME061X, HM-G061T, HMG061X, HVE061T, HVE061X, HVG061T, HVG061X, KME081X, KMG081X, KVE081X, KVG081X, LBET071, LBGT071, LVET071, LVGT071, NAE071, NAE071R, NAEV071, NAEV071R, NAGB071, NAGB071R, NAGV071, NAGV071R, SAE071R, SAEV071R, SAGB071R, SAGV071R		

1			
	<b>GEV No.</b>	602150	<b>Ref. No.</b> LA75400550
<b>description</b>	fan wheel blades 12 D1 ø 325mm D2 ø 19.5mm D3 ø 23mm H1 130mm H2 42mm H3 87mm		
<b>For models:</b>	KMG072S, KMG072X, KVG072X, LBG072, LBGT072, LVGS072, LVGT072, NAGB072, NAGB072R, NAGV072, NAGV072R, SAGB072, SAGB072R, SAGV072, SAGV072R		

1			
	<b>GEV No.</b>	602148	<b>Ref. No.</b> 75400470 75400471 LA75400471 LAR75400470 LAR75400471
<b>description</b>	fan wheel blades 12 D1 ø 350mm D2 ø 19.5mm D3 ø 23mm H1 118mm H2 50mm		
<b>For models:</b>	ABE084S, ABE104S, ABE156X, ABG084X, ABG104X, ABG156S, ARES084, ARES154, ARG084, ARG154, BPE084M, BPE084P, BPE104M, BPE104P, BPG084M, BPG084P, BPG104M, BPG104P, EVEA20S, GEMT10P, GEMT10S, GEMT20S, GEMT21P, GEMT21S, GEMT40S, GEVT10P, GEVT10S, GEVT20S, GEVT21P, GEVT21S, GEVT40S, GGMT10P, GGMT10S, GGMT20P, GGMT20S, GGMT21P, GGMT21S, GGMT40P, GGMT40S, GGVT10P, GGVT10S, GGVT20P, GGVT20S, GGVT21P, GGVT21S, GGVT40P, GGVT40S, HME101P, HME101S, HME102P..(Other models you can see in the webshop)		

1			
	<b>GEV No.</b>	602146	<b>Ref. No.</b> 75400490 LA75400490 LAR75400490
<b>description</b>	fan wheel blades 8 D1 ø 220mm D2 ø 11mm D3 ø 16mm H1 83mm H2 25mm		
<b>For models:</b>	MVE071M, SCE071M, SME071S, SVE071P, SVE071S		

			
1			
<b>GEV No.</b>	601067	<b>Ref. No.</b>	50405781 75400030 75400040 LAR50405781 LAR75400030 LAR75400040
<b>description</b>	fan wheel D1 ø 150mm H1 38mm blades 36 D2 ø 6mm D3 ø 6mm H2 14mm		
<b>For models:</b>	CVE004H, CVE004M, CVE104H, CVE104M, ME004L, ME004S, ME104L, ME104S, VE004D, VE004H, VE004M, VE004S, VE004X, VE104D, VE104H, VE104M, VE104S, VE104X		

			
1			
<b>GEV No.</b>	601068	<b>Ref. No.</b>	50405795 75400080 75400090 LAR50405795 LAR75400080 LAR75400090
<b>description</b>	fan wheel D1 ø 160mm H1 70mm blades 16 D2 ø 12mm D3 ø 16mm H2 29mm		
<b>For models:</b>	CG105M, CVE105H, CVE105M, CVG105H, CVG105M, ME105L, ME105S, MG105L, MG105S, VE105D, VE105H, VE105M, VE105NS, VE105S, VE105X, VE155H, VE155M, VE155X, VG105D, VG105H, VG105M, VG105S, VG105X		

			
1			
<b>GEV No.</b>	601353	<b>Ref. No.</b>	75400510 LA75400510 LAR75400510
<b>description</b>	fan wheel D1 ø 150mm H1 50mm blades 36 D2 ø 8mm D3 ø 6/8mm H2 26mm		
<b>For models:</b>	ACE04M, CE041M, CVE024S, CVE024X, MACE04M, MCE042M, MVE042P, SVE042S, VE042P		

			
1			
<b>GEV No.</b>	601060	<b>Ref. No.</b>	50405730 75400120 75400130 LA75400130 LAR50405730 LAR75400120 LAR75400130
<b>description</b>	fan wheel D1 ø 180mm H1 60mm blades 16 D2 ø 11mm D3 ø 16mm H2 30mm		
<b>For models:</b>	FE051M, FE051X, FE105M, FE105X, FG051M, FG051X, FG105M, FG105X, ME05, MG05, MME05, PE04, PE040M, PE040X, PE041M, PE041X, PE051M, PE051X, PG04, PG040M, PG040X, PG041M, PG041X, PG051M, PG051X, RE05, RG05		

			
1			
<b>GEV No.</b>	601061	<b>Ref. No.</b>	50405740 75400060 LA75400060 LAR50405740 LAR75400060
<b>description</b>	fan wheel D1 ø 160mm H1 60mm blades 15 D2 ø 18mm D3 ø 18mm H2 35mm		
<b>For models:</b>	FE05, FG05		



			
1			
<b>GEV No.</b>	601246	<b>Ref. No.</b>	34300730 75400410 LA75400410 LAR75400410
<b>description</b>	fan wheel D1 ø 180mm H1 77mm blades 12 D2 ø 8mm D3 ø 6mm H2 25.5mm		
<b>For models:</b>	A05PES, A05PES+UM, A05RES, A05RES+UM, A08PES, A08PES+UM, A08RES, A08RES+UM, A10PES, A10PES+UM, A10RES, A10RES+UM, ABE044M, ABE054M, ACE05M, AVG05P, BPE044M, BPE044P, BPE054M, BPE054P, BPG044M, BPG044P, BPG054M, BPG054P, CBEN061, CBES061, CE051M, CG051M, CME061S, CME061X, CVE061S, CVE061X, CVEN061, CVES061, CVG061S, CVG061X, CVGN061, CVGS061, ICEM023, ICEM041, ICEM051, ICEM071, ICEM101, ICET023, ICET041, ICET051, ICET071, ICET101, ICGM051, ICGM071...(Other models you can see in the webshop)		

			
1			
<b>GEV No.</b>	601064	<b>Ref. No.</b>	50405812 75400210 75400230 LA75400230 LAR50405812 LAR75400210 LAR75400230
<b>description</b>	fan wheel D1 ø 220mm H1 78mm blades 20 D2 ø 11.5mm D3 ø 16.5mm H2 30mm		
<b>For models:</b>	FME61A, FME61S, ME106D, ME106H, ME106L, ME106M, ME106P, ME106S, ME106T, ME106X, MG106D, MG106H, MG106L, MG106M, MG106P, MG106S, MG106T, MG106X, VE106D, VE106H, VE106L, VE106M, VE106P, VE106S, VE106T, VE106X, VG106D, VG106H, VG106L, VG106M, VG106P, VG106S, VG106T, VG106X		

			
2			
<b>GEV No.</b>	601243	<b>Ref. No.</b>	75400400 LA75400400 LAR75400400
<b>description</b>	fan wheel D1 ø 220mm H1 78mm blades 12 D2 ø 11mm D3 ø 16mm H2 29mm		
<b>For models:</b>	AME07D, AME07P, APE06, APE07, AVE07D, AVE07P, BPE064M, BPE064P, BPE074M, BPE074P, BPG064M, BPG064P, BPG074M, BPG074P, CE071M, CE106M, CG071M, CG106M, EC106M, EM006H, EM006M+SC, EM106H, EM106M, EM106M+SC, EM106P, EMT06D, EV006M, EV006P, EV106H, EV106M, EV106M+SC, EV106P, EVT06D, EVT06P, GC106M, GEMT06P, GEMT06T, GEMT10P, GEMT10T, GEMT21P, GEMT21T, GEVT06P, GEVT06S, GEVT06T, GEVT10P, GEVT10T, GEVT21P, GEVT21T, GGMT06P, GGMT06T...(Other models you can see in the webshop)		

			
1			
<b>GEV No.</b>	602145	<b>Ref. No.</b>	LA75400570K_081
<b>description</b>	fan wheel D1 ø 240mm D2 ø 11mm SS D3 ø 16mm H1 83mm blades 6		

			
1			
<b>GEV No.</b>	601062	<b>Ref. No.</b>	50405720 75400240 LAR50405720 LAR75400240
<b>description</b>	fan wheel D1 ø 270mm H1 100mm blades 24 D2 ø 19.5mm D3 ø 23mm H2 46mm		
<b>For models:</b>	ME15, ME21, MG15, MG21, PE12, PG12, RE07, RG07		



1

<b>GEV No.</b>	601065	<b>Ref. No.</b>	50405820 75400270 75400290 LA75400290 LAR50405820 LAR75400270 LAR75400290
<b>description</b>	fan wheel D1 ø 300mm H1 120mm blades 20 D2 ø 19.5mm D3 ø 23mm H2 46mm		
<b>For models:</b>	CE110M, CG110M, EC110M, EM010H, EM010M+SC, EM110H, EM110M, EM110M+SC, EM110P, EV010H, EV010M, EV010P, EV110H, EV110M, EV110M+SC, EV110P, FME101AX, FME201SX, FMG201A, FMG201S, GC010M, GC110M, GM110H, GM110M, GM110M+SC, GM110P, GV010H, GV010M, GV110H, GV110M, GV110M+SC, GV110P, ME110D, ME110H, ME110L, ME110M, ME110P, ME110S, ME110T, ME110X, ME120D, ME120H, ME120L, ME120M, ME120P, ME120S, ME120T, ME120X, MEC20H, MEC20P...(Other models you can see in the webshop)		



1

<b>GEV No.</b>	601244	<b>Ref. No.</b>	75400440 LA75400440 LAR75400440
<b>description</b>	fan wheel D1 ø 350mm H1 114mm blades 12 D2 ø 19.5mm D3 ø 23mm H2 45mm		
<b>For models:</b>	ABE084S, ABE104S, ABE156X, ABG084X, ABG104X, ABG156S, ACE10M, ACG10M, AME10D, APG08M, APG10M, AREN084, AREN154, ARES084, ARES154, ARGN084, ARGN154, ARGS084, ARGS154, AVE10D, AVE10P, AVG10D, AVG20D, BPE084M, BPE084P, BPE104M, BPE104P, BPG084M, BPG084P, BPG104M, BPG104P, CE100M, CE200M, CG100M, CG200M, CKES10, EMT10D, EMT20P, EMT21P, EPE086T, EPE156T, EPEV08T, EPEV15T, EPG086T, EPG156T, EPGV08T, EPGV15T, EVEA20S, EVT10P, EVT20D...(Other models you can see in the webshop)		



1

<b>GEV No.</b>	601063	<b>Ref. No.</b>	50405710 75400330 LAR50405710 LAR75400330
<b>description</b>	fan wheel D1 ø 350mm H1 100mm blades 24 D2 ø 19.5mm D3 ø 23mm H2 46mm		
<b>For models:</b>	ME10, ME20, ME24, ME40, MG10, MG20, MG24, MG40, MME10, MME40, PE08, PG08, RE10, RE20, RE24, RG10, RG20, RG24, RG40		



1

<b>GEV No.</b>	601066	<b>Ref. No.</b>	75400360 75400380 LAR75400360 LAR75400380
<b>description</b>	fan wheel D1 ø 350mm H1 120mm blades 24 D2 ø 19.5mm D3 ø 23.5mm H2 45mm		
<b>For models:</b>	CE210M, CEC40M, CES24M, CES40M, CG210M, CGC24M, CGC40M, CGS24M, CGS40M, EC020M, EC210M, EM020M, EM210H, EM210M, EM210M+SC, EM210P, EV020M, EV210H, EV210M, EV210M+SC, EV210P, FEI102P, GC020M, GC210M, GM020H, GM020M, GM210H, GM210M, GM210M+SC, GM210P, GV020H, GV210H, GV210M, GV210M+SC, GV210P, ME210D, ME210H, ME210L, ME210M, ME210P, ME210S, ME210T, ME210X, ME220D, ME220H, ME220L, ME220M, ME220P, ME220S, ME220T...(Other models you can see in the webshop)		



1

<b>GEV No.</b>	601204	<b>Ref. No.</b>	5901022
<b>description</b>	fan wheel D1 ø 350mm H1 135mm blades 30 D2 ø 19.5mm D3 ø 23mm H2 46mm		
<b>For models:</b>	VE102MX		





			
1			
<b>GEV No.</b>	550855	<b>Ref. No.</b>	58005510 LAR58005510
<b>description</b>	flange for fan motor ED ø 35mm int. ø 1 22mm int. ø 2 8mm thickness 8mm brass		
<b>For models:</b>	CVE004H, CVE004M, CVE104H, CVE104M, VE004D, VE004H, VE004M, VE004X, VE104D, VE104H, VE104M, VE104X		

			
1			
<b>GEV No.</b>	550856	<b>Ref. No.</b>	58003860 LAR58003860
<b>description</b>	flange for fan motor ED ø 50mm int. ø 1 19.5mm int. ø 2 16mm thickness 3mm brass		
<b>For models:</b>	AME07D, AME07P, APE06, APE07, AREN064, ARES064, ARGN064, ARG064, AVE07D, AVE07P, BPE064M, BPE064P, BPE074M, BPE074P, BPG064M, BPG064P, BPG074M, BPG074P, CE071M, CE106M, CG071M, CG105M, CG106M, CVE105H, CVE105M, CVG105H, CVG105M, EC106M, EM006H, EM006M+SC, EM106H, EM106M, EM106M+SC, EM106P, EMT06D, EV006M, EV006P, EV106H, EV106M, EV106M+SC, EV106P, EVT06D, EVT06P, FE051M, FE051X, FE105M, FE105X, FG051M, FG051X, FG105M...(Other models you can see in the webshop)		

			
1			
<b>GEV No.</b>	550858	<b>Ref. No.</b>	58003840 LAR58003840
<b>description</b>	flange for fan motor ED ø 60mm int. ø 1 28.5mm int. ø 2 25mm thickness 4mm brass		
<b>For models:</b>	ABE084S, ABE104S, ABE156X, ABG064M, ABG074M, ABG084X, ABG104X, ABG156S, ACE10M, ACG10M, AME10D, APG08M, APG10M, AREN084, AREN154, ARES084, ARES154, ARGN084, ARGN154, ARG084, ARG154, AVE10D, AVE10P, AVG10D, AVG20D, BPE084M, BPE084P, BPE104M, BPE104P, BPG084M, BPG084P, BPG104M, BPG104P, CE100M, CE110M, CE200M, CE210M, CEC40M, CES24M, CES40M, CG100M, CG110M, CG200M, CG210M, CGC24M, CGC40M, CGS24M, CGS40M, CKES10, ECO20M...(Other models you can see in the webshop)		

			
1			
<b>GEV No.</b>	550860	<b>Ref. No.</b>	58005500 LAR58005500
<b>description</b>	flange for gasket ED ø 35mm int. ø 1 22mm int. ø 2 9mm thickness 8mm brass		
<b>For models:</b>	ABE044M, ABE054M, ACE04M, ACE05M, AVG05P, BPE044M, BPE044P, BPE054M, BPE054P, BPG044M, BPG044P, BPG054M, BPG054P, CBEN061, CBES061, CE041M, CE051M, CEV026S, CEV026X, CEV061S, CEV061X, CEV101S, CEV101X, CG051M, CME061S, CME061X, COEN026, COEN061, COEN101, COES026, COES061, COES101, CVE024S, CVE024X, CVE061S, CVE061X, CVEN061, CVES061, CVG061S, CVG061X, CVGN061, CVGS061, ICEM023, ICEM041, ICEM051, ICEM071, ICEM101, ICET023, ICET041, ICET051...(Other models you can see in the webshop)		

			
1			
<b>GEV No.</b>	560449	<b>Ref. No.</b>	58004000 LA58004000 LAR58004000
<b>description</b>	hexagonal screw thread M12x1.5 L thread L 22mm bore ø 6.3mm WS 19 total length 30mm		
<b>For models:</b>	ABE084S, ABE104S, ABE156X, ABG064M, ABG074M, ABG084X, ABG104X, ABG156S, ACE10M, ACG10M, AME10D, APG08M, APG10M, AREN064, AREN084, AREN154, ARES064, ARES084, ARES154, ARGN064, ARGN084, ARGN154, ARG064, ARG084, ARG154, AVE10D, AVE10P, AVG10D, AVG20D, BPE084M, BPE084P, BPE104M, BPE104P, BPG084M, BPG084P, BPG104M, BPG104P, CE100M, CE110M, CE200M, CE210M, CEC40M, CES24M, CES40M, CG100M, CG110M, CG200M, CG210M, CGC24M, CGC40M...(Other models you can see in the webshop)		

			
1			
<b>GEV No.</b>	500639	<b>Ref. No.</b>	65040101 65490710 LAR65040101 LAR65490710
<b>description</b>	motor kit 220/240V 1 phase 50/60Hz 0.25kW type K48210		
<b>For models:</b>	CVE004H, CVE004M, CVE104H, CVE104M, VE004D, VE004H, VE004M, VE004X, VE104D, VE104H, VE104M, VE104X		
<b>spare parts for</b>	500639		

			
<b>GEV No.</b>	511170	<b>Ref. No.</b>	50505895 70020010 LAR50505895 LAR70020010 R50505895 R70020010
<b>description</b>	shaft seal ID ø 7mm ED ø 22mm thickness 7mm		

			
<b>GEV No.</b>	550855	<b>Ref. No.</b>	58005510 LAR58005510 R58005510
<b>description</b>	flange for fan motor ED ø 35mm int. ø 1 22mm int. ø 2 8mm thickness 8mm brass		

			
<b>GEV No.</b>	601067	<b>Ref. No.</b>	50405781 75400030 75400040 LAR50405781 LAR75400030 LAR75400040 R50405781 R75400030 R75400040
<b>description</b>	fan wheel D1 ø 150mm H1 38mm blades 36 D2 ø 6mm D3 ø 6mm H2 14mm		

			
<b>GEV No.</b>	601856	<b>Ref. No.</b>	65041010 LAR65041010 R65041010
<b>description</b>	fan motor 220-240V 1 phase 50/60Hz 0.075kW 2800/3200rpm speeds 1 L1 85mm L2 30mm L3 23mm L4 12mm D1 ø 8x6mm D2 ø 8mm 0.6A suitable capacitor 5µF/400V		



			
1			
<b>GEV No.</b>	550861	<b>Ref. No.</b>	70020020 LA70020020 LAR70020020
<b>description</b>	shaft seal for fan motor ID $\phi$ 7.5mm ED $\phi$ 22mm thickness 7mm		
<b>For models:</b>	ABE044M, ABE054M, ACE04M, ACE05M, AVG05P, BPE044M, BPE044P, BPE054M, BPE054P, BPG044M, BPG044P, BPG054M, BPG054P, CBEN061, CBES061, CE041M, CE051M, CEV026S, CEV026X, CEV061S, CEV061X, CEV101S, CEV101X, CG051M, CME061S, CME061X, COEN026, COEN061, COEN101, COES026, COES061, COES101, CVE024S, CVE024X, CVE061S, CVE061X, CVEN061, CVES061, CVG061S, CVG061X, CVGN061, CVGS061, ICEM023, ICEM041, ICEM051, ICEM071, ICEM101, ICET023, ICET041, ICET051...(Other models you can see in the webshop)		

			
1			
<b>GEV No.</b>	511171	<b>Ref. No.</b>	50505880 70020040 LA70020040 LAR50505880 LAR70020040
<b>description</b>	shaft seal ID $\phi$ 14.5mm ED $\phi$ 20mm thickness 3mm		
<b>For models:</b>	AME07D, AME07P, APE06, APE07, AREN064, ARES064, ARGN064, ARGS064, AVE07D, AVE07P, BPE064M, BPE064P, BPE074M, BPE074P, BPG064M, BPG064P, BPG074M, BPG074P, CE071M, CE106M, CG071M, CG105M, CG106M, CVE105H, CVE105M, CVG105H, CVG105M, EC106M, EM006H, EM006M+SC, EM106H, EM106M, EM106M+SC, EM106P, EMT06D, EPE056T, EPEV05T, EPG056T, EPGV05T, EV006M, EV006P, EV106H, EV106M, EV106M+SC, EV106P, EVT06D, EVT06P, FE051M, FE051X, FE105M...(Other models you can see in the webshop)		

			
1			
<b>GEV No.</b>	511170	<b>Ref. No.</b>	50505895 70020010 LAR50505895 LAR70020010
<b>description</b>	shaft seal ID $\phi$ 7mm ED $\phi$ 22mm thickness 7mm		
<b>For models:</b>	CVE004H, CVE004M, CVE104H, CVE104M, ME004L, ME004S, ME104L, ME104S, VE004D, VE004H, VE004M, VE004S, VE004X, VE104D, VE104H, VE104M, VE104S, VE104X		

			
1			
<b>GEV No.</b>	511172	<b>Ref. No.</b>	50505890 70020050 LA70020050 LAR50505890 LAR70020050
<b>description</b>	shaft sealing ID $\phi$ 24mm ED $\phi$ 29mm thickness 3mm		
<b>For models:</b>	ABE084S, ABE104S, ABE156X, ABG064M, ABG074M, ABG084X, ABG104X, ABG156S, ACE10M, ACG10M, AME10D, APG08M, APG10M, AREN084, AREN154, ARES084, ARES154, ARGN084, ARGN154, ARGS084, ARGS154, AVE10D, AVE10P, AVG10D, AVG20D, BPE084M, BPE084P, BPE104M, BPE104P, BPG084M, BPG084P, BPG104M, BPG104P, CE100M, CE110M, CE200M, CE210M, CEC40M, CES24M, CES40M, CG100M, CG110M, CG200M, CG210M, CGC24M, CGC40M, CGS24M, CGS40M, CKES10, EC020M...(Other models you can see in the webshop)		



hot air fans

miscellaneous

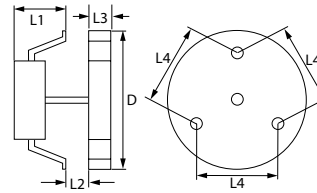

1



<b>GEV No.</b>	601054	<b>Ref. No.</b>	65060040 650600400 LAR650600400 MA1037117200
<b>description</b>	hot air fan 220-240V 32W 50/60Hz L1 60mm L2 10mm L3 25mm L4 87mm fan wheel $\phi$ 150mm FIME type C20X0E01/46		
<b>For models:</b>	VE210L, VE210S		
<b>spare parts for</b>	601054		
	<b>GEV No.</b>	601441	<b>Ref. No.</b> —
fan wheel $\phi$ 150mm W 25mm shaft intake $\phi$ 6x5mm stainless steel blades 7			
<b>accessories for</b>	601054		
	<b>GEV No.</b>	550879	<b>Ref. No.</b> —
insulation $\phi$ 130mm thickness 3mm hole $\phi$ 18mm for hot air fan			



1

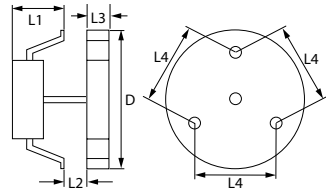

<b>GEV No.</b>	601175	<b>Ref. No.</b>	34300420 65060030 A34300420 LA65060030 LAR65060030
<b>description</b>	hot air fan 230V 47W 50/60Hz L1 73mm L2 28mm L3 29mm L4 87mm fan wheel ø 154mm FIME type C30X0L13/05CLH		
<b>For models:</b>	REC023M		

accessories

miscellaneous



1

<b>GEV No.</b>	701623	<b>Ref. No.</b>	75300150 LA753001750 LAR75300150
<b>description</b>	guard ø 170mm hole ø 7mm for hot air fan combi-steamer		
<b>For models:</b>	A05PES, A05PES+UM, A05RES, A05RES+UM, A08PES, A08PES+UM, A08RES, A08RES+UM, A10PES, A10PES+UM, A10RES, A10RES+UM, CME061X, CVE061S, KVE061S, REC051M, REC071M, REP044S, REP054M, REP054S, REV051M, REV051S, REV071M, REV071S, REV101M, REV101S, RGC101M		



1

<b>GEV No.</b>	551434	<b>Ref. No.</b>	58004010 LA58004010 LAR58004010
<b>description</b>	plain washer ø 30mm thickness 3mm hole ø 12.5mm for fan wheel combi-steamer		
<b>For models:</b>	ABE084S, ABE104S, ABE156X, ABG084X, ABG104X, ABG156S, ACE10M, ACG10M, AME10D, APG08M, APG10M, AREN064, AREN084, AREN154, ARES064, ARES084, ARES154, ARGN064, ARGN084, ARGN154, ARGS064, ARGS084, ARGS154, AVE10D, AVE10P, AVG10D, AVG20D, BPE084M, BPE084P, BPE104M, BPE104P, BPG084M, BPG084P, BPG104M, BPG104P, CE100M, CE110M, CE200M, CE210M, CEC40M, CES24M, CES40M, CG100M, CG110M, CG200M, CG210M, CGC24M, CGC40M, CGS24M, CGS40M...(Other models you can see in the webshop)		

radial fans



1



<b>GEV No.</b>	601181	<b>Ref. No.</b>	65060360 LA65060360 LAR65060360
<b>description</b>	radial fan 230V voltage AC 50Hz 100W H1 170mm L1 175mm D1 ø 50mm W1 115mm W2 40mm H2 45mm		
<b>For models:</b>	ABG064M, ABG074M, ABG084X, ABG104X, ABG156S, ARGN064, ARGN084, ARGN154, ARGS064, ARGS084, ARGS154, BPG044M, BPG044P, BPG054M, BPG054P, BPG064M, BPG064P, BPG074M, BPG074P, BPG084M, BPG084P, BPG104M, BPG104P, CVG061S, CVG061X, EPG056T, EPG086T, EPG156T, EPGV05T, EPGV08T, EPGV15T, GGMT06P, GGMT06T, GGMT07S, GGMT07X, GGMT10P, GGMT10S, GGMT10T, GGMT10X, GGMT20P, GGMT20S, GGMT20T, GGMT20X, GGMT21P, GGMT21S, GGMT21X, GGMT40P, GGMT40S, GGMT40T...(Other models you can see in the webshop)		

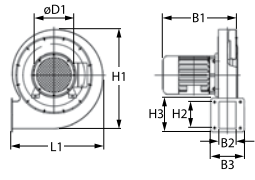

1

Image not available

<b>GEV No.</b>	601245	<b>Ref. No.</b>	63130010 LA63130010 LAR63130010
<b>description</b>	radial fan 24V voltage DC 50Hz 45W H1 170mm L1 170mm D1 ø 50mm W1 90mm W2 44mm H2 57mm W3 83mm H3 83mm		
<b>For models:</b>	ACG10M, APG08M, APG10M, AVG05P, AVG10D, AVG20D, CG051M, CG071M, CG100M, CG200M, GMT06D, GMT06P, GMT20D, GMT20P, GVT06D, GVT06P, GVT20D, MACG05M, MACG07M, MACG10M, MACG20M, MG061D, MG061H, MG061M, MG061P, MG061T, MG101D, MG101H, MG101M, MG101P, MG101T, MG102D, MG102H, MG102M, MG102P, MG102T, MG201D, MG201H, MG201M, MG201P, MG201T, MG202D, MG202H, MG202M, MG202P, MG202T, MGMT06D, MGMT06P, MGMT10D, MGMT10P...(Other models you can see in the webshop)		
<b>accessories for</b>	601245		
<b>GEV No.</b>	104309	<b>Ref. No.</b>	63140020 LAR63140020 R63140020
<b>description</b>	gasket L 106mm W 100mm H 3mm 4 holes		

accessories universal



1

<b>GEV No.</b>	801445	<b>Ref. No.</b>	R75401230
<b>description</b>	puller for fan wheel seat ø 33-40mm WS 24		



## motors

## gear motors

for combi-steamers



1

<b>GEV No.</b>	502288	<b>Ref. No.</b>	65090250 LAR65090250
<b>description</b>	gear kit 8W 230V voltage AC 30rpm shaft ø 6mm L 75mm W 87mm H 84mm conversion kit		
<b>For models:</b>	ABE084S, ABE104S, ABE156X, ABG084X, ABG104X, ABG156S, AREN154, ARES154, ARGN154, ARG5154, CEV026S, CEV026X, CEV061S, CEV061X, CEV101S, CEV101X, CKES10, CME061S, CME061X, CVE024S, CVE024X, CVE061S, CVE061X, CVG061S, CVG061X, EVEA20S, GEVT06S, GEVT20X, KME061S, KME061X, KME081S, KME081X, KME101S, KME101X, KMEA20S, KMEA20X, KMG081S, KMG081X, KMG101S, KMG101X, KMG20S, KMG20X, KVE061S, KVE061X, KVE081S, KVE081X, KVE101S, KVE101X, KVEA20S, KVEA20X...(Other models you can see in the webshop)		
<b>spare parts for</b>	502288		
	<b>GEV No.</b>	502291	<b>Ref. No.</b> 65090260 LA65090260 R65090260
	gear motor METEOR type 58U59DB4A1/00 8W 230V voltage AC 50Hz 30rpm shaft ø 6x5mm L 69mm W 49mm H 65mm		



1

<b>GEV No.</b>	502291	<b>Ref. No.</b>	65090260 LA65090260 R65090260
<b>description</b>	gear motor METEOR type 58U59DB4A1/00 8W 230V voltage AC 50Hz 30rpm shaft ø 6x5mm L 69mm W 49mm H 65mm		
<b>For models:</b>	AREN064, AREN084, ARES064, ARES084, ARGN064, ARGN084, ARGS064, ARGS084, CBEN061, CBES061, COEN026, COEN061, COEN101, COES026, COES061, COES101, CVEN061, CVES061, CVGN061, CVGS061, GEMT07S, GEMT07X, GEMT10S, GEMT10X, GEMT20S, GEMT20X, GEMT21S, GEMT21X, GEMT40S, GEMT40X, GEVT07S, GEVT07X, GEVT10S, GEVT10X, GEVT20S, GEVT20X, GEVT21S, GEVT21X, GEVT40S, GEVT40X, GGMT07S, GGMT07X, GGMT10S, GGMT10X, GGMT20S, GGMT20X, GGMT21S, GGMT21X, GGMT40S, GGMT40X...(Other models you can see in the webshop)		

## pumps

## drain pumps

miscellaneous



1

<b>GEV No.</b>	500201	<b>Ref. No.</b>	65110300 LA65110300 LAR65110300
<b>description</b>	drain pump inlet ø 24mm outlet ø 22mm 230V 34W		
<b>For models:</b>	AREN064, AREN084, ARES064, ARES084, ARGN064, ARGN084, ARGS064, ARGS084, GMT06D, NAEB071, NAEB071R, NAEB072R, NAEB101, NAEB101R, NAEB102, NAEB102R, NAEBO72, NAEV071, NAEV071R, NAEV072, NAEV072R, NAEV101, NAEV101R, NAEV102, NAEV102R, NAGB071, NAGB071R, NAGB072, NAGB072R, NAGB101, NAGB101R, NAGB102, NAGB102R, NAGV071, NAGV071R, NAGV072, NAGV072R, NAGV101, NAGV101R, NAGV102, NAGV102R, SAEB071, SAEB072, SAEB101, SAEB102, SAEV071, SAEV072, SAEV101, SAEV102, SAGB071...(Other models you can see in the webshop)		

## booster pumps II

accessories





1

<b>GEV No.</b>	365015	<b>Ref. No.</b>	65190180 LA65190180 LAR65190180
<b>description</b>	operating capacitor capacity 10µF 400V tolerance 5%Hz ambient temperature max. -25 to +85°C ø 35.5mm L 59mm M8 plastic connection male faston 6.3mm protection		
<b>For models:</b>	ABE044M, ABE054M, ABG064M, ABG074M, ACE04M, ACE05M, ACE10M, ACG10M, AME07D, AME07P, AME10D, APE06, APE07, APG08M, APG10M, ARES064, ARGS064, ARGS084, AVE07D, AVE07P, AVE10D, AVE10P, AVGO5P, AVGO10D, AVGO20D, BPE044M, BPE044P, BPE054M, BPE054P, BPG044M, BPG044P, BPG054M, BPG054P, BPG064M, BPG064P, BPG074M, BPG074P, CE041M, CE051M, CE071M, CE100M, CE106M, CE200M, CG051M, CG071M, CG100M, CG106M, CG200M, EC106M, EM006H...(Other models you can see in the webshop)		



vibration pumps



<b>GEV No.</b>	500568	<b>Ref. No.</b>	65110600 LAR65110600
<b>description</b>	vibration pump 230V 32W 50Hz inlet ø 7 outlet ø 1/8" IT CEME type E512/A32		
<b>For models:</b>	ABE084S, ABE104S, ABE156X, ABG084X, ABG104X, ABG156S, AREN064, AREN084, AREN154, ARES064, ARES084, ARES154, ARGN064, ARGN084, ARGN154, ARGS064, ARGS084, ARGS154, CBEN061, CBES061, CEV026S, CEV026X, CEV061S, CEV061X, CEV101S, CEV101X, CKES10, CME061S, CME061X, COEN026, COEN061, COEN101, COES026, COES061, COES101, CVE024S, CVE024X, CVE061S, CVE061X, CVEN061, CVES061, CVG061S, CVG061X, CVGN061, CVGS061, EMT20P, EMT21P, EPE056T, EPE086T, EPE156T... (Other models you can see in the webshop)		
<b>spare parts for</b>	500568		
	<b>GEV No.</b>	390698	<b>Ref. No.</b> —
	thermal fuse switch-off temp. 110°C suitable for ULKA pump		
	<b>GEV No.</b>	520153	<b>Ref. No.</b> —
	bracket rubber dimensions 53x34x28mm		



<b>GEV No.</b>	501567	<b>Ref. No.</b>	65110620 LAR65110620
<b>description</b>	vibration pump type HF 230V 22W 50Hz inlet ø 6 outlet ø 6 ULKA plastic L 97mm connection male faston 4.8mm		
<b>For models:</b>	CBEN061, CBES061, CME061S, CME061X, GEMT07S, GEMT07X, GEMT10S, GEMT10X, GEMT20S, GEMT20X, GEMT21S, GEMT21X, GEMT40S, GEMT40X, GGMT07S, GGMT07X, GGMT10S, GGMT10X, GGMT20S, GGMT20X, GGMT21S, GGMT21X, GGMT40S, GGMT40X, HME101S, HME102S, HME201S, HME202S, KME061S, KME061X, KME072S, KME072X, KME081S, KME081X, KME101S, KME101X, KME102X, KME201S, KME201X, KME202S, KME202X, KMEA20S, KMEA20X, KMG072S, KMG072X, KMG081S, KMG081X, KMG101S, KMG101X, KMG102S... (Other models you can see in the webshop)		



<b>GEV No.</b>	500563	<b>Ref. No.</b>	69200060 99600624 A34300430 LAR69200060 LAR99600624
<b>description</b>	vibration pump type NME Typ2 230V 16W 50Hz inlet ø 4 outlet ø 6 ULKA L 76mm 110cc/min		

condensators & interference suppression filters

operating capacitors

plastic



<b>GEV No.</b>	365015	<b>Ref. No.</b>	65190180 LA65190180 LAR65190180
<b>description</b>	operating capacitor capacity 10µF 400V tolerance 5%Hz ambient temperature max. -25 to +85°C ø 35.5mm L 59mm M8 plastic connection male faston 6.3mm protection		
<b>For models:</b>	ABE044M, ABE054M, ABG064M, ABG074M, ACE04M, ACE05M, ACE10M, ACG10M, AME07D, AME07P, AME10D, APE06, APE07, APG08M, APG10M, ARES064, ARGS064, ARGS084, AVE07D, AVE07P, AVE10D, AVE10P, AVG05P, AVG10D, AVG20D, BPE044M, BPE044P, BPE054M, BPE054P, BPG044M, BPG044P, BPG054M, BPG054P, BPG064M, BPG064P, BPG074M, BPG074P, CE041M, CE051M, CE071M, CE100M, CE106M, CE200M, CG051M, CG071M, CG100M, CG106M, CG200M, EC106M, EM006H... (Other models you can see in the webshop)		



<b>GEV No.</b>	365021	<b>Ref. No.</b>	65190030 LAR65190030
<b>description</b>	operating capacitor capacity 16µF 425V tolerance 5% 50/60Hz ambient temperature max. -25 to +85°C ø 35mm L 73mm single M8 plastic connection male faston 6.3mm 416.10.99 protection		
<b>For models:</b>	CG110M, CG210M, CGC24M, CGC40M, CGS24M, CGS40M, FMG201A, FMG201S, GC010M, GC020M, GC110M, GC210M, GM020H, GM020M, GM110H, GM110M, GM110M+SC, GM110P, GM210H, GM210M, GM210M+SC, GM210P, GMT20D, GMT20P, GV010H, GV010M, GV020H, GV110H, GV110M, GV110M+SC, GV110P, GV210H, GV210M, GV210M+SC, GV210P, GVT20D, MG102D, MG102H, MG102M, MG102P, MG102T, MG110D, MG110H, MG110L, MG110M, MG110P, MG110S, MG110T, MG110X, MG120D... (Other models you can see in the webshop)		

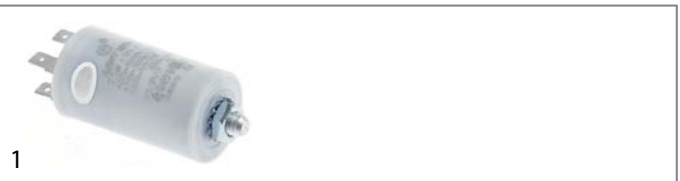



<b>GEV No.</b>	365009	<b>Ref. No.</b>	965315
<b>description</b>	operating capacitor capacity 2.5µF 400V tolerance 5% 50Hz ambient temperature max. -25 to +85°C ø 36.5mm L 55mm M8 plastic connection male faston 6.3mm 1.27.65C3 protection		





			
<b>1</b>			
<b>GEV No.</b>	365019	<b>Ref. No.</b>	50405630
<b>description</b>	operating capacitor capacity 20µF 400V tolerance 5% 50/60Hz ambient temperature max. -25 to +85°C ø 39.5mm L 70mm M8 plastic connection male faston 6.3mm 16.10.25. protection		

			
<b>1</b>			
<b>GEV No.</b>	365031	<b>Ref. No.</b>	50405600 65190010 LAR65190010 R50405600
<b>description</b>	operating capacitor capacity 4µF 450V tolerance 5% 50/60Hz ambient temperature max. -25 to +85°C ø 31mm L 58mm M8 plastic connection male faston 6.3mm protection		
<b>For models:</b>	FE05, FG05, ME004L, ME004S, ME104L, ME104S, ME105L, ME105S, MG105L, MG105S, VE004S, VE104S, VE105NS, VE105S, VG105S		

			
<b>1</b>			
<b>GEV No.</b>	365033	<b>Ref. No.</b>	65190080 LA65190080 LAR65190080
<b>description</b>	operating capacitor capacity 5µF with plastic sheathing		
<b>For models:</b>	CEV026S, CEV061S, CEV101S, CG105M, COES026, COES061, COES101, CVE004H, CVE004M, CVE024S, CVE061S, CVE061X, CVE104H, CVE104M, CVE105H, CVE105M, CVEN061, CVES061, CVG061S, CVG061X, CVG105H, CVG105M, CVGN061, CVGS061, FME61A, FME61S, GGV07S, ICEM023, ICEM041, ICEM051, ICEM071, ICEM101, ICET023, ICET041, ICET051, ICET071, ICET101, ICGM051, ICGM071, ICGM101, ICGT051, ICGT071, ICGT101, KVE061S, KVE061X, KVG061X, ME106D, ME106H, ME106L, ME106M...(Other models you can see in the webshop)		

## ferrite rings

			
<b>1</b>			
<b>GEV No.</b>	691295	<b>Ref. No.</b>	65280450 LAR65280450
<b>description</b>	ferrite ring ID ø 17mm ED ø 28mm H 20mm for protection		
<b>For models:</b>	AME07D, AME07P, AME10D, AVE07D, AVE07P, AVE10D, AVE10P, AVG05P, AVG10D, AVG20D, CBEN061, CBES061, CEV026S, CEV026X, CEV061S, CEV061X, CEV101S, CEV101X, CME061S, CME061X, COEN026, COEN061, COEN101, COES026, COES061, COES101, CVE024S, CVE024X, CVE061S, CVE061X, CVEN061, CVES061, EM006H, EM010H, EM106H, EM106P, EM110H, EM110P, EM210H, EM210P, EMT06D, EMT10D, EMT20P, EMT21P, EV006P, EV010H, EV010P, EV106H, EV106P, EV110H...(Other models you can see in the webshop)		

			
<b>1</b>			
<b>GEV No.</b>	365054	<b>Ref. No.</b>	65280490 LAR65280490
<b>description</b>	ferrite ring ID ø 22mm ED ø 38mm H 17mm for protection		
<b>For models:</b>	ABE084S, ABE104S, ABG084X, ABG104X, ABG156S, AREN064, ARES064, ARES084, ARES154, ARGN064, ARGN084, ARGN154, ARGS064, ARGS084, ARGS154, BPE044P, BPE054P, BPE064P, BPE074P, BPE084P, BPE104P, BPG044P, BPG054P, BPG064P, BPG074P, BPG084P, BPG104P, CKES10, CVG061S, CVG061X, CVGN061, CVGS061, EPG056T, EPG086T, EPG156T, EPGV05T, EPGV08T, EPGV15T, EVEA20S, GEMT06P, GEMT06T, GEMT07S, GEMT07X, GEMT10P, GEMT10S, GEMT10T, GEMT20P, GEMT20S, GEMT20T, GEMT21P...(Other models you can see in the webshop)		

## filters

### interference suppression filters

			
<b>1</b>			
<b>GEV No.</b>	365044	<b>Ref. No.</b>	65280200 LA65280200 LAR65280200
<b>description</b>	interference suppression filter type FC701Y2F 250V 50-60Hz conductor 2 with E connection cable 200mm L 42mm ø 23mm Hmm Wmm plastic Qty 1 pcs		
<b>For models:</b>	ABE044M, ABE054M, ABE084S, ABE104S, ABE156X, ACE04M, ACE05M, ACE10M, AME07D, AME07P, AME10D, APE06, APE07, ARES064, ARES084, ARES154, AVE07D, AVE07P, AVE10D, AVE10P, BPE044M, BPE044P, BPE054M, BPE054P, BPE064P, BPE074P, BPE084P, BPE104P, CBEN061, CBES061, CE041M, CE051M, CE071M, CE100M, CE106M, CE110M, CE200M, CE210M, CEC40M, CES24M, CES40M, CG051M, CKES10, CME061S, CME061X, COEN026, COEN061, COEN101, COES026, COES061...(Other models you can see in the webshop)		

### RC circuits

			
<b>1</b>			
<b>GEV No.</b>	365155	<b>Ref. No.</b>	65280010 65280130 LAR65280010 LAR65280130
<b>description</b>	RC circuit 250/630V connection male faston 6.3mm cable length 65mm capacity 47nF 100Ohm		
<b>For models:</b>	ACE04M, ACE05M, ACE10M, ACG10M, APE06, APE07, APG08M, APG10M, BPE064M, BPE074M, BPE084M, BPE104M, CE041M, CE051M, CE071M, CE100M, CE106M, CE110M, CE200M, CE210M, CEC40M, CES24M, CES40M, CG051M, CG071M, CG100M, CG106M, CG110M, CG200M, CG210M, CGC24M, CGC40M, CGS24M, CGS40M, EC020M, EC106M, EC110M, EC210M, EM006M+SC, EM010M+SC, EM020M, EM106M, EM106M+SC, EM110M, EM110M+SC, EM210M, EM210M+SC, EV006M, EV010M, EV020M...(Other models you can see in the webshop)		





# fuses

## fine fuses

			
1			
<b>GEV No.</b>	358662	<b>Ref. No.</b>	65200080
<b>description</b>	fine fuse size ø5x20mm 0.125A fast-acting rated 250V Qty 10 pcs		
<b>For models:</b>	FME61A, FME61S, ME004L, ME004S, ME104L, ME104S, ME105L, ME105S, ME106L, ME106S, ME106T, ME110L, ME110S, ME110T, ME120L, ME120S, ME120T, ME210L, ME210S, ME210T, ME220L, ME220S, ME220T, MG105L, MG105S, MG106L, MG106S, MG106T, MG110L, MG110S, MG110T, MG120L, MG120S, MG120T, MG210L, MG210S, MG210T, MG220L, MG220S, MG220T, VE004S, VE104S, VE105S, VE106L, VE106S, VE106T, VE110L, VE110S, VE110T, VE210L... (Other models you can see in the webshop)		

			
1			
<b>GEV No.</b>	358532	<b>Ref. No.</b>	65200200 LA65200200 LAR65200200
<b>description</b>	fine fuse size ø5x20mm 2A fast-acting rated 250V Qty 10 pcs		
<b>For models:</b>	ABE044M, ABE054M, ABE084S, ABE104S, ABE156X, ABG156S, ACE04M, ACE05M, ACE10M, ACG10M, AME07D, AME07P, AME10D, APE06, APE07, APG08M, APG10M, AVE07D, AVE07P, AVE10D, AVE10P, AVG05P, AVG10D, AVG20D, BPE044M, BPE044P, BPE054M, BPE054P, BPE064M, BPE064P, BPE074M, BPE074P, BPE084M, BPE084P, BPE104M, BPE104P, BPG044M, BPG044P, BPG054M, BPG054P, BPG064M, BPG064P, BPG074M, BPG074P, BPG084M, BPG084P, BPG104M, BPG104P, CE041M, CE051M...(Other models you can see in the webshop)		

			
1			
<b>GEV No.</b>	358678	<b>Ref. No.</b>	65200370 LA65200370
<b>description</b>	fine fuse size ø5x20mm 8A fast-acting rated 250V Qty 10 pcs		

			
1			
<b>GEV No.</b>	358593	<b>Ref. No.</b>	65200086 LAR65200086 R65200088
<b>description</b>	fine fuse size ø5x20mm 0.125A slow-acting rated 250V Qty 10 pcs		
<b>For models:</b>	ABE044M, ABE054M, ABE084S, ABE104S, AVG05P, BPE044M, BPE044P, BPE054M, BPE054P, BPE064M, BPE064P, BPE074M, BPE074P, BPE084M, BPE084P, BPE104M, BPE104P, BPG044M, BPG044P, BPG054M, BPG054P, BPG064M, BPG064P, BPG074M, BPG074P, BPG084M, BPG084P, BPG104M, BPG104P, CVE004H, CVE104H, CVE105H, CVG105H, EM006H, EM006M+SC, EM010M+SC, EM106H, EM106M+SC, EM106P, EM110M+SC, EM110P, EM210M+SC, EM210P, EMT20P, EMT21P, EPE056T, EPE086T, EPE156T, EPEV05T, EPEV08T... (Other models you can see in the webshop)		

			
1			
<b>GEV No.</b>	358592	<b>Ref. No.</b>	65200140 65200300 LA65200300 LAR65200140 LAR65200300
<b>description</b>	fine fuse size ø5x20mm 0.1A slow-acting rated 250V Qty 10 pcs		
<b>For models:</b>	GMT20D, ME004L, ME004S, ME104L, ME104S, ME105L, ME105S, ME106L, ME106S, ME110L, ME110S, ME120L, ME120S, ME210L, ME210S, ME220L, ME220S, MG061M, MG101D, MG101M, MG102D, MG102M, MG105L, MG105S, MG106L, MG106S, MG110L, MG110S, MG120L, MG120S, MG201D, MG201M, MG210L, MG210S, MG220L, MG220S, MGMT20D, VG101D, VG101M, VG102D, VG102M, VG201D, VG201M		

			
1			
<b>GEV No.</b>	358595	<b>Ref. No.</b>	65200145 65200320 LA65200320 LAR65200145 LAR65200320
<b>description</b>	fine fuse size ø5x20mm 0.2A slow-acting rated 250V Qty 10 pcs		
<b>For models:</b>	ACE10M, AVE10D, AVG10D, AVG20D, BPE064P, BPE074P, BPG064P, BPG074P, CE100M, CE106M, CE200M, CG106M, EC106M, EM006H, EM006M+SC, EM010H, EM106H, EM106M, EM106M+SC, EM106P, EM110H, EM110P, EM210H, EM210P, EMT10D, EPE056T, EPEV05T, EPG056T, EPGV05T, EV006M, EV006P, EV010H, EV010P, EV106H, EV106M, EV106M+SC, EV106P, EV110H, EV110P, EV210H, EV210P, EVT20D, FE051X, FE1102P, FG051X, FG105X, FME101AX, FME201SX, FME61S, GC106M...(Other models you can see in the webshop)		

			
1			
<b>GEV No.</b>	358703	<b>Ref. No.</b>	65200350 LA65200350 LAR65200350
<b>description</b>	fine fuse size ø5x20mm 0.4A slow-acting rated 250V Qty 10 pcs		
<b>For models:</b>	ABE084S, ABE104S, ABE156X, ABG156S, BPE084P, BPE104P, BPG084P, BPG104P, CE110M, CE210M, CEC40M, CES24M, CES40M, CG110M, CG210M, CGC24M, CGC40M, CGS24M, CGS40M, EC020M, EC110M, EC210M, EM010H, EM010M+SC, EM020M, EM110H, EM110M, EM110M+SC, EM110P, EM210H, EM210M, EM210M+SC, EM210P, EPE086T, EPE156T, EPEV08T, EPEV15T, EPG086T, EPG156T, EPGV08T, EPGV15T, EV010H, EV010M, EV010P, EV020M, EV110H, EV110M, EV110M+SC, EV110P, EV210H...(Other models you can see in the webshop)		

			
1			
<b>GEV No.</b>	358600	<b>Ref. No.</b>	65200160
<b>description</b>	fine fuse size ø5x20mm 1A slow-acting rated 250V Qty 10 pcs		

electric components



			
1			
<b>GEV No.</b>	358603	<b>Ref. No.</b>	50304780
<b>description</b>	fine fuse size ø5x20mm 2A slow-acting rated 250V Qty 10 pcs		

			
1			
<b>GEV No.</b>	358609	<b>Ref. No.</b>	65200240 R65200240
<b>description</b>	fine fuse size ø5x20mm 5A slow-acting rated 250V Qty 10 pcs		
<b>For models:</b>	GEMT06T, GEVT06T, GGMT06T, GGVTO6T, HME061T, HME061X, HM-G061T, HMG061X, HVE061T, HVE061X, HVG061T, HVG061X, MG106M, MG106P, MG106X, MG110M, MG110P, MG110X, MG120M, MG120P, MG120X, MG210M, MG210P, MG210X, MG220M, MG220P, MG220X, MG227M, MG227P, MG227X		

**fine fuse holders**

			
1			
<b>GEV No.</b>	358512	<b>Ref. No.</b>	50302160 50305160 65210020 LA65210020 LAR50302160 LAR65210020
<b>description</b>	fuse holder		
<b>For models:</b>	ABE044M, ABE054M, ABE084S, ABE104S, ABG064M, ABG074M, ABG084X, ABG104X, ABG156S, ACE04M, ACE05M, ACE10M, ACG10M, AME07D, AME07P, AME10D, APE06, APE07, APG08M, APG10M, AREN084, AVE07D, AVE07P, AVE10D, AVE10P, AVG05P, AVG10D, AVG20D, BPE044M, BPE044P, BPE054M, BPE054P, BPE064M, BPE064P, BPE074M, BPE074P, BPE084M, BPE084P, BPE104M, BPE104P, BPG044M, BPG044P, BPG054M, BPG054P, BPG064M, BPG064P, BPG074M, BPG074P, BPG084M, BPG084P...(Other models you can see in the webshop)		

**overload switches**

			
1			
<b>GEV No.</b>	358514	<b>Ref. No.</b>	65160300 LA65160300 LAR65160300
<b>description</b>	overload switch drop-away current 0.8A		
<b>For models:</b>	AME07P, APE06, APE07, ARES064, ARG064, AVE07P, BPE064M, BPE064P, BPE074M, BPE074P, BPG064M, BPG064P, BPG074M, BPG074P, EM006H, EM106H, EM106P, EV006P, EV106H, EV106P, EVT06P, FE051X, FG051X, GM106H, GM106P, GMT06P, GV006H, GV106H, GV106P, GVT06P, ME061P, ME061T, ME106H, ME106P, MEMT06P, MEVT06P, MG061P, MG061T, MG106H, MG106P, MGMT06P, MGVT06P, MME071P, PE041X, PE051X, PE064M, PE064P, PE074M, PE074P, PG041X...(Other models you can see in the webshop)		

			
1			
<b>GEV No.</b>	358522	<b>Ref. No.</b>	50304370 65160400 LAR50304370 LAR65160400
<b>description</b>	overload switch drop-away current 1.5A		
<b>For models:</b>	FE05, FG05		

			
1			
<b>GEV No.</b>	358515	<b>Ref. No.</b>	65160310 LA65160310 LAR65160310
<b>description</b>	overload switch drop-away current 2.5A		
<b>For models:</b>	ARG064, CE106M, CG106M, EC106M, EM006H, EM006M+SC, EM106H, EM106M, EM106M+SC, EM106P, EV006M, EV006P, EV106H, EV106M, EV106M+SC, EV106P, FE051M, FE051X, FG051M, FG051X, GC106M, GEMT07S, GEVT07S, GGMT07S, GGVTO7S, GM106H, GM106M, GM106M+SC, GM106P, GV006H, GV006M, GV106H, GV106M, GV106M+SC, GV106P, KME081S, KMG081S, KVE081S, KVG081S, LBES071, LBG071, LVES071, LVGS071, ME106D, ME106H, ME106M, ME106P, ME106X, MG061H, MG061M...(Other models you can see in the webshop)		

			
1			
<b>GEV No.</b>	358520	<b>Ref. No.</b>	50304400 65160220 LAR50304400 LAR65160220
<b>description</b>	overload switch drop-away current 2.5A connection male faston 6.3mm		
<b>For models:</b>	FE051M, FE051X, FE105M, FE105X, FG051M, FG051X, FG105M, FG105X, ME05, MG05, MME05, PE04, PE040M, PE040X, PE041M, PE041X, PE051M, PE051X, PG04, PG040M, PG040X, PG041M, PG041X, PG051M, PG051X, RE05, RG05		

			
1			
<b>GEV No.</b>	358516	<b>Ref. No.</b>	65160320 LA65160320 LAR65160320
<b>description</b>	overload switch drop-away current 2A		
<b>For models:</b>	AME07D, AME07P, APE06, APE07, ARES064, AVE07D, AVE07P, BPE064M, BPE064P, BPE074M, BPE074P, BPG064M, BPG064P, BPG074M, BPG074P, CE071M, CG071M, EMT06D, EVT06D, EVT06P, GEMT06P, GEVT06P, GEVT06S, GGMT06P, GGVTO6P, GMT06D, GMT06P, GVT06D, GVT06P, HME061P, HMG061P, HVE061P, HVG061P, MACE07M, MACG07M, MCE071M, MCG071M, ME061D, ME061H, ME061M, ME061P, ME061T, MEMT06D, MEMT06P, MEVT06D, MEVT06P, MG061D, MG061M, MG061P, MG061T...(Other models you can see in the webshop)		



## electric accessories

### cables

#### ribbon cables

##### group 1



<b>GEV No.</b>	403107	<b>Ref. No.</b>	65301470 LAR65301470
<b>description</b>	ribbon cable 16-pole L 85mm plug type 2 row coded		
<b>For models:</b>	AME07P, AVE07P, AVE10P, EMT20P, EMT21P, EVT06P, EVT10P, GVT06P, ME061H, ME061P, ME101H, ME101P, ME102H, ME102P, ME201H, ME201P, ME202H, ME202P, MEMT06P, MEMT10P, MEMT20P, MEMT21P, MEVT06P, MEVT10P, MEVT20P, MEVT21P, MEVT40P, MG061H, MG061P, MG101H, MG101P, MG102H, MG102P, MG201H, MG201P, MG202H, MG202P, MGMT06P, MGMT10P, MGMT20P, MGMT21P, MGMT40P, MGVT06P, MGVT10P, MGVT20P, MGVT21P, MGVT40P, PE064P, PE074P...(Other models you can see in the web-shop)		

#### miscellaneous



<b>GEV No.</b>	403839	<b>Ref. No.</b>	66110310 LA66110310
<b>description</b>	cable for combi-steamer L 370m copper insulation glass fibre braiding/silicone rubber		
<b>For models:</b>	AREN064, ARES064, ARES084, ARGN064, ARG064, ARG084, CBEN061, CBES061, CME061S, CME061X, CVE061S, CVE061X, CVEN061, CVES061, CVG061S, CVG061X, CVGN061, CVGS061, GEMT07S, GEMT07X, GEVT07S, GEVT07X, GGMT07S, GGMT07X, GGV07S, GGV07X, KME061S, KME061X, KME072S, KME072X, KME081S, KME081X, KMG072S, KMG072X, KMG081S, KMG081X, KVE061S, KVE061X, KVE072S, KVE072X, KVE081S, KVE081X, KVG061X, KVG072X, KVG081X, LBES071, LBES072, LBES101, LBES102, LBET071...(Other models you can see in the webshop)		



<b>GEV No.</b>	403840	<b>Ref. No.</b>	66110330 LAR66110330
<b>description</b>	cable for combi-steamer L 860m copper insulation glass fibre braiding/silicone rubber		
<b>For models:</b>	GEMT21S, GEMT21X, GEMT40S, GEMT40X, GEVT21S, GEVT21X, GEVT40S, GEVT40X, GGMT21S, GGMT21X, GGMT40S, GGMT40X, GGV21S, GGV21X, GGV240S, GGV240X, KME201S, KME201X, KME202S, KME202X, KMG201S, KMG201X, KMG202S, KMG202X, KVE201S, KVE201X, KVE202S, KVE202X, KVG201X, KVG202X, NAE-B201R, NAE-B202R, NAEV201R, NAEV202R, NAGB201R, NAGB202R, NAGV201R, NAGV202R, SAEB201R, SAEB202R, SAEV201R, SAEV202R, SAGB201R, SAGB202R, SAGV201R, SAGV202R		



<b>GEV No.</b>	401960	<b>Ref. No.</b>	66110320 LA66110320 LAR66110320
<b>description</b>	kable set		
<b>For models:</b>	ABE084S, ABE104S, ABE156X, ABG064M, ABG074M, ABG084X, ABG104X, ABG156S, ACE10M, ACG10M, AME07D, AME07P, AME10D, APE06, APE07, APG08M, APG10M, AREN084, ARGN084, AVE07D, AVE07P, AVE10D, AVE10P, AVG10D, AVG20D, BPE064M, BPE064P, BPE074M, BPE074P, BPE084M, BPE084P, BPE104M, BPE104P, BPG064M, BPG064P, BPG074M, BPG074P, BPG084M, BPG084P, BPG104M, BPG104P, CE071M, CE100M, CE200M, CG071M, CG100M, CG200M, CKES10, EMT10D, EMT20P...(Other models you can see in the webshop)		

### terminals

#### connection terminals with screw/faston connections



<b>GEV No.</b>	550411	<b>Ref. No.</b>	1037104000
<b>description</b>	power terminal block 6-pole max. 40A max 450V connection ø6mm <sup>2</sup> / F6.3 temp.-resist. 150°C cross section 6mm <sup>2</sup>		

#### rail-mounted terminals

##### rail-mounted terminal blocks

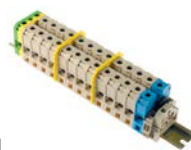

<b>GEV No.</b>	550552	<b>Ref. No.</b>	50304742 65220140 LAR50304742 LAR65220140
<b>description</b>	rail-mounted terminal block		
<b>For models:</b>	ME40, MME40		



<b>GEV No.</b>	550421 <sup>1</sup>	<b>Ref. No.</b>	50304720 65220090 65220091 LAR50304720 LAR65220090 LAR65220091
<b>description</b>	rail-mounted terminal block 5-pole contacts 3P+N+E cross section 1.0-10mm <sup>2</sup>		
<b>For models:</b>	A05PES, A05PES+UM, A05RES, A05RES+UM, A08PES, A08PES+UM, A08RES, A08RES+UM, A10PES, A10PES+UM, A10RES, A10RES+UM, ABE044M, ABE054M, ACE04M, ACE05M, AME07D, AME07P, APE06, APE07, AVE07D, AVE07P, AVG05P, BPE044M, BPE044P, BPE054M, BPE054P, BPE064M, BPE064P, BPE074M, BPE074P, CE041M, CE051M, CE071M, CE106M, CEV061S, CEV061X, CG051M, CG105M, CME061X, COEN061, CVE004H, CVE004M, CVE024S, CVE061S, CVE104H, CVE104M, CVE105H, CVE105M, CVG105H...(Other models you can see in the webshop)		

<sup>1</sup>with fused terminal block

			
1			
<b>GEV No.</b>	550420	<b>Ref. No.</b>	65220080 65220081 65225000 LAR65220080 LAR65220081 LAR65225000
<b>description</b>	rail-mounted terminal block 5-pole contacts 3P+N+E cross section 1.5-16mm <sup>2</sup>		
<b>For models:</b>	ACE10M, AME10D, AVE10D, AVE10P, BPE084M, BPE084P, BPE104M, BPE104P, CE100M, CE110M, EC110M, EM010H, EM010M+SC, EM110H, EM110M, EM110M+SC, EM110P, EMT10D, EPG056T, EPG086T, EPGV05T, EPGV08T, EVO10H, EVO10M, EVO10P, EV110H, EV110M, EV110M+SC, EV110P, EVT10P, FE102M, FE102X, FE210M, FE210X, FE102P, FME101AX, GEMT10P, GEMT10T, GEVT10P, GEVT10T, HME101P, HME101S, HME101T, HME101X, HVE101P, HVE101S, HVE101T, HVE101X, MACE10M, MCE101M...(Other models you can see in the webshop)		

			
1			
<b>GEV No.</b>	550422	<b>Ref. No.</b>	50304741 65220130 65220131 65225020 LAR50304741 LAR65220130 LAR65220131 LAR65225020
<b>description</b>	rail-mounted terminal block 9-pole		
<b>For models:</b>	CE210M, CEC40M, CES24M, CES40M, EC020M, EC210M, EM020M, EM210H, EM210M, EM210M+SC, EM210P, EMT20P, EMT21P, EV020M, EV210H, EV210M, EV210M+SC, EV210P, EVT20D, FME201SX, GEMT40P, GEMT40T, GEVT40P, GEVT40T, HME202P, HME202S, HME202T, HME202X, HVE202P, HVE202T, HVE202X, MCE202M, ME102D, ME102H, ME102M, ME102P, ME102T, ME120D, ME120H, ME120L, ME120M, ME120P, ME120S, ME120T, ME120X, ME15, ME20, ME201D, ME201H, ME201M...(Other models you can see in the webshop)		



## electronic magnets

			
1			
<b>GEV No.</b>	698948	<b>Ref. No.</b>	65090310 LA65090310 LAR65090310
<b>description</b>	electronic magnet 220V voltage AChz L 164mm W 65mm H 45mm 400W		
<b>For models:</b>	AREN064, AREN084, ARGN064, ARGN084, NAEB071, NAEB071R, NAEB072R, NAEB101, NAEB101R, NAEB102, NAEB102R, NAEBO72, NAEV071, NAEV071R, NAEV072, NAEV072R, NAEV101, NAEV101R, NAEV102, NAEV102R, NAGB071, NAGB071R, NAGB072, NAGB072R, NAGB101, NAGB101R, NAGB102, NAGB102R, NAGV071, NAGV071R, NAGV072, NAGV072R, NAGV101, NAGV101R, NAGV102, NAGV102R		

## gas valves and ignition boxes

### gas control valves

#### HONEYWELL

			
1			
<b>GEV No.</b>	106004	<b>Ref. No.</b>	63020150 LA63020150 LAR63020150
<b>description</b>	gas valve type VK4105C 220-240V 50/60Hz gas inlet flange 32x32mm gas outlet flange 32x32mm thermocouple connection pilot connection pressure range 15-60mbar max 60mbar operator type pressure controller type V5306E 1234 1 suitable for HONEYWELL hole distance 24mm flange 32x32mm		
<b>For models:</b>	CG106M, CG110M, CG210M, FG051M, FG051X, FG101M, FG101X, FG102M, FG102X, GC010M, GC106M, GC110M, GC210M, GV006M, GV010M, GV106M, GV106M+SC, GV110M, GV110M+SC, GV210M, GV210M+SC, PG041M, PG041X, PG051X, PG081M, PG081X, PG101M, PG101X, VG106D, VG106M, VG106X, VG110D, VG110M, VG110X, VG210D, VG210M, VG210X		
<b>accessories for</b>	106004		
	<b>GEV No.</b>	102845	<b>Ref. No.</b> —
	gas connection angled 1/2" flange 32x32mm hole distance 24x24mm Tandem		
	<b>GEV No.</b>	102846	<b>Ref. No.</b> —
	gas connection straight 1/2" flange 32x32mm hole distance 24x24mm suitable for Tandem		



			
1			
<b>GEV No.</b>	102320	<b>Ref. No.</b>	63020160 LA63020160 LAR63020160
<b>description</b>	gas valve type VK4105Q 220-240V 50/60Hz gas inlet flange 32x32mm gas outlet flange 32x32mm thermocouple connection pilot connection pressure range 15-60mbar max 60mbar operator type HONEYWELL coil type 220/240V (V4336A 2212 1) hole distance 24mm flange 32x32mm		
<b>For models:</b>	GM020H, GM020M, GM106H, GM106M, GM106M+SC, GM106P, GM110H, GM110M, GM110M+SC, GM110P, GM210H, GM210M, GM210M+SC, GM210P, GV006H, GV010H, GV020H, GV106H, GV106P, GV110H, GV110P, GV210H, GV210P, MG106D, MG106M, MG106X, MG110D, MG110M, MG110X, MG210D, MG210M, MG210X		
<b>accessories for</b>	102320		
	<b>GEV No.</b>	102845	<b>Ref. No.</b> —
	gas connection angled 1/2" flange 32x32mm hole distance 24x24mm Tandem		

Table continues overleaf







<b>accessories for</b>	102320		
	GEV No.	102846	Ref. No. —
gas connection straight 1/2" flange 32x32mm hole distance 24x24mm suitable for Tandem			





<b>GEV No.</b>	106012	<b>Ref. No.</b>	63020170 LAR63020170
<b>description</b>	gas valve type VK4115V 220-240V 50/60Hz gas inlet flange 32x32mm gas outlet flange 32x32mm thermocouple connection pilot connection pressure range 15-60mbar max 60mbar operator type HONEYWELL hole distance 24mm flange 32x32mm		
<b>For models:</b>	ABG064M, ABG074M, ABG084X, ABG104X, ABG156S, ACG10M, APG08M, APG10M, ARGN064, ARGN084, ARGN154, ARG5064, ARG5084, ARG5154, AVG05P, AVG10D, AVG20D, BPG044M, BPG044P, BPG054M, BPG054P, BPG064M, BPG064P, BPG074M, BPG074P, BPG084M, BPG084P, BPG104M, BPG104P, CG051M, CG071M, CG100M, CG200M, CVG061S, CVG061X, EPG056T, EPG086T, EPG156T, EPGV05T, EPGV08T, EPGV15T, GGMT06P, GGMT06T, GGMT07S, GGMT07X, GGMT10P, GGMT10S, GGMT10T, GGMT10X, GGMT20P...(Other models you can see in the webshop)		

<b>accessories for</b>	106012		
	GEV No.	102845	Ref. No. —
gas connection angled 1/2" flange 32x32mm hole distance 24x24mm Tandem			
	GEV No.	102846	Ref. No. —
gas connection straight 1/2" flange 32x32mm hole distance 24x24mm suitable for Tandem			



<b>GEV No.</b>	101395	<b>Ref. No.</b>	63020010 LA63020010 LAR63020010
<b>description</b>	gas valve type VR4605P 230V 50Hz gas inlet 1/2" gas outlet 1/2" thermocouple connection pilot connection pressure range 8-50mbar operator type 230V (V404A 1071) pressure controller type 220/240V (V404A 1071 4) HONEYWELL coil type 220/240V (V4336A 2220) flange 45x45mm		
<b>For models:</b>	CG105M, CGC24M, CGC40M, CGS24M, CGS40M, CVG105H, CVG105M, FMG201A, FMG201S, MG105L, MG105S, MG106D, MG106H, MG106L, MG106M, MG106P, MG106S, MG106T, MG106X, MG110D, MG110H, MG110L, MG110M, MG110P, MG110S, MG110T, MG110X, MG120D, MG120H, MG120L, MG120M, MG120P, MG120S, MG120T, MG120X, MG210D, MG210H, MG210L, MG210M, MG210P, MG210S, MG210T, MG210X, MG220D, MG220H, MG220L, MG220M, MG220P, MG220S, MG220T...(Other models you can see in the webshop)		

<b>accessories for</b>	101395		
	GEV No.	101320	Ref. No. —
cover suitable for gas valves HONEYWELL			



<b>accessories for</b>	101395		
	GEV No.	102845	Ref. No. —
gas connection angled 1/2" flange 32x32mm hole distance 24x24mm Tandem			



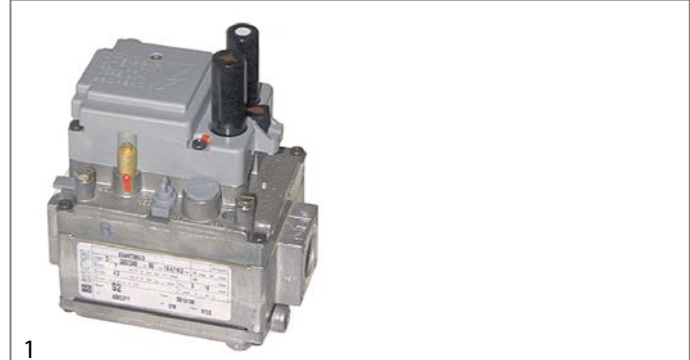



	GEV No.	102846	Ref. No. —
gas connection straight 1/2" flange 32x32mm hole distance 24x24mm suitable for Tandem			

SIT  
ELETTROSIT











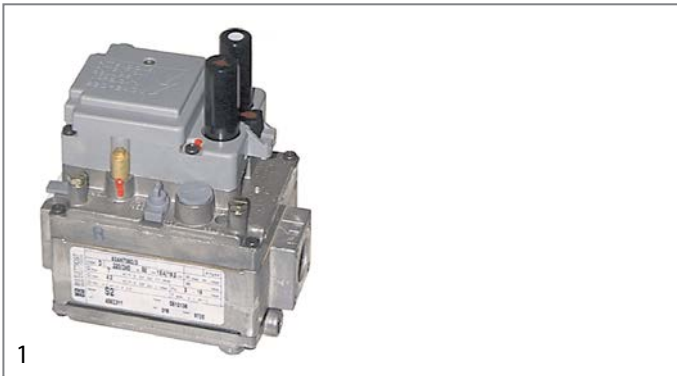

<b>GEV No.</b>	101126	<b>Ref. No.</b>	50203151 63025020 LAR50203151 LAR63025020
<b>description</b>	gas valve SIT type ELETTROSIT 230V gas inlet 1/2" gas outlet 1/2" thermocouple connection M9x1 pilot connection M10x1 bottom equiv. no. 0.810.136		
<b>For models:</b>	FG05, FG051M, FG051X, FG105M, FG105X, MG05, PG04, PG040M, PG040X, PG041M, PG041X, PG051M, PG051X, RG05		

<b>spare parts for</b>	101126		
	GEV No.	101312	Ref. No. 5001050
microswitch			
	GEV No.	101352	Ref. No. —
solenoid coil 230V 50Hz suitable for ELETTROSIT			









<b>accessories for</b>	101126		
	GEV No.	100006	Ref. No. —
piezoelectric igniter suitable for ELETTROSIT body plastic blowing connection ø2.4mm ø 14mm			
	GEV No.	100904	Ref. No. 1394700
locking screw M10x1 for pipe ø 4mm Qty 1 pcs			
	GEV No.	100905	Ref. No. —
locking screw M10x1 for pipe ø 6mm Qty 1 pcs			
	GEV No.	101301	Ref. No. —
gas connection thread 1/2" straight ELETTROSIT screw with O-ring			
	GEV No.	101303	Ref. No. —
gas connection straight thread 3/4" ELETTROSIT			
	GEV No.	101309	Ref. No. —
extension			

2 gas components





<b>GEV No.</b>	101993	<b>Ref. No.</b>	5001051
<b>description</b>	gas valve SIT type ELETTROSIT 230V gas inlet 1/2" gas outlet 1/2" thermocouple connection M9x1 pilot connection M10x1 lateral equiv. no. 0.810.126		
<b>spare parts for</b>	101993		
	<b>GEV No.</b>	101312	<b>Ref. No.</b> 5001050
	microswitch		
	<b>GEV No.</b>	101352	<b>Ref. No.</b> —
	solenoid coil 230V 50Hz suitable for ELETTROSIT		
<b>accessories for</b>	101993		
	<b>GEV No.</b>	100006	<b>Ref. No.</b> —
	piezoelectric igniter suitable for ELETTROSIT body plastic blowing connection ø2.4mm ø 14mm		
	<b>GEV No.</b>	100904	<b>Ref. No.</b> 1394700
	locking screw M10x1 for pipe ø 4mm Qty 1 pcs		
	<b>GEV No.</b>	100905	<b>Ref. No.</b> —
	locking screw M10x1 for pipe ø 6mm Qty 1 pcs		
	<b>GEV No.</b>	101301	<b>Ref. No.</b> —
	gas connection thread 1/2" straight ELETTROSIT screw with O-ring		
	<b>GEV No.</b>	101303	<b>Ref. No.</b> —
	gas connection straight thread 3/4" ELETTROSIT		
	<b>GEV No.</b>	101309	<b>Ref. No.</b> —
	extension		
	<b>GEV No.</b>	103104	<b>Ref. No.</b> —
	ignition switch		
	<b>GEV No.</b>	541504	<b>Ref. No.</b> —
	double nipple thread 1/2" - 1/2"		





<b>GEV No.</b>	101127	<b>Ref. No.</b>	50203161 63025030 LAR50203161 LAR63025030
<b>description</b>	gas valve SIT type ELETTROSIT 230V gas inlet 3/4" gas outlet 3/4" thermocouple connection M9x1 pilot connection M10x1 lateral equiv. no. 0.810.175		
<b>For models:</b>	FG102M, FG102X, FG110M, FG110X, FG210M, FG210X, MG05, MG10, MG15, MG21, MG24, MG40, PG08, PG080M, PG080X, PG12, RG07, RG10, RG20, RG24, RG40		
<b>spare parts for</b>	101127		
	<b>GEV No.</b>	101312	<b>Ref. No.</b> 5001050
	microswitch		
	<b>GEV No.</b>	101352	<b>Ref. No.</b> —
	solenoid coil 230V 50Hz suitable for ELETTROSIT		
<b>accessories for</b>	101127		
	<b>GEV No.</b>	100006	<b>Ref. No.</b> —
	piezoelectric igniter suitable for ELETTROSIT body plastic blowing connection ø2.4mm ø 14mm		
	<b>GEV No.</b>	100904	<b>Ref. No.</b> 1394700
	locking screw M10x1 for pipe ø 4mm Qty 1 pcs		
	<b>GEV No.</b>	100905	<b>Ref. No.</b> —
	locking screw M10x1 for pipe ø 6mm Qty 1 pcs		
	<b>GEV No.</b>	101301	<b>Ref. No.</b> —
	gas connection thread 1/2" straight ELETTROSIT screw with O-ring		
	<b>GEV No.</b>	101303	<b>Ref. No.</b> —
	gas connection straight thread 3/4" ELETTROSIT		
	<b>GEV No.</b>	101309	<b>Ref. No.</b> —
	extension		



 <p>1</p>			
<b>GEV No.</b>	101122	<b>Ref. No.</b>	63025010
<b>description</b>	gas valve SIT type ELETTROSIT 24V gas inlet 3/4" gas outlet 3/4" thermocouple connection M9x1 equiv. no. 0.810.171 pilot outlet M10x1		
<b>spare parts for</b>	101122		
	<b>GEV No.</b>	101312	<b>Ref. No.</b> 5001050
	microswitch		
<b>accessories for</b>	101122		
	<b>GEV No.</b>	100006	<b>Ref. No.</b> —
	piezoelectric igniter suitable for ELETTROSIT body plastic blowing connection ø2.4mm ø 14mm		
	<b>GEV No.</b>	100904	<b>Ref. No.</b> 1394700
	locking screw M10x1 for pipe ø 4mm Qty 1 pcs		
	<b>GEV No.</b>	100905	<b>Ref. No.</b> —
	locking screw M10x1 for pipe ø 6mm Qty 1 pcs		
	<b>GEV No.</b>	101301	<b>Ref. No.</b> —
	gas connection thread 1/2" straight ELETTROSIT screw with O-ring		
	<b>GEV No.</b>	101303	<b>Ref. No.</b> —
	gas connection straight thread 3/4" ELETTROSIT		
	<b>GEV No.</b>	101309	<b>Ref. No.</b> —
	extension		



<b>NOVASIT</b>			
<b>accessories</b>			
 <p>1</p>			
<b>GEV No.</b>	101306	<b>Ref. No.</b>	63080020 LAR63080020
<b>description</b>	gas connection angled flange 45x45mm hole distance 36x36mm 1/2" ELETTROSIT/V4400/4600/4605 screw with O-ring suitable for SIT/HONEYWELL		
<b>For models:</b>	CG105M, CGC24M, CGC40M, CGS24M, CGS40M, CVG105H, CVG105M, FMG201A, FMG201S, MG105L, MG105S, MG106D, MG106H, MG106L, MG106M, MG106P, MG106S, MG106T, MG106X, MG110D, MG110H, MG110M, MG110L, MG110S, MG110T, MG110X, MG210D, MG210H, MG210L, MG210M, MG210P, MG210S, MG210T, MG210X, MG210Y, MG220D, MG220H, MG220L, MG220M, MG220P, MG220S, MG220T, MG220X, MG220Y...(Other models you can see in the webshop)		
<b>spare parts for</b>	101306		
	<b>GEV No.</b>	517104	<b>Ref. No.</b> —
	O-ring EPDM thickness 2.62mm ID ø 31.42mm Qty 1 pcs		

 <p>1</p>			
<b>GEV No.</b>	101305	<b>Ref. No.</b>	63080010 LAR63080010
<b>description</b>	gas connection straight 1/2" flange 45x45mm ELETTROSIT/V4400/4600/4605 suitable for SIT/HONEYWELL hole distance 36x36mm		
<b>For models:</b>	FMG201A, FMG201S, MG106D, MG106H, MG106L, MG106M, MG106P, MG106S, MG106T, MG106X, MG110D, MG110H, MG110L, MG110M, MG110P, MG110S, MG110T, MG110X, MG210D, MG210H, MG210L, MG210M, MG210P, MG210S, MG210T, MG210X, PG005D, PG005K, PG005M, PG008D, PG008K, PG008M, PG015D, PG015K, PG015M, PG088D, PG088K, PG088M, PG105D, PG105K, PG105M, PG105T, PG108D, PG108K, PG108M, PG108T, PG115D, PG115K, PG115M, PG115T...(Other models you can see in the webshop)		
<b>spare parts for</b>	101305		
	<b>GEV No.</b>	101503	<b>Ref. No.</b> —
	O-ring EPDM thickness 2mm ID ø 32mm Qty 1 pcs		

 <p>1</p>			
<b>GEV No.</b>	101312	<b>Ref. No.</b>	5001050
<b>description</b>	microswitch		

ignition boxes

HONEYWELL

 <p>1</p>			
<b>GEV No.</b>	101165	<b>Ref. No.</b>	63060020 LA63060020 LAR63060020
<b>description</b>	ignition box HONEYWELL type S4560A 1008 equiv. no. S4560A 1008 electrodes 1 waiting time 0s safety time 10s 220-240V 10VA 50Hz		
<b>For models:</b>	FMG201A, FMG201S, MG105L, MG105S, MG106L, MG106S, MG106T, MG110L, MG110S, MG110T, MG120L, MG120S, MG120T, MG210L, MG210S, MG210T, MG220L, MG220S, MG220T, PG005D, PG005M, PG008D, PG008M, PG015D, PG015M, PG088D, PG088M, PG105D, PG105M, PG105T, PG108D, PG108M, PG108T, PG115D, PG115M, PG115T, PG188D, PG188M, PG188T, VG105S, VG106L, VG106S, VG106T, VG110L, VG110S, VG110T, VG210L, VG210S, VG210T		
<b>spare parts for</b>	101165		
	<b>GEV No.</b>	358696	<b>Ref. No.</b> —
	fine fuse size ø5x20mm 4A medium lag rated 250V Qty 10 pcs		



**Honeywell**



1

<b>GEV No.</b>	102367	<b>Ref. No.</b>	63060120 LAR63060120
<b>description</b>	ignition box HONEYWELL type S4565A 2092 1 electrodes 3 waiting times safety time 10s 220-240V 4VA 50/60Hz		
<b>For models:</b>	ACG10M, APG08M, APG10M, AVG05P, AVG10D, AVG20D, CG051M, CG071M, CG100M, CG200M, GMT06D, GMT06P, GMT20D, GMT20P, GVT06D, GVT06P, GVT20D, HMG061X, HMG101X, HMG102X, HMG201X, HMG202X, MACG05M, MACG07M, MACG10M, MACG20M, MG061D, MG061H, MG061M, MG061P, MG061T, MG101D, MG101H, MG101M, MG101P, MG101T, MG102D, MG102H, MG102M, MG102P, MG102T, MG201D, MG201H, MG201M, MG201P, MG201T, MG202D, MG202H, MG202M, MG202P...(Other models you can see in the webshop)		

**Honeywell**



1

<b>GEV No.</b>	101184	<b>Ref. No.</b>	63060140 LA63060140 LAR63060140
<b>description</b>	ignition box HONEYWELL type S4565C 1033 equiv. no. S4565C 1033 electrodes 2 waiting times safety time 5s 220-240V 4VA 50/60Hz		
<b>For models:</b>	BPG044M, BPG044P, BPG054M, BPG054P, BPG064M, BPG064P, BPG074M, BPG074P, BPG084M, BPG084P, BPG104M, BPG104P, GGMT06P, GGMT06T, GGMT10P, GGMT10T, GGMT20P, GGMT20T, GGMT21P, GGMT21T, GGMT40P, GGMT40T, GGVT06P, GGVT06T, GGVT10P, GGVT10T, GGVT20P, GGVT20T, GGVT21P, GGVT21T, GGVT40P, GGVT40T, HMG061P, HMG061T, HMG061X, HMG101P, HMG101T, HMG101X, HMG102P, HMG102T, HMG102X, HMG201P, HMG201T, HMG201X, HMG202P, HMG202T, HMG202X, HVG061P, HVG061T, HVG061X...(Other models you can see in the webshop)		

**Honeywell**



1

<b>GEV No.</b>	102318	<b>Ref. No.</b>	63060100 LA63060100 LAR63060100
<b>description</b>	ignition box HONEYWELL type S4565AF 1007V01 electrodes 2 waiting times safety time 10s 220-240V 4VA 50/60Hz		
<b>For models:</b>	CG106M, CG110M, CG210M, FG051M, FG051X, FG101M, FG101X, FG102M, FG102X, GC010M, GC020M, GC106M, GC110M, GC210M, GM020H, GM020M, GM106H, GM106M, GM106M+SC, GM106P, GM110H, GM110M, GM110M+SC, GM110P, GM210H, GM210M, GM210M+SC, GM210P, GV006H, GV006M, GV010H, GV010M, GV020H, GV106H, GV106M, GV106M+SC, GV106P, GV110H, GV110M, GV110M+SC, GV110P, GV210H, GV210M, GV210M+SC, GV210P, MG106D, MG106M, MG106X, MG110D, MG110M...(Other models you can see in the webshop)		

**Honeywell**



1

<b>GEV No.</b>	103109	<b>Ref. No.</b>	63060160 LA63060160 LAR63060160
<b>description</b>	ignition box HONEYWELL type S4565C 1116 electrodes 2 waiting times safety time 5s 220-240V 4VA 50/60Hz		
<b>For models:</b>	ABG064M, ABG074M, ABG084X, ABG104X, ABG156S, ARGN064, ARGN084, ARGN154, ARGS064, ARGS084, ARGS154, BPG044M, BPG044P, BPG054M, BPG054P, BPG064M, BPG064P, BPG074M, BPG074P, BPG084M, BPG084P, BPG104M, BPG104P, CVG061S, CVG061X, EPG056T, EPG086T, EPG156T, EPGV05T, EPGV08T, EPGV15T, GGMT06P, GGMT06T, GGMT07S, GGMT07X, GGMT10P, GGMT10S, GGMT10T, GGMT10X, GGMT20P, GGMT20S, GGMT20T, GGMT20X, GGMT21P, GGMT21S, GGMT21T, GGMT21X, GGMT40P, GGMT40S, GGMT40T...(Other models you can see in the webshop)		

**miscellaneous**



1

<b>GEV No.</b>	401171	<b>Ref. No.</b>	6010084
<b>description</b>	ignition box		
<b>For models:</b>	VE102MX		



# ignition parts

## pilot burners

### SIT

#### 100 series



GEV No.	106906	Ref. No.	50203220 63050020 6A013200 BN6A013200 LAR50203220 LAR63050020
---------	--------	----------	--

**description** pilot burner SIT type 100 series 3 flames nozzle ø 0.2mm gas connection 6mm

**For models:** FG05, FG051M, FG051X, FG102M, FG102X, FG105M, FG105X, FG110M, FG110X, FG210M, FG210X, MG05, MG10, MG15, MG21, MG24, MG40, PG04, PG040M, PG040X, PG041M, PG041X, PG051M, PG051X, PG08, PG080M, PG080X, PG12, RG05, RG07, RG10, RG20, RG24, RG40

**spare parts for** 106906

GEV No.	100245	Ref. No.	1415100
	pilot burner nozzle LPG code 20 bore ø 0.2mm Qty 1 pcs thread M8x0.75		
GEV No.	100855	Ref. No.	—
	pilot burner bracket triple		
GEV No.	100885	Ref. No.	—
	air mixing sleeve for pilot burner Qty 1 pcs		
GEV No.	100916	Ref. No.	—
	compression spring for pilot burner Qty 1 pcs		
GEV No.	100917	Ref. No.	—
	gasket for pilot burner Qty 1 pcs aluminium ID ø 8.5mm ED ø 11mm thickness 1.2mm		
GEV No.	100918	Ref. No.	—
	screw for pilot burner		
GEV No.	107162	Ref. No.	—
	pilot burner cap SIT 3 flames Hmm Lmm Qty 1 pcs		
GEV No.	107701	Ref. No.	—
	pilot burner bottom part SIT 100 series nozzle ø 0.2mm		

**accessories for** 106906

GEV No.	100245	Ref. No.	1415100
	pilot burner nozzle LPG code 20 bore ø 0.2mm Qty 1 pcs thread M8x0.75		
GEV No.	100246	Ref. No.	—
	pilot burner nozzle natural gas bore ø 0.35mm Qty 1 pcs thread M8x0.75		
GEV No.	100904	Ref. No.	1394700
	locking screw M10x1 for pipe ø 4mm Qty 1 pcs		
GEV No.	100905	Ref. No.	—
	locking screw M10x1 for pipe ø 6mm Qty 1 pcs		

accessories for		106906	
GEV No.	102110	Ref. No.	—
	pilot tube copper pipe ø 4mm thickness 1mm L 3000mm		
GEV No.	102111	Ref. No.	—
	pilot tube copper pipe ø 6mm thickness 1mm L 3000mm		
GEV No.	107171	Ref. No.	1842300
	pilot burner nozzle SIT natural/liquid gas bore ø 0.25mm Qty 1 pcs		
GEV No.	107700	Ref. No.	—
	pilot burner bottom part SIT 100 series nozzle ø 0.25mm		
GEV No.	107702	Ref. No.	—
	pilot burner bottom part SIT 100 series nozzle ø 0.35mm		



GEV No.	106907	Ref. No.	588730
---------	--------	----------	--------

**description** pilot burner SIT type 100 series 3 flames nozzle ø 0.35mm gas connection 6mm

**spare parts for** 106907

GEV No.	100246	Ref. No.	—
	pilot burner nozzle natural gas bore ø 0.35mm Qty 1 pcs thread M8x0.75		
GEV No.	100855	Ref. No.	—
	pilot burner bracket triple		
GEV No.	100885	Ref. No.	—
	air mixing sleeve for pilot burner Qty 1 pcs		
GEV No.	100916	Ref. No.	—
	compression spring for pilot burner Qty 1 pcs		
GEV No.	100917	Ref. No.	—
	gasket for pilot burner Qty 1 pcs aluminium ID ø 8.5mm ED ø 11mm thickness 1.2mm		
GEV No.	100918	Ref. No.	—
	screw for pilot burner		
GEV No.	107162	Ref. No.	—
	pilot burner cap SIT 3 flames Hmm Lmm Qty 1 pcs		
GEV No.	107702	Ref. No.	—
	pilot burner bottom part SIT 100 series nozzle ø 0.35mm		

**accessories for** 106907

GEV No.	100245	Ref. No.	1415100
	pilot burner nozzle LPG code 20 bore ø 0.2mm Qty 1 pcs thread M8x0.75		
GEV No.	100904	Ref. No.	1394700
	locking screw M10x1 for pipe ø 4mm Qty 1 pcs		

Table continues overleaf









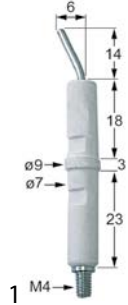



accessories for 106907				
	GEV No.	100905	Ref. No.	—
	locking screw M10x1 for pipe ø 6mm Qty 1 pcs			
	GEV No.	102110	Ref. No.	—
	pilot tube copper pipe ø 4mm thickness 1mm L 3000mm			
	GEV No.	102111	Ref. No.	—
	pilot tube copper pipe ø 6mm thickness 1mm L 3000mm			
	GEV No.	107171	Ref. No.	1842300
	pilot burner nozzle SIT natural/liquid gas bore ø 0.25mm Qty 1 pcs			
	GEV No.	107700	Ref. No.	—
	pilot burner bottom part SIT 100 series nozzle ø 0.25mm			
	GEV No.	107701	Ref. No.	—
	pilot burner bottom part SIT 100 series nozzle ø 0.2mm			

	GEV No.	100707	Ref. No.	50102720 63050010 LAR50102720 LAR63050010
	description ignition electrode D1 ø 7mm D2 ø 9mm connection ø2.4mm L1 14mm L2 6mm BL1 18mm BL2 3mm BL3 23mm to clip Qty 1 pcs			
	For models: FG05, FG051M, FG051X, FG102M, FG102X, FG105M, FG105X, FG110M, FG110X, FG210M, FG210X, MG05, MG10, MG15, MG21, MG24, MG40, PG04, PG040M, PG040X, PG041M, PG041X, PG051M, PG051X, PG08, PG080M, PG080X, PG12, RG05, RG07, RG10, RG20, RG24, RG40			







accessories				
pilot burner nozzles				
	GEV No.	100245	Ref. No.	1415100
	description pilot burner nozzle LPG code 20 bore ø 0.2mm Qty 1 pcs thread M8x0.75			

ignition electrodes				
	GEV No.	100706	Ref. No.	1888300 MA1888300 MA224211
	description ignition electrode connection M4 Qty 1 pcs			

140 - 145 -150 series				
	GEV No.	107114 <sup>1</sup>	Ref. No.	29000 MACM029000
	description pilot burner SIT type 140 series 2 flames nozzle ømm gas connect-onmm			
	spare parts for 107114			
	GEV No.	100907	Ref. No.	1891700
	screw connection thread M10x1 Qty 1 pcs type SEF 1 ømm for thermocouple			
	accessories for 107114			
	GEV No.	100204	Ref. No.	1888000 MA1888000
	pilot burner nozzle SIT LPG code 14 bore ø 0.18/0.20mm Qty 1 pcs suitable for 140 series			
	GEV No.	100205	Ref. No.	—
	pilot burner nozzle SIT LPG code 19 bore ø 0.23/0.26mm Qty 1 pcs suitable for SIT 150 series			
	GEV No.	100206	Ref. No.	—
	pilot burner nozzle SIT natural gas code 36 bore ø 0.60/0.55mm Qty 1 pcs suitable for SIT 150 series			
	GEV No.	100207	Ref. No.	MA1887800
	pilot burner nozzle SIT natural gas code 27 bore ø 0.40/0.38mm suitable for SIT 140 series			
	GEV No.	100216	Ref. No.	—
	pilot burner nozzle SIT natural gas code 38 bore ø 0.45mm Qty 1 pcs suitable for SIT 150 series			
	GEV No.	100701	Ref. No.	1949900
	ignition electrode connection M4 Qty 1 pcs			
	GEV No.	100801	Ref. No.	—
	gasket for pilot burner Qty 1 pcs			
	GEV No.	100897	Ref. No.	1887800
	olive for pipe ø 4mm Qty 1 pcs for pilot burner			

<sup>1</sup>incl. thermocouple fitting  
Table continues overleaf



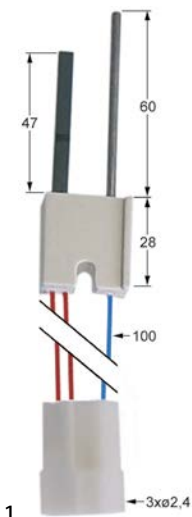

<b>accessories for</b>	107114			
	<b>GEV No.</b>	100898	<b>Ref. No.</b>	—
	olive for pipe $\varnothing$ 6mm Qty 1 pcs for pilot burner			
	<b>GEV No.</b>	100906	<b>Ref. No.</b>	1888100
	screw connection thread M10x1 for ignition electrode brass Qty 1 pcs WS 10			
	<b>GEV No.</b>	100908	<b>Ref. No.</b>	1888400
	union screw thread M10x1 for pipe $\varnothing$ 4mm Qty 1 pcs			
	<b>GEV No.</b>	100909	<b>Ref. No.</b>	62060223 LA62060223 LAR62060223 R62060223
	union screw thread M10x1 for pipe $\varnothing$ 6mm Qty 1 pcs			
	<b>GEV No.</b>	102110	<b>Ref. No.</b>	—
	pilot tube copper pipe $\varnothing$ 4mm thickness 1mm L 3000mm			
	<b>GEV No.</b>	102111	<b>Ref. No.</b>	—
	pilot tube copper pipe $\varnothing$ 6mm thickness 1mm L 3000mm			

electrodes

	1			
<b>GEV No.</b>	100730	<b>Ref. No.</b>	63050040 LAR63050040	
<b>description</b>	glow plug cable length 100mm connection $\varnothing$ 2.4mm L1 47mm L2 60mm			
<b>For models:</b>	CG105M, CGC24M, CGC40M, CGS24M, CGS40M, CVG105H, CVG105M, MG106D, MG106H, MG106M, MG106P, MG106X, MG110D, MG110H, MG110M, MG110P, MG110X, MG120D, MG120H, MG120M, MG120P, MG120X, MG210D, MG210H, MG210M, MG210P, MG210X, MG220D, MG220H, MG220M, MG220P, MG220X, MGC20H, MGC20X, MGC24H, MGC40H, MGC40M, MGC40P, MGC40X, MGS20D, MGS20H, MGS20M, MGS20P, MGS20X, MGS24D, MGS24H, MGS24M, MGS24P, MGS24X, MGS40D...(Other models you can see in the webshop)			

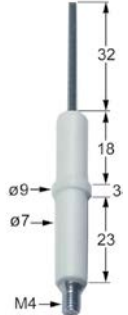
	1			
<b>GEV No.</b>	102476	<b>Ref. No.</b>	2617322	
<b>description</b>	glow plug conversion kit flange length 41mm flange width 20mm $\varnothing$ 11mm mounting distance 29mm cable length 60mm connection male faston 2.8mm total length 101mm L1 73mm L2 28mm 24V			

	1			
<b>GEV No.</b>	100701	<b>Ref. No.</b>	1949900	
<b>description</b>	ignition electrode connection M4 Qty 1 pcs			
<b>accessories for</b>	100701			
	<b>GEV No.</b>	100906	<b>Ref. No.</b>	1888100
	screw connection thread M10x1 for ignition electrode brass Qty 1 pcs WS 10			

	1			
<b>GEV No.</b>	100706	<b>Ref. No.</b>	1888300 MA1888300 MA224211	
<b>description</b>	ignition electrode connection M4 Qty 1 pcs			

2 gas components





1

<b>GEV No.</b>	102477	<b>Ref. No.</b>	2617321
<b>description</b>	ignition electrode conversion kit flange length 41mm flange width 20mm ø 11mm mounting distance 29mm cable length 60mm connection male faston 2.8mm total length 64mm L1 54mm L2 10mm 24V		



1

<b>GEV No.</b>	100707	<b>Ref. No.</b>	50102720 63050010 LAR50102720 LAR63050010
<b>description</b>	ignition electrode D1 ø 7mm D2 ø 9mm connection ø2.4mm L1 14mm L2 6mm BL1 18mm BL2 3mm BL3 23mm to clip Qty 1 pcs		
<b>For models:</b>	FG05, FG051M, FG051X, FG102M, FG102X, FG105M, FG105X, FG110M, FG110X, FG210M, FG210X, MG05, MG10, MG15, MG21, MG24, MG40, PG04, PG040M, PG040X, PG041M, PG041X, PG051M, PG051X, PG08, PG080M, PG080X, PG12, RG05, RG07, RG10, RG20, RG24, RG40		



1

<b>GEV No.</b>	104687	<b>Ref. No.</b>	63050080 63050090 LAR63050080 LAR63050090
<b>description</b>	ignition electrode flange length 17mm flange width 24mm D1 ø 9.5mm D2 ø 9.5mm L1 49mm BL1 64mm BL2 52mm connection male faston 2.8mm fixing dimensions 4.5mm flange		
<b>For models:</b>	MG102H, MG102M, MG102P, MG102T, MG201M, MG201P, MG202H, MG202M, MG202P, MG202T		

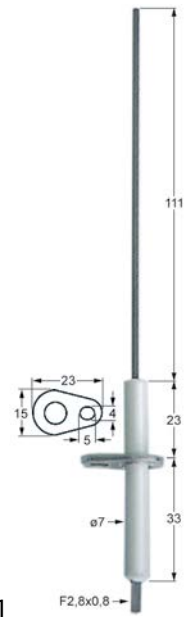

1

<b>GEV No.</b>	400172	<b>Ref. No.</b>	63050060 LA63050060 LAR63050060
<b>description</b>	ignition electrode flange length 23mm flange width 15mm D1 ø 7mm L1 111mm BL1 23mm BL2 33mm connection F2.8x0.8 with flange		
<b>For models:</b>	FG051M, FG051X, FG101M, FG101X, FG102M, FG102X, PG041M, PG041X, PG051X, PG081M, PG081X, PG101M, PG101X		



1

<b>GEV No.</b>	104695	<b>Ref. No.</b>	63050310 LAR63050310
<b>description</b>	ignition electrode flange length 23mm flange width 15mm D1 ø 7mm D2 ø 7mm L1 13mm L2 19mm L3 13mm BL1 31mm BL2 24mm connection M4 fixing dimensions 4x5mm flange		
<b>For models:</b>	CG106M, GC106M, GM106H, GM106M, GM106M+SC, GM106P, GV006H, GV006M, GV106H, GV106M, GV106M+SC, GV106P, MG106D, MG106M, MG106X, VG106D, VG106M, VG106X		

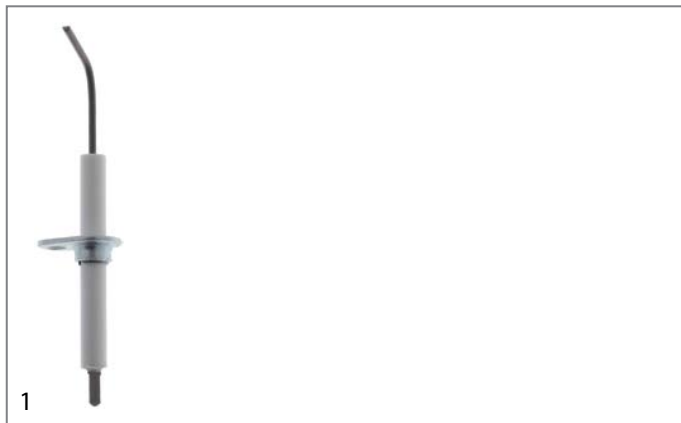

<b>GEV No.</b>	104686	<b>Ref. No.</b>	63050340 LAR63050340
<b>description</b>	ignition electrode flange length 23mm flange width 15mm D1 ø 7mm D2 ø 7mm L1 20mm L2 15mm BL1 22mm BL2 4mm BL3 28mm connection male faston 2.8mm		
<b>For models:</b>	CG110M, CG210M, GC010M, GC110M, GC210M, GM020H, GM020M, GM110H, GM110M, GM110M+SC, GM110P, GM210H, GM210M, GM210M+SC, GM210P, GV010H, GV010M, GV020H, GV110H, GV110M, GV110M+SC, GV110P, GV210H, GV210M, GV210M+SC, GV210P, MG110D, MG110M, MG110X, MG210D, MG210M, MG210X, VG110D, VG110M, VG110X, VG210D, VG210M, VG210X		



<b>GEV No.</b>	104685	<b>Ref. No.</b>	63050300 LAR63050300
<b>description</b>	ignition electrode flange length 23mm flange width 15mm D1 ø 7mm L1 15mm L2 12mm BL1 22mm BL2 31mm connection male faston 2.8mm fixing dimensions ø4mm with flange		
<b>For models:</b>	CG106M, GC106M, GM106H, GM106M, GM106M+SC, GM106P, GV006H, GV006M, GV106H, GV106M, GV106M+SC, GV106P, MG106D, MG106M, MG106X, VG106D, VG106M, VG106X		



<b>GEV No.</b>	104451	<b>Ref. No.</b>	63050350 LAR63050350
<b>description</b>	ignition electrode flange length 23mm flange width 15mm D1 ø 7mm L1 25mm L2 14mm L4 15mm BL1 22mm BL2 34mm		
<b>For models:</b>	CG110M, CG210M, GC010M, GC110M, GC210M, GM020H, GM020M, GM110H, GM110M, GM110M+SC, GM110P, GM210H, GM210M, GM210M+SC, GM210P, GV010H, GV010M, GV020H, GV110H, GV110M, GV110M+SC, GV110P, GV210H, GV210M, GV210M+SC, GV210P, MG110D, MG110M, MG110X, MG210D, MG210M, MG210X, VG110D, VG110M, VG110X, VG210D, VG210M, VG210X		

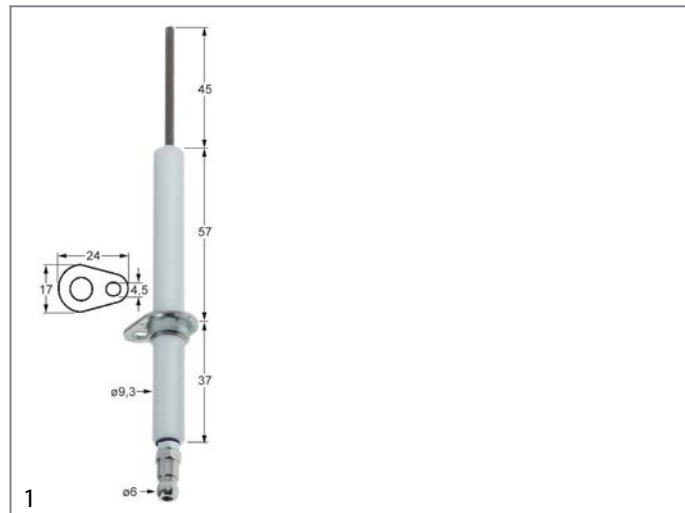

<b>GEV No.</b>	106756	<b>Ref. No.</b>	63050130 LAR63050130
<b>description</b>	ignition electrode flange length 24mm flange width 17mm D1 ø 9.3mm L1 45mm BL1 57mm BL2 37mm connection ø6 fixing dimensions ø4.5mm A1/B13/C2		
<b>For models:</b>	ABG064M, ABG074M, ABG084X, ABG104X, ABG156S, ARGN064, ARGN084, ARGN154, ARGS064, ARGS084, ARGS154, BPG044M, BPG044P, BPG054M, BPG054P, BPG064M, BPG064P, BPG074M, BPG074P, BPG084M, BPG084P, BPG104M, BPG104P, CVG061S, CVG061X, CVGN061, CVGS061, EPG056T, EPG086T, EPG156T, EPGV05T, EPGV08T, EPGV15T, GGMT06P, GGMT06T, GGMT07S, GGMT07X, GGMT10P, GGMT10S, GGMT10T, GGMT10X, GGMT20P, GGMT20S, GGMT20T, GGMT20X, GGMT21P, GGMT21S, GGMT21T, GGMT21X, GGMT40P..(Other models you can see in the webshop)		

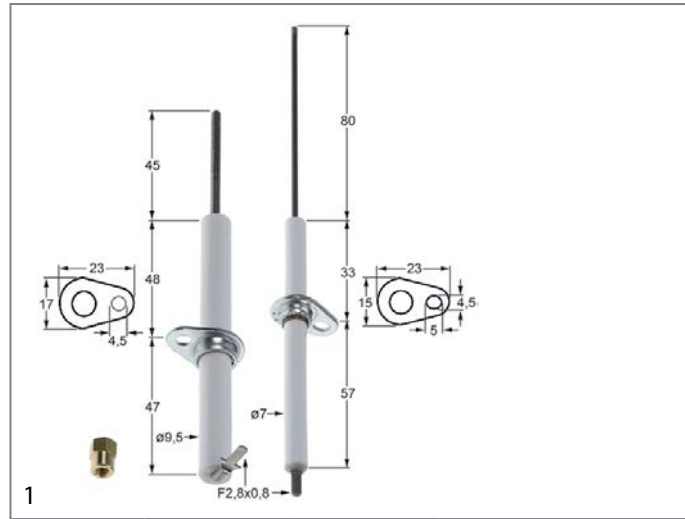

<b>GEV No.</b>	106525	<b>Ref. No.</b>	63050070 LAR63050070
<b>description</b>	ignition electrode set Qty 2 flange length 23mm flange width 15/17mm D1 ø 7/9.5mm L1 80/45mm BL1 33/48mm BL2 57/47mm connection F2.8x0.8 fixing dimensions ø4.5mm		
<b>For models:</b>	AVG05P, CG051M, CG071M, MACG05M, MACG07M, MG061D, MG061H, MG061M, MG061P, MG061T, MG101H, MG101M, MG101P, MG101T, MG201H, MG201M, MG201P, MG201T, VG051P, VG061D, VG061M, VG061P		

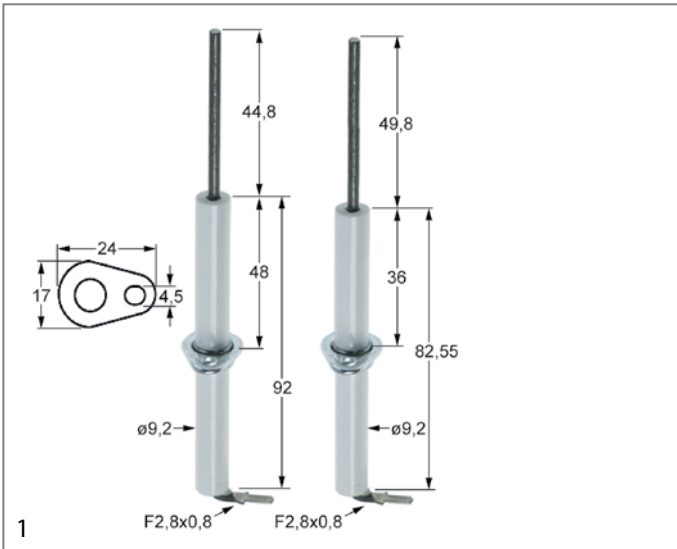

<b>GEV No.</b>	106647	<b>Ref. No.</b>	63050100 LAR63050100
<b>description</b>	ignition electrode set flange length 24mm flange width 17mm D1 ø 9.5mm L1 45mm BL1 48mm BL2 48mm connection male faston 2.8mm with screw connection 1x ignition 1x flame monitoring		
<b>For models:</b>	ACG10M, APG08M, APG10M, AVG10D, AVG20D, CG100M, CG200M, GGMT06P, GGMT06T, GGVT06P, GGVT06T, GMT06D, GMT06P, GMT20D, GMT20P, GVT06D, GVT06P, GVT20D, HMG061P, HMG061T, HMG061X, HVG061P, HVG061T, HVG061X, MACG10M, MACG20M, MG101D, MG101M, MG101P, MG101T, MG102D, MG102M, MG102P, MG102T, MG201D, MG201M, MG201P, MG201T, MG202D, MG202M, MG202P, MG202T, MGMT06D, MGMT06P, MGMT10D, MGMT10P, MGMT20D, MGMT20P, MGMT21D, MGMT21P...(Other models you can see in the webshop)		

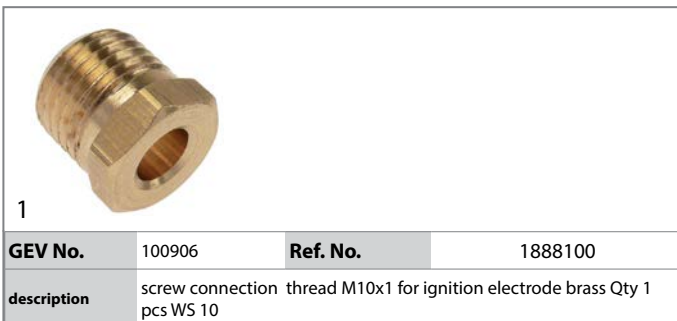

<b>GEV No.</b>	100906	<b>Ref. No.</b>	1888100
<b>description</b>	screw connection thread M10x1 for ignition electrode brass Qty 1 pcs WS 10		

## ignition cables

### pre-assembled cables

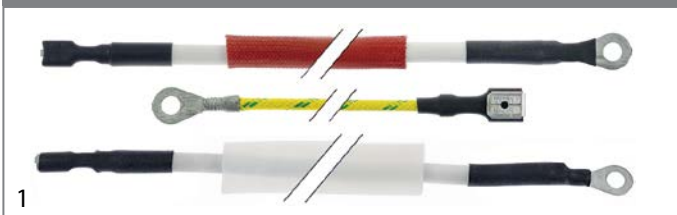

<b>GEV No.</b>	107856	<b>Ref. No.</b>	LAR66605810
<b>description</b>	ignition cable 3-piece L 1080mm		
<b>For models:</b>	GGMT40P, GGMT40T, GGVT40P, GGVT40T, HMG202P, HMG202T, HMG202X, HVG202P, HVG202T, HVG202X, MCG202M		

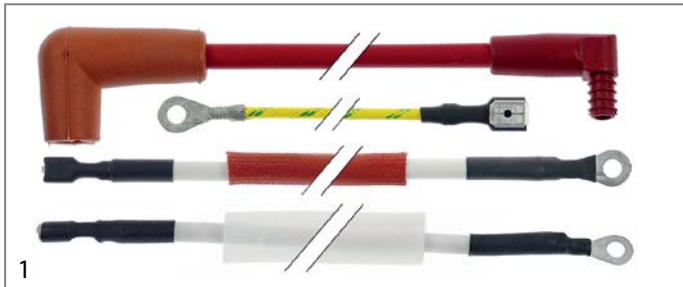

<b>GEV No.</b>	107857	<b>Ref. No.</b>	66605820 LAR66605820
<b>description</b>	ignition cable 4-piece L 520mm		
<b>For models:</b>	BPG044M, BPG044P, BPG054M, BPG054P, BPG064M, BPG064P, BPG074M, BPG074P, BPG084M, BPG084P, BPG104M, BPG104P, GGMT06P, GGMT06T, GGMT10P, GGMT10T, GGMT21P, GGMT21T, GGVT21P, GGVT21T, HMG061P, HMG061T, HMG061X, HMG101P, HMG101T, HMG101X, HMG201P, HMG201T, HMG201X, HVG101P, HVG101T, HVG101X, HVG201P, HVG201T, HVG201X, MCG051M, MCG071M, MCG101M, MCG102M, MCG201M, MMG071P, MMG101P, MMG102P, MVG051P, MVG071P, MVG101P, MVG102P		



<b>GEV No.</b>	100179	<b>Ref. No.</b>	50707360 66600400 LAR50707360 LAR66600400
<b>description</b>	ignition cable cable length 1200mm connection F2.8mm / ø2.4mm		
<b>For models:</b>	FG051M, FG051X, FG105M, FG105X, MG05, MG10, MG15, MG21, MG24, MG40, PG040M, PG040X, PG041M, PG041X, PG051M, PG051X, PG08, PG12, RG07, RG10, RG20, RG24, RG40		



<b>GEV No.</b>	102163	<b>Ref. No.</b>	50707370 66600410 LAR50707370 LAR66600410
<b>description</b>	ignition cable cable length 1500mm connection F2.8mm / ø2.4mm		
<b>For models:</b>	FG05, FG102M, FG102X, FG110M, FG110X, FG210M, FG210X, MG05, PG04, PG080M, PG080X, RG05		

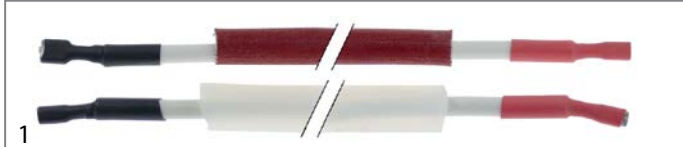

<b>GEV No.</b>	107851	<b>Ref. No.</b>	66110370 LAR66110370
<b>description</b>	ignition cable cable length 300mm set 2-piece		
<b>For models:</b>	ACG10M, APG08M, APG10M, AVG05P, AVG10D, AVG20D, CG051M, CG071M, CG100M, CG200M, HVG061P, HVG061T, HVG061X, MACG05M, MACG07M, MACG10M, MACG20M, MG061D, MG061M, MG061P, MG061T, MG101D, MG101M, MG101P, MG101T, MG201D, MG201M, MG201P, MG201T, PG084, PG104M, VG051P, VG061D, VG061M, VG061P, VG101D, VG101M, VG101P, VG201D, VG201M, VG201P		



<b>GEV No.</b>	100025	<b>Ref. No.</b>	100025 1950324 MA1950324
<b>description</b>	ignition cable cable length 600mm connection ø4mm / F6.3mm		





			
<b>GEV No.</b>	107853	<b>Ref. No.</b>	66605900 LAR66605900
<b>description</b>	ignition cable for combi-steamer set 2-piece L 800mm		
<b>For models:</b>	GC010M, GC106M, GC110M, GC210M, GM020H, GM020M, GM106H, GM106M, GM106M+SC, GM106P, GM110H, GM110M, GM110M+SC, GM110P, GM210H, GM210M, GM210M+SC, GM210P, GV006H, GV006M, GV010H, GV010M, GV020H, GV106H, GV106M, GV106M+SC, GV106P, GV110H, GV110M, GV110M+SC, GV110P, GV210H, GV210M, GV210M+SC, GV210P, VG106D, VG106M, VG106X, VG110D, VG110M, VG110X, VG210D, VG210M, VG210X		

			
<b>GEV No.</b>	107786	<b>Ref. No.</b>	66605120 66605150 LA66605120 LAR66605120 LAR66605150
<b>description</b>	ignition cable ID ø 7/4mm thicknessmm Qty 1m silicone permanent temperature°C t.max. 155°C flashover voltage 30000V red L 800mm		
<b>For models:</b>	ARGN064, ARGN084, ARGN154, ARGS064, ARGS084, ARGS154, GGMT07S, GGMT07X, GGMT10S, GGMT10X, GGMT21S, GGMT21X, GGVT07S, GGVT07X, GGVT10S, GGVT10X, GGVT21S, GGVT21X, KMG101S, KMG101X, KMG201S, KMG201X, KVG201X, LBG5071, LBG5101, LBG5201, LBGT071, LBGT101, LBGT201, LVGS071, LVGS101, LVGS201, LVGT071, LVGT101, LVGT201, NAGB071, NAGB071R, NAGB101, NAGB101R, NAGB201, NAGB201R, NAGV071, NAGV071R, NAGV101, NAGV101R, NAGV201, NAGV201R, SAGB071, SAGB071R, SAGB101... (Other models you can see in the webshop)		

			
<b>GEV No.</b>	107855	<b>Ref. No.</b>	66110380 66605840 LAR66110380 LAR66605840 R66110390 R66605910
<b>description</b>	ignition cable set 2-piece L 700mm		
<b>For models:</b>	FG101M, FG101X, FG102M, FG102X, MG102M, MG102P, MG102T, PG081M, PG081X, PG101M, PG101X		

			
<b>GEV No.</b>	107854	<b>Ref. No.</b>	66605800 LAR66605800 r66605800
<b>description</b>	ignition cable set 3-piece L 700mm		
<b>For models:</b>	GGMT06P, GGMT06T, GGMT10P, GGMT10T, GGMT20P, GGMT20T, GGMT21P, GGMT21T, GGVT06P, GGVT06T, GGVT10P, GGVT10T, GGVT20P, GGVT20T, HMG061P, HMG061T, HMG061X, HMG101P, HMG101T, HMG101X, HMG102P, HMG102T, HMG102X, HMG201P, HMG201T, HMG201X, HVG102P, HVG102T, HVG102X, MMG071P, MMG101P, MMG102P		

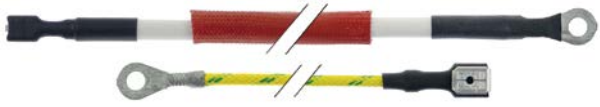
			
<b>GEV No.</b>	107787	<b>Ref. No.</b>	66605801 66605921 LAR66605801 LAR66605921
<b>description</b>	ignition cable set L 700mm		
<b>For models:</b>	ARGN064, ARGN084, ARGN154, ARGS064, ARGS084, ARGS154, GGMT07S, GGMT07X, GGMT10S, GGMT10X, GGMT20S, GGMT20X, GGMT21S, GGMT21X, GGMT40S, GGMT40X, GGVT07S, GGVT07X, GGVT10S, GGVT10X, GGVT21S, GGVT21X, KMG072S, KMG072X, KMG081S, KMG081X, KMG101S, KMG101X, KMG102S, KMG102X, KMG201S, KMG201X, KMG202S, KMG202X, KMG20X, KMG20S, KMG20X, KVG201X, LBG5071, LBG5072, LBG5101, LBG5102, LBG5201, LBG5202, LBGT071, LBGT072, LBGT101, LBGT102, LBGT201, LBGT202, LVGS071... (Other models you can see in the webshop)		

ignition units

			
<b>GEV No.</b>	104688	<b>Ref. No.</b>	65180270 LA65180270 LAR65180270
<b>description</b>	ignition unit outputs 1 220-240VAC dimensions 84x62x38mm mounting distance 59mm inlet F6.3x0.8 outlet ø4mm type TRK2-30PVD 69VA 50/60Hz 0.3A protection IP00		
<b>For models:</b>	ABG064M, ABG074M, ABG084X, ABG104X, ABG156S, ARGN064, ARGN084, ARGN154, ARGS064, ARGS084, ARGS154, BPG044M, BPG044P, BPG054M, BPG054P, BPG064M, BPG064P, BPG074M, BPG074P, BPG084M, BPG084P, BPG104M, BPG104P, CVG061S, CVG061X, EPG056T, EPG086T, EPG156T, EPGV05T, EPGV08T, EPGV15T, GGMT06P, GGMT06T, GGMT07S, GGMT07X, GGMT10P, GGMT10S, GGMT10T, GGMT10X, GGMT20P, GGMT20S, GGMT20T, GGMT20X, GGMT21P, GGMT21S, GGMT21T, GGMT21X, GGMT40P, GGMT40S, GGMT40T... (Other models you can see in the webshop)		

			
<b>GEV No.</b>	102485	<b>Ref. No.</b>	50102700 50102710 65180280 65180290 BN6A050100 LAR50102700 LAR50102710 LAR65180280 LAR65180290 MA2971400
<b>description</b>	ignition unit outputs 2 220-240VAC 0.6VA 50-60Hz		
<b>For models:</b>	FG05, FG051M, FG051X, FG102M, FG102X, FG105M, FG105X, FG110M, FG110X, FG210M, FG210X, MG05, MG10, MG15, MG21, MG24, MG40, PG04, PG040M, PG040X, PG041M, PG041X, PG051M, PG051X, PG08, PG080M, PG080X, PG12, RG05, RG07, RG10, RG20, RG24, RG40		

gas components



gas components

			
1			
<b>GEV No.</b>	101002	<b>Ref. No.</b>	0101193 2971400 65180310 LAR65180310 SIR0101193
<b>description</b>	ignition unit outputs 2 230VAC dimensions 88x23x34mm mounting distance 73mm inlet F6.3x0.8 outlet F2.8x0.8 0.6VA 50/60Hz		

## thermocouples

### plug-in thermocouples

### plug-in thermocouples standard

### with barrel socket ø6(6.5)mm

### thermocouples SIT

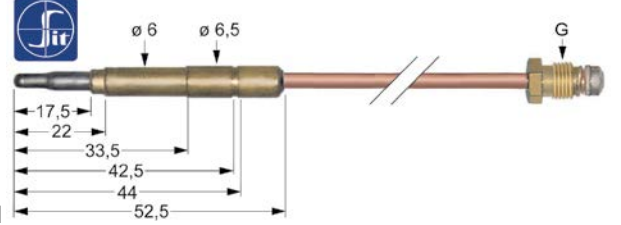
			
1			
<b>GEV No.</b>	107601	<b>Ref. No.</b>	1206400 MA1206400
<b>description</b>	thermocouple SIT M8x1 L 600mm plug connection ø6.0(6.5)mm		

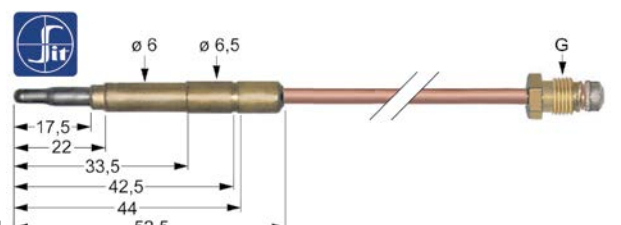
			
1			
<b>GEV No.</b>	107613	<b>Ref. No.</b>	263800
<b>description</b>	thermocouple SIT M9x1 L 1200mm plug connection ø6.0(6.5)mm		

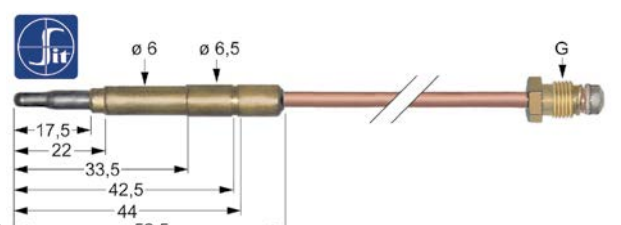
			
1			
<b>GEV No.</b>	107614	<b>Ref. No.</b>	0100818 50203240 63040030 LAR50203240 LAR63040030 SI0100818 SIR0100818
<b>description</b>	thermocouple SIT M9x1 L 1500mm plug connection ø6.0(6.5)mm		
<b>For models:</b>	FG102M, FG102X, FG110M, FG110X, FG210M, FG210X, MG05, MG10, MG15, MG21, MG24, MG40, PG08, PG080M, PG080X, PG12, RG07, RG10, RG20, RG24, RG40		

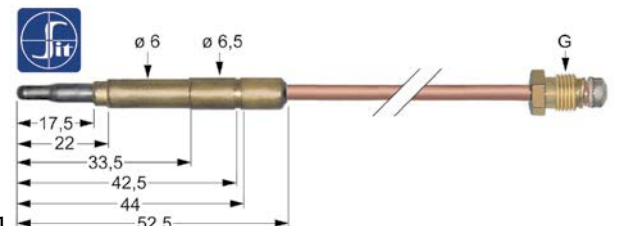
			
1			
<b>GEV No.</b>	107606	<b>Ref. No.</b>	1031500400
<b>description</b>	thermocouple SIT M9x1 L 320mm plug connection ø6.0(6.5)mm		

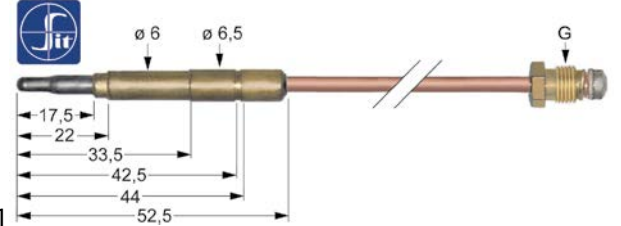
			
1			
<b>GEV No.</b>	107608	<b>Ref. No.</b>	1031504300 MA1031504300
<b>description</b>	thermocouple SIT M9x1 L 500mm plug connection ø6.0(6.5)mm		

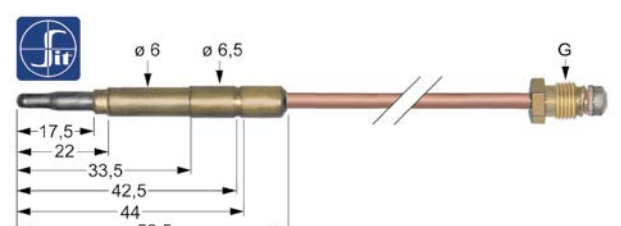
			
1			
<b>GEV No.</b>	107611	<b>Ref. No.</b>	50203230 63040020 LAR50203230 LAR63040020
<b>description</b>	thermocouple SIT M9x1 L 850mm plug connection ø6.0(6.5)mm		
<b>For models:</b>	FG05, FG051M, FG051X, FG105M, FG105X, MG05, MG24, MG40, PG04, PG040M, PG040X, PG041M, PG041X, PG051M, PG051X, RG05		

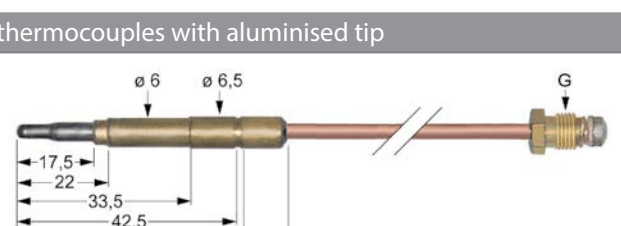
			
1			
<b>GEV No.</b>	102034	<b>Ref. No.</b>	1033027800
<b>description</b>	thermocouple M8x1 L 600mm plug connection ø6.0(6.5)mm		

			
1			
<b>GEV No.</b>	102034	<b>Ref. No.</b>	1033027800
<b>description</b>	thermocouple M8x1 L 600mm plug connection ø6.0(6.5)mm		



thermopiles

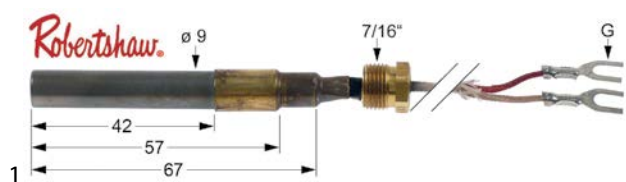

<b>GEV No.</b>	102116	<b>Ref. No.</b>	1870712
<b>description</b>	thermopile ROBERTSHAW L 900mm probe $\varnothing$ 9mm probe L 57mm 250-750mV screw connection 7/16"		

accessories

displays



<b>GEV No.</b>	101414	<b>Ref. No.</b>	50202830 65350010 LAR50202830 LAR65350010
<b>description</b>	display soldering connection		
<b>For models:</b>	MG15, MG21, MG24, MG40, PG12, RG20, RG24, RG40		

interrupters



<b>GEV No.</b>	101265	<b>Ref. No.</b>	0100835 50203130 63040210 LAR50203130 LAR63040210 SIR0100835
<b>description</b>	interrupter thread M9x1		
<b>For models:</b>	FG051M, FG051X, FG102M, FG102X, FG105M, FG105X, FG110M, FG110X, FG210M, FG210X, MG15, MG21, MG24, MG40, PG040M, PG040X, PG041M, PG041X, PG051M, PG051X, PG080M, PG080X, PG12, RG20, RG24, RG40		

gas burners

bar burners

bar burners



<b>GEV No.</b>	106885	<b>Ref. No.</b>	63010080 LA63010080 LAR63010080
<b>description</b>	bar burner		



<b>GEV No.</b>	108098	<b>Ref. No.</b>	63010070 63016520 LA63010070 LAR63010070 LAR63016520
<b>description</b>	bar burner 1-row L 440mm $\varnothing$ 50mm flange width 57mm flange length 57mm MG110, VG110		
<b>For models:</b>	GC010M, GC110M, GM110H, GM110M, GM110M+SC, GM110P, GV010H, GV010M, GV110H, GV110M, GV110M+SC, GV110P		



<b>GEV No.</b>	105543	<b>Ref. No.</b>	63010010 LA63010010 LAR63010010
<b>description</b>	bar burner 1-row $\varnothing$ 40mm Wmm Hmm L 420mm flange width 43mm flange length 43mm bain marie		



<b>GEV No.</b>	104216	<b>Ref. No.</b>	63010120 LAR63010120
<b>description</b>	bar burner 1-row $\varnothing$ 50mm Wmm Hmm L 485mm		

gas components





			
1			
<b>GEV No.</b>	105855	<b>Ref. No.</b>	63015010 LAR63015010
<b>description</b>	bar burner 2 row L 485mm W 160mm ø 90mm H 40mm combi-steamer MG106		
<b>For models:</b>	MG106L, MG106S, MG106T		

			
1			
<b>GEV No.</b>	105848	<b>Ref. No.</b>	63014980 LAR63014980
<b>description</b>	bar burner 2 row L 490mm W 145mm ø 39mm H 90mm combi-steamer MG105, VG105		
<b>For models:</b>	MG105L, MG105S, VG105S		

			
1			
<b>GEV No.</b>	105836	<b>Ref. No.</b>	50204220 63015470 LAR50204220 LAR63015470
<b>description</b>	bar burner 2 row L 500mm W 164mm ø 50mm H 85mm combi-steamer MG05-21		
<b>For models:</b>	MG05, MG10, MG15, MG21		
<b>spare parts for</b>	105836		
	<b>GEV No.</b>	104633	<b>Ref. No.</b>
			63010110 LA63010110 LAR63010110 R63010110
	bar burner ø 50mm Wmm Hmm L 434mm flange width 57mm flange length 57mm		

			
1			
<b>GEV No.</b>	105856	<b>Ref. No.</b>	63015030 LAR63015030
<b>description</b>	bar burner 2 row L 500mm W 240mm ø 50mm H 110mm combi-steamer MG110		
<b>For models:</b>	MG110L, MG110S, MG110T		

			
1			
<b>GEV No.</b>	105845	<b>Ref. No.</b>	50204260 63015280 63015300 LAR50204260 LAR63015280 LAR63015300
<b>description</b>	bar burner 2 row L 550mm W 165mm ø 50mm H 85mm combi-steamer MG21		
<b>For models:</b>	FG101M, FG101X, FG110M, FG110X, MG21, PG080M, PG080X, PG081M, PG081X, PG101M, PG101X		

			
1			
<b>GEV No.</b>	106944	<b>Ref. No.</b>	63010060 LAR63010060
<b>description</b>	bar burner ø 40mm Wmm Hmm L 425mm flange width 43mm flange length 43mm		

			
1			
<b>GEV No.</b>	107774	<b>Ref. No.</b>	63010090 LA63010090 LAR63010090
<b>description</b>	bar burner ø 50mm L 495mm flange width 58mm flange length 58mm		

			
1			
<b>GEV No.</b>	104633	<b>Ref. No.</b>	63010110 LA63010110 LAR63010110
<b>description</b>	bar burner ø 50mm Wmm Hmm L 434mm flange width 57mm flange length 57mm		



forced air burners



1

<b>GEV No.</b>	104309	<b>Ref. No.</b>	63140020 LAR63140020
<b>description</b>	gasket L 106mm W 100mm H 3mm 4 holes		
<b>For models:</b>	ACG10M, APG08M, APG10M, AVG10D, AVG20D, CG100M, CG200M, GMT20D, GMT20P, GVT20D, MACG10M, MACG20M, MG101D, MG101H, MG101M, MG101P, MG101T, MG102D, MG102H, MG102M, MG102P, MG102T, MG201D, MG201H, MG201M, MG201P, MG201T, MG202D, MG202H, MG202M, MG202P, MG202T, MGMT10D, MGMT10P, MGMT20D, MGMT20P, MGMT21D, MGMT21P, MGMT40D, MGMT40P, MGVT10D, MGVT10P, MGVT20D, MGVT20P, MGVT21D, MGVT21P, MGVT40D, MGVT40P, PG084, PG104M...(Other models you can see in the webshop)		



1

<b>GEV No.</b>	104314	<b>Ref. No.</b>	63140060 LA63140060 LAR63140060
<b>description</b>	gasket L 108mm W 103mm H 3mm 6 holes		
<b>For models:</b>	ACG10M, APG08M, APG10M, AVG10D, AVG20D, CG100M, CG200M, GGMT10P, GGMT10S, GGMT10T, GGMT10X, GGMT20P, GGMT20S, GGMT20T, GGMT20X, GGMT21P, GGMT21S, GGMT21T, GGMT21X, GGMT40P, GGMT40S, GGMT40T, GGMT40X, GMT20D, GMT20P, GVT20D, HMG101P, HMG101T, HMG101X, HMG102P, HMG102T, HMG102X, HMG201P, HMG201T, HMG201X, HMG202P, HMG202T, HMG202X, KMG072S, KMG072X, KMG101S, KMG101X, KMG102S, KMG102X, KMG201S, KMG201X, KMG202S, KMG202X, KMGA20S, KMGA20X...(Other models you can see in the webshop)		



1

<b>GEV No.</b>	108149	<b>Ref. No.</b>	63120030 63120040 LA63120030 LAR63120020 LAR63120030 LAR63120040
<b>description</b>	venturi for combi-steamer LAINOX		
<b>For models:</b>	ABG064M, ABG074M, ABG084X, ABG104X, ABG156S, ARGN064, ARGN084, ARGN154, ARGS064, ARGS084, ARGS154, AVG05P, AVG20D, BPG044M, BPG044P, BPG054M, BPG054P, BPG064M, BPG064P, BPG074M, BPG074P, BPG084M, BPG084P, BPG104M, BPG104P, CG051M, CG071M, CG200M, CVG061S, CVG061X, EPG056T, EPG086T, EPG156T, EPGV05T, EPGV08T, EPGV15T, GGMT06P, GGMT06T, GGMT07S, GGMT07X, GGMT10P, GGMT10S, GGMT10T, GGMT10X, GGMT20P, GGMT20S, GGMT20T, GGMT20X, GGMT21P, GGMT21S...(Other models you can see in the webshop)		

accessories

gaskets



1

<b>GEV No.</b>	510254	<b>Ref. No.</b>	63140000 LA63140000 LAR63140000
<b>description</b>	gasket L 77mm W 70mm H 3mm hole ø 7mm hole distance 55x60mm graphite for gas burner		
<b>For models:</b>	AVG05P, CG051M, CG071M, GMT06D, GMT06P, GVT06D, GVT06P, MACG05M, MACG07M, MG061D, MG061H, MG061M, MG061P, MG061T, MGMT06D, MGMT06P, MGVT06D, MGVT06P, VG051P, VG061D, VG061M, VG061P		

gas nozzles

main nozzles

gas nozzles M10x1



1

<b>GEV No.</b>	100639	<b>Ref. No.</b>	63200070 LAR63200070 SIR0102019
<b>description</b>	gas injector thread M10x1 WS 11 bore ø 1.25mm inner peaked		

pilot burner nozzles

pilot burner nozzles SIT

100 series



1

<b>GEV No.</b>	100245	<b>Ref. No.</b>	1415100
<b>description</b>	pilot burner nozzle LPG code 20 bore ø 0.2mm Qty 1 pcs thread M8x0.75		



1

<b>GEV No.</b>	107171	<b>Ref. No.</b>	1842300
<b>description</b>	pilot burner nozzle SIT natural/liquid gas bore ø 0.25mm Qty 1 pcs		

140/150 series





1

<b>GEV No.</b>	100204	<b>Ref. No.</b>	1888000 MA1888000
<b>description</b>	pilot burner nozzle SIT LPG code 14 bore ø 0.18/0.20mm Qty 1 pcs suitable for 140 series		



			
1			
<b>GEV No.</b>	100207	<b>Ref. No.</b>	MA1887800
<b>description</b>	pilot burner nozzle SIT natural gas code 27 bore ø 0.40/0.38mm suitable for SIT 140 series		



160 series			
			
1			
<b>GEV No.</b>	107172	<b>Ref. No.</b>	1874700
<b>description</b>	pilot burner nozzle SIT LPG code 25 Qty 1 pcs		



			
1			
<b>GEV No.</b>	107650	<b>Ref. No.</b>	100802
<b>description</b>	pilot burner nozzle SIT LPG code 30 Qty 1 pcs		

			
1			
<b>GEV No.</b>	107174	<b>Ref. No.</b>	1033719700
<b>description</b>	pilot burner nozzle SIT natural gas code 41 Qty 1 pcs		



## screw connections

### olives

			
1			
<b>GEV No.</b>	101248	<b>Ref. No.</b>	417810
<b>description</b>	olive for pipe ø 12mm L 9.5mm brass Qty 1 pcs suitable for PEL		
<b>accessories for</b>	101248		
	<b>GEV No.</b>	101251	<b>Ref. No.</b> —
union nut thread M20x1.5 for pipe ø 12mm			

			
1			
<b>GEV No.</b>	101273	<b>Ref. No.</b>	MA417810
<b>description</b>	olive for pipe ø 12mm L 9.5mm brass Qty 1 pcs suitable for universal		
<b>accessories for</b>	101273		
	<b>GEV No.</b>	100944	<b>Ref. No.</b> —
union nut thread M18x1.5 for pipe ø 12mm			
	<b>GEV No.</b>	101276	<b>Ref. No.</b> 459300
union screw thread 3/8" tube ø 12mm Qty 1 pcs			

			
1			
<b>GEV No.</b>	100897	<b>Ref. No.</b>	1887800
<b>description</b>	olive for pipe ø 4mm Qty 1 pcs for pilot burner		

			
1			
<b>GEV No.</b>	101286	<b>Ref. No.</b>	62070023 LA62070023 LAR62070023
<b>description</b>	olive ID ø 6mm Qty 1 pcs		
<b>For models:</b>	AREN064, AREN084, AREN154, ARES154, ARGN064, ARGN084, ARGN154, ARGS064, ARGS084, ARGS154, CBEN061, CBES061, CKES10, CME061S, CME061X, CVE061S, CVE061X, CVEN061, CVES061, CVG061S, CVG061X, GEMT07S, GEMT07X, GEMT10S, GEMT10X, GEMT20S, GEMT20X, GEMT21S, GEMT21X, GEMT40S, GEMT40X, GEVT07S, GEVT07X, GEVT10S, GEVT10X, GEVT20S, GEVT20X, GEVT21S, GEVT21X, GEVT40S, GEVT40X, GGMT07S, GGMT07X, GGMT10S, GGMT10X, GGMT20S, GGMT20X, GGMT21S, GGMT21X, GGMT40S...(Other models you can see in the webshop)		
<b>accessories for</b>	101286		
	<b>GEV No.</b>	100909	<b>Ref. No.</b> 62060223 LA62060223 LAR62060223 R62060223
union screw thread M10x1 for pipe ø 6mm Qty 1 pcs			
	<b>GEV No.</b>	101464	<b>Ref. No.</b> —
union nut thread M12x1 for pipe ø 6mm			



### union screws

			
1			
<b>GEV No.</b>	100904	<b>Ref. No.</b>	1394700
<b>description</b>	locking screw M10x1 for pipe ø 4mm Qty 1 pcs		

			
1			
<b>GEV No.</b>	100906	<b>Ref. No.</b>	1888100
<b>description</b>	screw connection thread M10x1 for ignition electrode brass Qty 1 pcs WS 10		

			
1			
<b>GEV No.</b>	100907	<b>Ref. No.</b>	1891700
<b>description</b>	screw connection thread M10x1 Qty 1 pcs type SEF 1 ømm for thermocouple		



			
1			
<b>GEV No.</b>	100908	<b>Ref. No.</b>	1888400
<b>description</b>	union screw thread M10x1 for pipe ø 4mm Qty 1 pcs		
<b>accessories for</b>	100908		
	<b>GEV No.</b>	100897	<b>Ref. No.</b> 1887800
	olive for pipe ø 4mm Qty 1 pcs for pilot burner		
	<b>GEV No.</b>	101246	<b>Ref. No.</b> —
	olive for pipe ø 4mm Qty 1 pcs		
	<b>GEV No.</b>	101280	<b>Ref. No.</b> —
	olive for pipe ø 4mm Qty 1 pcs		
	<b>GEV No.</b>	101282	<b>Ref. No.</b> —
	olive for pipe ø 4mm L 7.4mm Qty 1 pcs		

			
1			
<b>GEV No.</b>	100909	<b>Ref. No.</b>	62060223 LA62060223 LAR62060223
<b>description</b>	union screw thread M10x1 for pipe ø 6mm Qty 1 pcs		
<b>For models:</b>	AREN064, AREN084, AREN154, ARES154, ARGN064, ARGN084, ARGN154, ARGS064, ARGS084, ARGS154, CBEN061, CBES061, CKES10, CME061S, CME061X, CVE061S, CVE061X, CVEN061, CVES061, CVG061S, CVG061X, GEMT07S, GEMT07X, GEMT10S, GEMT10X, GEMT20S, GEMT20X, GEMT21S, GEMT21X, GEMT40S, GEMT40X, GEVT07S, GEVT07X, GEVT10S, GEVT10X, GEVT20S, GEVT20X, GEVT21S, GEVT21X, GEVT40S, GEVT40X, GGMT07S, GGMT07X, GGMT10S, GGMT10X, GGMT20S, GGMT20X, GGMT21S, GGMT21X, GGMT40S...(Other models you can see in the webshop)		
<b>accessories for</b>	100909		
	<b>GEV No.</b>	100898	<b>Ref. No.</b> —
	olive for pipe ø 6mm Qty 1 pcs for pilot burner		
	<b>GEV No.</b>	101286	<b>Ref. No.</b> 62070023 LA62070023 LAR62070023 R62070023
	olive ID ø 6mm Qty 1 pcs		
	<b>GEV No.</b>	101287	<b>Ref. No.</b> —
	olive for pipe ø 6mm Qty 1 pcs		
	<b>GEV No.</b>	101288	<b>Ref. No.</b> —
	olive for pipe ø 6mm L 6mm aluminium Qty 1 pcs ED ø 8.5mm		

pressure switches

			
1			
<b>GEV No.</b>	541073	<b>Ref. No.</b>	63070010 LA63070010 LAR63070010
<b>description</b>	pressure control ø 45mm pressure range adjustable 5-20mbar pressure connection vertical gas technology connection 1/4" pressure connection ø 1/4"mm		
<b>For models:</b>	ABG064M, ABG074M, ABG084X, ABG104X, ABG156S, ACG10M, APG08M, APG10M, ARGN064, ARGN084, ARGN154, ARGS064, ARGS084, ARGS154, AVG05P, AVG10D, AVG20D, BPG044M, BPG044P, BPG054M, BPG054P, BPG064M, BPG064P, BPG074M, BPG074P, BPG084M, BPG084P, BPG104M, BPG104P, CG051M, CG071M, CG100M, CG105M, CG106M, CG110M, CG200M, CG210M, CGC24M, CGC40M, CGS24M, CGS40M, CVG061S, CVG061X, CVG105H, CVG105M, CVGN061, CVGS061, EPG056T, EPG086T, EPG156T...(Other models you can see in the webshop)		

equipmentspecific units

for convection ovens/combi-steamers

drain units

drip rails

			
1			
<b>GEV No.</b>	691961	<b>Ref. No.</b>	69180000 69180010 LA69180010 LAR69180000 LAR69180010
<b>description</b>	drain unit L 90mm edition since 2009		
<b>For models:</b>	ABG064M, ABG074M, ABG084X, ABG104X, AREN064, AREN084, ARES064, ARES084, ARGN064, ARGN084, ARGS064, ARGS084, CBEN061, CBES061, CKES10, CME061S, CME061X, COEN026, COEN061, COEN101, COES026, COES061, COES101, CVE061S, CVE061X, CVEN061, CVES061, CVG061S, CVG061X, CVGN061, CVGS061, EMT06D, EMT20P, EPE056T, EPE086T, EPEV05T, EPEV08T, EPG056T, EPG086T, EPGV05T, EPGV08T, EVT06D, EVT20D, GEMT06P, GEMT06T, GEMT07S, GEMT07X, GEMT10P, GEMT10S, GEMT10T...(Other models you can see in the webshop)		

2 gas components



1

<b>GEV No.</b>	698946	<b>Ref. No.</b>	69180220 LAR69180220
<b>description</b>	drip rail L 557mm plastic W 33.5mm		
<b>For models:</b>	AREN064, AREN084, ARES064, ARES084, ARGN064, ARGN084, ARGS064, ARGS084, GEMT07S, GEMT07X, GEMT10S, GEMT10X, GEVT07S, GEVT07X, GEVT10S, GEVT10X, GGMT07S, GGMT07X, GGMT10S, GGMT10X, GGV07S, GGV07X, GGV10S, GGV10X, LBES071, LBES101, LBET071, LBET101, LBS071, LBS101, LBGT071, LBGT101, LVES071, LVES101, LVET071, LVET101, LVGS071, LVGS101, LVGT071, LVGT101, NAE071, NAE071R, NAE101, NAE101R, NAEV071, NAEV071R, NAEV101, NAEV101R, NAGB071, NAGB071R... (Other models you can see in the webshop)		



1

<b>GEV No.</b>	692707	<b>Ref. No.</b>	69180150 LAR69180150
<b>description</b>	drip rail L 690mm plastic W 40mm for combi-steamer hole ø 6mm		
<b>For models:</b>	HME061P, HME061T, HME061X, HMG061P, HMG061T, HMG061X, HVE061P, HVE061T, HVE061X, HVG061P, HVG061T, HVG061X, KME081S, KME081X, KME101S, KME101X, KMG081S, KMG081X, KM-G101S, KMG101X, KVE081S, KVE081X, KVE101S, KVE101X, KVG081S, KVG081X, KVG101X		



1

<b>GEV No.</b>	698947	<b>Ref. No.</b>	69180230 LAR69180230
<b>description</b>	drip rail L 797mm plastic W 33.5mm		
<b>For models:</b>	GEMT20S, GEMT20X, GEVT20S, GEVT20X, GGMT20S, GGMT20X, GGV20S, GGV20X, LBES072, LBES102, LBET072, LBET102, LBS072, LBS102, LBGT072, LBGT102, LVES072, LVES102, LVET072, LVET102, LVGS072, LVGS102, LVGT072, LVGT102, NAE072R, NAE102, NAE102R, NAE072, NAE072R, NAEV072, NAEV072R, NAEV102, NAEV102R, NAGB072, NAGB072R, NAGB102, NAGB102R, NAGV072, NAGV072R, NAGV102, NAGV102R, SAE072, SAE072R, SAE102, SAE102R, SAEV072, SAEV072R, SAEV102, SAEV102R, SAGB072, SAGB072R... (Other models you can see in the webshop)		



1

<b>GEV No.</b>	694606	<b>Ref. No.</b>	11200520 LAR11200520
<b>description</b>	drip rail L 90mm edition from 2000 until 2009		
<b>For models:</b>	ME061H, ME061M, ME061P, ME061T, ME101H, ME101M, ME101P, ME101T, ME102H, ME102M, ME102P, ME102T, MG061H, MG061M, MG061P, MG061T, MG101H, MG101M, MG101P, MG101T, MG102H, MG102M, MG102P, MG102T, PEV08T		



1

<b>GEV No.</b>	692808	<b>Ref. No.</b>	69180160 LAR69180160
<b>description</b>	drip rail with screw connection L 730mm plastic W 32mm for combi-steamer		
<b>For models:</b>	HME061P, HME061T, HME061X, HMG061P, HMG061T, HMG061X, HVE061P, HVE061T, HVE061X, HVG061P, HVG061T, HVG061X, KME081S, KME081X, KME101S, KME101X, KMG081S, KMG081X, KM-G101S, KMG101X, KVE081S, KVE081X, KVE101S, KVE101X, KVG081S, KVG081X, KVG101X		



1

<b>GEV No.</b>	692807	<b>Ref. No.</b>	69180170 LAR69180170
<b>description</b>	drip rail with screw connection L 750mm plastic W 70mm for combi-steamer		
<b>For models:</b>	EPE056T, EPE086T, EPEV05T, EPEV08T, EPG056T, EPG086T, EPGV05T, EPGV08T, GEMT20P, GEMT20T, GEVT20P, GEVT20T, GEVT20X, GG-MT20P, GGMT20T, GGV20P, GGV20T, HME101P, HME101S, HME101T, HME101X, HME102P, HME102S, HME102T, HME102X, HMG101P, HMG101T, HMG101X, HMG102P, HMG102T, HMG102X, HVE101P, HVE101S, HVE101T, HVE101X, HVE102P, HVE102S, HVE102T, HVE102X, HVG101P, HVG101T, HVG101X, HVG102P, HVG102T, HVG102X, KME072S, KME072X, KME102X, KMG072S, KMG072X... (Other models you can see in the webshop)		



accessories



1

<b>GEV No.</b>	698949	<b>Ref. No.</b>	69040030 LAR69040030
<b>description</b>	cover ED ø 80mm H 8mm		
<b>For models:</b>	NAEB071, NAEB071R, NAEB072R, NAEB101, NAEB101R, NAEB102, NAEB102R, NAEB072, NAGB071, NAGB071R, NAGB072, NAGB072R, NAGB101, NAGB101R, NAGB102, NAGB102R, SAEB071, SAEB072, SAEB101, SAEB102, SAGB071, SAGB072, SAGB101, SAGB102		



1

<b>GEV No.</b>	698945	<b>Ref. No.</b>	69040040 LA69040040 LAR69040040
<b>description</b>	cover ED ø 90mm H 51mm		
<b>For models:</b>	AREN064, AREN084, ARES064, ARES084, ARGN064, ARGN084, ARGS064, ARGS084, NAEB071, NAEB071R, NAEB072R, NAEB101, NAEB101R, NAEB102, NAEB102R, NAEB072, NAEV071, NAEV071R, NAEV072, NAEV072R, NAEV101, NAEV101R, NAEV102, NAEV102R, NAGB071, NAGB071R, NAGB072, NAGB072R, NAGB101, NAGB101R, NAGB102, NAGB102R, NAGV071, NAGV071R, NAGV072, NAGV072R, NAGV101, NAGV101R, NAGV102, NAGV102R, SAEB071, SAEB072, SAEB101, SAEB102, SAEV071, SAEV072, SAEV101, SAEV102, SAGB071, SAGB072...(Other models you can see in the webshop)		



1

<b>GEV No.</b>	698944	<b>Ref. No.</b>	69040060 LA69040060 LAR69040060
<b>description</b>	drain filter ED ø 85mm H 41mm		
<b>For models:</b>	AREN064, AREN084, ARES064, ARES084, ARGN064, ARGN084, ARGS064, ARGS084, NAEB071, NAEB071R, NAEB072R, NAEB101, NAEB101R, NAEB102, NAEB102R, NAEB072, NAEV071, NAEV071R, NAEV072, NAEV072R, NAEV101, NAEV101R, NAEV102, NAEV102R, NAGB071, NAGB071R, NAGB072, NAGB072R, NAGB101, NAGB101R, NAGB102, NAGB102R, NAGV071, NAGV071R, NAGV072, NAGV072R, NAGV101, NAGV101R, NAGV102, NAGV102R, SAEB071, SAEB072, SAEB101, SAEB102, SAEV071, SAEV072, SAEV101, SAEV102, SAGB071, SAGB072...(Other models you can see in the webshop)		

drain valves



1

<b>GEV No.</b>	694977	<b>Ref. No.</b>	LA62280038 R62280038
<b>description</b>	drain pipe angled 90° polypropylene DN50 for combi-steamer		
<b>For models:</b>	AREN064, AREN084, AREN154, ARES064, ARES084, ARES154, ARGN064, ARGN084, ARGN154, ARGS064, ARGS084, ARGS154, CVE024S, CVE024X, GEMT07S, GEMT07X, GEMT10S, GEMT10X, GEMT20S, GEMT20X, GEMT21S, GEMT21X, GEMT40S, GEMT40X, GEVT07S, GEVT07X, GEVT10S, GEVT10X, GEVT20S, GEVT20X, GEVT21S, GEVT21X, GEVT40S, GEVT40X, GGMT07S, GGMT07X, GGMT10S, GGMT10X, GGMT20S, GGMT20X, GGMT21S, GGMT21X, GGMT40S, GGMT40X, GGV07S, GGV07X, GGV10S, GGV10X, GGV20S, GGV20X...(Other models you can see in the webshop)		

antennas



1

<b>GEV No.</b>	698951	<b>Ref. No.</b>	65302560 LA65302560 LAR65302560
<b>description</b>	stirrer L 105mm ø 10mm		
<b>For models:</b>	AREN064, AREN084, AREN154, ARGN064, ARGN084, ARGN154, NAEB071, NAEB071R, NAEB072R, NAEB101, NAEB101R, NAEB102, NAEB102R, NAEB201, NAEB201R, NAEB202, NAEB202R, NAEV071, NAEV071R, NAEV072, NAEV072R, NAEV101, NAEV101R, NAEV102, NAEV102R, NAEV201, NAEV201R, NAEV202, NAEV202R, NAGB071, NAGB071R, NAGB072, NAGB072R, NAGB101, NAGB101R, NAGB102, NAGB102R, NAGB201, NAGB201R, NAGB202, NAGB202R, NAGV071, NAGV071R, NAGV072, NAGV072R, NAGV101, NAGV101R, NAGV102, NAGV102R...(Other models you can see in the webshop)		

mechanical components, equipment accessories

## bushes



1

<b>GEV No.</b>	699451	<b>Ref. No.</b>	70080010 LAR7008001 LAR70080010
<b>description</b>	bush for steam generator ID ø 60mm ED ø 76mm L 70mm ceramic suitable for combi-steamer		
<b>For models:</b>	GMT20D, GMT20P, MG101D, MG101H, MG101M, MG101P, MG101T, MG102D, MG102H, MG102M, MG102P, MG102T, MG201D, MG201H, MG201M, MG201P, MG201T, MG202D, MG202H, MG202M, MG202P, MG202T, MGMT10D, MGMT10P, MGMT20D, MGMT20P, MGMT21D, MGMT21P, MGMT40D, MGMT40P		

## injection nozzles



1

<b>GEV No.</b>	691278	<b>Ref. No.</b>	58006130 58006140 LA58006130 LAR58006130 LAR58006140
<b>description</b>	injection nozzle bore ø 1mm for combi-steamer		
<b>For models:</b>	AME07D, AME07P, AME10D, AVE07D, AVE07P, AVE10D, AVE10P, AVG05P, AVG10D, AVG20D, BPG044M, BPG044P, BPG054M, BPG054P, EMT06D, EMT10D, EMT20P, EMT21P, EPE056T, EPE086T, EPE156T, EPEV05T, EPEV08T, EPEV15T, EPG056T, EPG086T, EPG156T, EPGV05T, EPGV08T, EPGV15T, EVEA20S, EVT06D, EVT06P, EVT10P, EVT20D, GEMT06P, GEMT06T, GEMT10P, GEMT10T, GEMT20P, GEMT20T, GEMT21P, GEMT21T, GEMT40P, GEMT40T, GEVT06P, GEVT06S, GEVT06T, GEVT10P, GEVT10T...(Other models you can see in the webshop)		



1

<b>GEV No.</b>	698950	<b>Ref. No.</b>	LA69040050 LAR69040050
<b>description</b>	injection nozzle bore ø 2mm D1 ø 27mm D2 ø 5.6mm plastic		
<b>For models:</b>	AREN064, AREN084, ARES064, ARES084, ARGN064, ARGN084, ARGS064, ARGS084, NAEB071, NAEB071R, NAEB072R, NAEB101, NAEB101R, NAEB102, NAEB102R, NAEBO72, NAEV071, NAEV071R, NAEV072, NAEV072R, NAEV101, NAEV101R, NAEV102, NAEV102R, NAGB071, NAGB071R, NAGB072, NAGB072R, NAGB101, NAGB101R, NAGB102, NAGB102R, NAGV071, NAGV071R, NAGV072, NAGV072R, NAGV101, NAGV101R, NAGV102, NAGV102R, SAEB071, SAEB072, SAEB101, SAEB102, SAEV071, SAEV072, SAEV101, SAEV102, SAGB071, SAGB072...(Other models you can see in the webshop)		



1

<b>GEV No.</b>	692326	<b>Ref. No.</b>	58006080 LAR58006080
<b>description</b>	injection nozzle bore ø 2mm L 33mm WS 14 brass for combi-steamer T1: M10x1 T2: M10x1		
<b>For models:</b>	EM020M, EM210H, EM210M, EM210M+SC, EM210P, EV020M, EV210H, EV210M, EV210M+SC, EV210P, FEI102P, FME201SX, GM020H, GM020M, GM210H, GM210M, GM210M+SC, GM210P, GV020H, GV210H, GV210M, GV210M+SC, GV210P, ME120D, ME120H, ME120M, ME120P, ME120X, ME210D, ME210H, ME210M, ME210P, ME210X, ME220D, ME220H, ME220M, ME220P, ME220X, MEC20H, MEC20P, MEC20X, MEC24H, MEC40H, MEC40M, MEC40P, MED40D, MEK21H, MES20D, MES20H, MES20M...(Other models you can see in the webshop)		

## injection pipes



1

<b>GEV No.</b>	696767	<b>Ref. No.</b>	10206480 LA10206480 LAR10206480
<b>description</b>	extension U-shape for injection pipe ED ø 8/12mm ID ø 6/8mm		
<b>For models:</b>	CE110M, CE210M, CEC40M, CES24M, CES40M, CG110M, CG210M, CGC24M, CGC40M, CGS24M, CGS40M, EC020M, EC110M, EC210M, EM010H, EM010M+SC, EM020M, EM110H, EM110M, EM110M+SC, EM110P, EM210H, EM210M, EM210M+SC, EM210P, EV010H, EV010M, EV010P, EV020M, EV110H, EV110M, EV110M+SC, EV110P, EV210H, EV210M, EV210M+SC, EV210P, FEI102P, FME101AX, FME201SX, GC010M, GC020M, GC110M, GC210M, GM020H, GM020M, GM110H, GM110M, GM110M+SC, GM110P...(Other models you can see in the webshop)		



1

<b>GEV No.</b>	692819	<b>Ref. No.</b>	11201980 LA11201980 LAR11201980
<b>description</b>	injection pipe for combi-steamer ED ø 8mm ID ø 5.5mm L 170mm W 115mm		
<b>For models:</b>	AVG10D, AVG20D, EPG086T, GVT20D, HVG101P, HVG101T, HVG101X, MGVT10D, MGVT10P, MGVT20D, MGVT20P, MGVT40D, MGVT40P, NAGB102R, NAGV101R, NAGV102R, NAGV201R, NAGV202R, SAGB102R, SAGV101R, SAGV102R, SAGV201R, SAGV202R, VG101D, VG101M, VG101P, VG102D, VG102M, VG102P, VG201D, VG201M, VG201P, VG202D, VG202M, VG202P		







			
1			
<b>GEV No.</b>	692821	<b>Ref. No.</b>	18200540 LA18200540 LAR18200540
<b>description</b>	injection pipe for combi-steamer H 75mm ED ø 8mm ID ø 6mm L 105mm		
<b>For models:</b>	ABE044M, ABE054M, ACE04M, ACE05M, AVG05P, BPE044M, BPE044P, BPE054M, BPE054P, BPG044M, BPG044P, BPG054M, BPG054P, CE041M, CE051M, CG051M, MACE04M, MACE05M, MACG05M, MCE042M, MCE051M, MCG051M, MVE042P, MVE051P, MVG051P, PE044M, PE054M, SCE051M, SVE042S, SVE051S, VE042P, VE051P, VE055P, VG051P		

			
1			
<b>GEV No.</b>	692832	<b>Ref. No.</b>	11201990 LA11201990 LAR11201990
<b>description</b>	injection pipe for combi-steamer U-shape ED ø 8mm ID ø 6mm		
<b>For models:</b>	ABG156S, ACG10M, APG08M, APG10M, BPG084M, BPG084P, BPG104M, BPG104P, CG100M, CG200M, EPE056T, EPEV05T, EPG056T, EPG156T, EPGV05T, GEMT21P, GEMT21T, GEMT40P, GEMT40T, GEVT21P, GEVT21T, GEVT40P, GEVT40T, GGMT20P, GGMT20T, GGMT21P, GGMT21T, GGMT40P, GGMT40T, GGVT20P, GGVT20T, GGVT21P, GGVT21T, GGVT40P, GGVT40T, GMT20D, GMT20P, HME202P, HME202S, HME202T, HME202X, HMG101P, HMG101T, HMG101X, HMG102P, HMG102T, HMG102X, HMG201P, HMG201T, HMG201X... (Other models you can see in the webshop)		

			
1			
<b>GEV No.</b>	694318	<b>Ref. No.</b>	10206540 LA10206540 LAR10206540
<b>description</b>	injection pipe L1 66mm L2 49mm tube ø 8mm mounting distance 36mm		
<b>For models:</b>	CE106M, CE110M, CE210M, CEC40M, CES24M, CES40M, CG106M, CG110M, CG210M, CGC24M, CGC40M, CGS24M, CGS40M, EC020M, EC106M, EC110M, EC210M, EM006H, EM006M+SC, EM010H, EM010M+SC, EM020M, EM106H, EM106M, EM106M+SC, EM106P, EM110H, EM110M, EM110M+SC, EM110P, EM210H, EM210M, EM210M+SC, EM210P, EV006M, EV006P, EV010H, EV010M, EV010P, EV020M, EV106H, EV106M, EV106M+SC, EV106P, EV110H, EV110M, EV110M+SC, EV110P, EV210H, EV210M... (Other models you can see in the webshop)		

			
1			
<b>GEV No.</b>	692820	<b>Ref. No.</b>	11200650 LAR11200650
<b>description</b>	injection pipe with holder for combi-steamer ED ø 8mm ID ø 6mm L 150mm H 75mm		
<b>For models:</b>	AME07D, AME07P, APE06, APE07, AVE07D, AVE07P, BPE064M, BPE064P, BPE074M, BPE074P, BPG064M, BPG064P, BPG074M, BPG074P, CE071M, CG071M, EMT06D, EVT06D, EVT06P, GEMT06P, GEMT06T, GEVT06P, GEVT06S, GEVT06T, GGMT06P, GGMT06T, GGVT06P, GGVT06T, GMT06D, GMT06P, GVT06D, GVT06P, HME061P, HME061T, HME061X, HMG061P, HMG061T, HMG061X, HVE061P, HVE061T, HVE061X, HVG061P, HVG061T, HVG061X, MACE07M, MACG07M, MCE071M, MCG071M, ME061D, ME061H... (Other models you can see in the webshop)		

spare parts and accessories

			
1			
<b>GEV No.</b>	692828	<b>Ref. No.</b>	17400540 LA17400540 LAR17400540
<b>description</b>	door hinge upper for combi-steamer L 63mm W 35mm H 31mm		
<b>For models:</b>	A05PES, A05PES+UM, A05RES, A05RES+UM, A08PES, A08PES+UM, A08RES, A08RES+UM, A10PES, A10PES+UM, A10RES, A10RES+UM, REC023M		

			
1			
<b>GEV No.</b>	692835	<b>Ref. No.</b>	58003110 LA58003110 LAR58003110
<b>description</b>	pin for air baffle combi-steamer L 38mm ø 7mm		
<b>For models:</b>	AREN064, AREN084, AREN154, ARES064, ARES084, ARES154, ARGN064, ARGN084, ARGN154, ARGS064, ARGS084, ARGS154, CKES10, EPE056T, EPEV05T, EPG056T, EPGV05T, GEMT06P, GEMT06T, GEMT07S, GEMT07X, GEMT10P, GEMT10S, GEMT10T, GEMT10X, GEMT20S, GEMT20X, GEMT21P, GEMT21S, GEMT21T, GEMT21X, GEMT40S, GEMT40X, GEVT06P, GEVT06S, GEVT06T, GEVT07S, GEVT07X, GEVT10P, GEVT10S, GEVT10T, GEVT10X, GEVT20S, GEVT20X, GEVT21P, GEVT21S, GEVT21T, GEVT21X, GEVT40S, GEVT40X... (Other models you can see in the webshop)		



1

<b>GEV No.</b>	694979	<b>Ref. No.</b>	LA69180110 LAR69180110
<b>description</b>	thermostatic steam trap for combi-steamer plastic		
<b>For models:</b>	GEMT20S, GEMT20X, GEVT20S, GEVT20X, GGMT20S, GGMT20X, GGVT20S, GGVT20X, KME072S, KME072X, KME102X, KMG072S, KMG072X, KMG102S, KMG102X, KVE072S, KVE072X, KVE102S, KVE102X, KVG072X, KVG102X, LBES072, LBES102, LBET072, LBET102, LBGS072, LBGS102, LBGT072, LBGT102, LVES072, LVES102, LVET072, LVET102, LVGS072, LVGS102, LVGT072, LVGT102, NAE072R, NAE102, NAE102R, NAE072, NAEV072, NAEV072R, NAEV102, NAEV102R, NAGB072, NAGB072R, NAGB102, NAGB102R, NAGV072... (Other models you can see in the webshop)		



1

<b>GEV No.</b>	694981	<b>Ref. No.</b>	69180100 LA69180100 R69180100
<b>description</b>	thermostatic steam trap for combi-steamer plastic		
<b>For models:</b>	KME081S, KME081X, KME101S, KME101X, KME201S, KME201X, KMEA20S, KMEA20X, KMG081S, KMG081X, KMG101S, KMG101X, KMG201S, KMG201X, KMGA20S, KMGA20X, KVE081S, KVE081X, KVE101S, KVE101X, KVE201S, KVE201X, KVEA20S, KVEA20X, KVG081X, KVG101X, KVG201X, KVGA20X		

## filters



1

<b>GEV No.</b>	691269	<b>Ref. No.</b>	18200260 LAR18200260
<b>description</b>	drain filter ø 43mm		
<b>For models:</b>	ACE04M, CE041M, MACE04M, MCE042M, MVE042P, SCE051M, SVE042S, SVE051S, VE042P		



1

<b>GEV No.</b>	691270	<b>Ref. No.</b>	02200280 10201700 50606790 LA10201700 LAR02200280 LAR10201700
<b>description</b>	drain filter ø 76mm		
<b>For models:</b>	ABE084S, ABE104S, ABG064M, ABG074M, ABG084X, ABG104X, AME07D, AME07P, APE06, APE07, AVE07D, AVE07P, BPE064M, BPE064P, BPE074M, BPE074P, BPG064M, BPG064P, BPG074M, BPG074P, CBEN061, CBES061, CE071M, CE106M, CE110M, CEV026S, CEV026X, CEV061S, CEV061X, CEV101S, CEV101X, CG071M, CG106M, CG110M, CKES10, CME061S, CME061X, COEN026, COEN061, COEN101, COES026, COES061, COES101, CVE024S, CVE024X, CVE061S, CVE061X, CVEN061, CVES061, CVG061S... (Other models you can see in the webshop)		



1

<b>GEV No.</b>	691271	<b>Ref. No.</b>	10201710 10201720 LA10201710 LAR10201710 LAR10201720
<b>description</b>	drain filter ø 87mm		
<b>For models:</b>	ABE156X, ABG156S, ACE10M, ACG10M, AME10D, APG08M, APG10M, AREN084, AREN154, ARES064, ARES084, ARES154, ARGN064, ARGN084, ARGN154, ARGS064, ARGS084, ARGS154, AVE10D, AVE10P, AVG10D, AVG20D, BPE084M, BPE084P, BPE104M, BPE104P, BPG084M, BPG084P, BPG104M, BPG104P, CE100M, CE200M, CE210M, CEC40M, CES24M, CES40M, CG100M, CG200M, CG210M, CGC24M, CGC40M, CGS24M, CGS40M, EMT06D, EMT10D, EMT20P, EMT21P, EPE156T, EPEV05T, EPEV15T... (Other models you can see in the webshop)		

## glass panels





1

<b>GEV No.</b>	696395	<b>Ref. No.</b>	99600638 LAR99600638
<b>description</b>	glass panel L 800mm W 591mm thickness 5mm for combi-steamer		

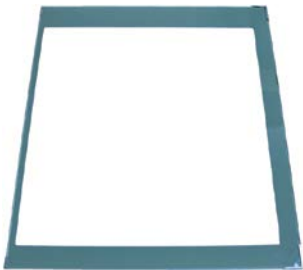



			
1			
<b>GEV No.</b>	696396	<b>Ref. No.</b>	11100140 LAR11100140
<b>description</b>	glass panel L 860mm W 730mm thickness 6mm mounting pos. inner for combi-steamer		
<b>For models:</b>	EMT20P, EPE086T, EPEV08T, EPG086T, EPGV08T, EVT20D, GEMT20P, GEMT20T, GEVT20P, GEVT20T, GEVT20X, GGMT20P, GGMT20T, GGVT20P, GGVT20T, GMT20D, GMT20P, GVT20D, HME101P, HME101S, HME101T, HME101X, HME102P, HME102S, HME102T, HME102X, HMG101P, HMG101T, HMG101X, HMG102P, HMG102T, HMG102X, HVE101P, HVE101S, HVE101T, HVE101X, HVE102P, HVE102S, HVE102T, HVE102X, HVG101P, HVG101T, HVG101X, HVG102P, HVG102T, HVG102X, ME101D, ME101H, ME101M, ME101P...(Other models you can see in the webshop)		

<b>cleaning system</b>			
<b>nozzles</b>			
			
1			
<b>GEV No.</b>	550864	<b>Ref. No.</b>	62210042 LAR62210042
<b>description</b>	nozzle flow rate 0.56l/min for combi-steamer		
<b>For models:</b>	EMT20P, EMT21P, EPE056T, EPE086T, EPE156T, EPEV05T, EPEV08T, EPEV15T, EPG056T, EPG086T, EPG156T, EPGV05T, EPGV08T, EPGV15T, GEMT06P, GEMT06T, GEMT10P, GEMT10T, GEMT20P, GEMT20T, GEMT21P, GEMT21T, GEMT40P, GEMT40T, GEVT06P, GEVT06T, GEVT10P, GEVT10T, GEVT20P, GEVT20T, GEVT21P, GEVT21T, GEVT40P, GEVT40T, GGMT06P, GGMT06T, GGMT10P, GGMT10T, GGMT20P, GGMT20T, GGMT21P, GGMT21T, GGMT40P, GGMT40T, GGVT06P, GGVT06T, GGVT10P, GGVT10T, GGVT20P, GGVT20T...(Other models you can see in the webshop)		

			
1			
<b>GEV No.</b>	550865	<b>Ref. No.</b>	62210032 LAR62210032
<b>description</b>	nozzle flow rate 1.3l/min for combi-steamer		
<b>For models:</b>	EMT20P, EMT21P, EPE056T, EPE086T, EPE156T, EPEV05T, EPEV08T, EPEV15T, EPG056T, EPG086T, EPG156T, EPGV05T, EPGV08T, EPGV15T, GEMT06P, GEMT06T, GEMT10P, GEMT10T, GEMT20P, GEMT20T, GEMT21P, GEMT21T, GEMT40P, GEMT40T, GEVT06P, GEVT06T, GEVT10P, GEVT10T, GEVT20P, GEVT20T, GEVT21P, GEVT21T, GEVT40P, GEVT40T, GGMT06P, GGMT06T, GGMT10P, GGMT10T, GGMT20P, GGMT20T, GGMT21P, GGMT21T, GGMT40P, GGMT40T, GGVT06P, GGVT06T, GGVT10P, GGVT10T, GGVT20P, GGVT20T...(Other models you can see in the webshop)		

<b>coupling bushings</b>			
			
1			
<b>GEV No.</b>	550863	<b>Ref. No.</b>	58004980 LA58004980 LAR58004980
<b>description</b>	bush for wash arm		
<b>For models:</b>	EMT20P, EMT21P, EPE056T, EPE086T, EPE156T, EPEV05T, EPEV08T, EPEV15T, EPG056T, EPG086T, EPG156T, EPGV05T, EPGV08T, EPGV15T, GEMT06P, GEMT06T, GEMT10P, GEMT10T, GEMT20P, GEMT20T, GEMT21P, GEMT21T, GEMT40P, GEMT40T, GEVT06P, GEVT06T, GEVT10P, GEVT10T, GEVT20P, GEVT20T, GEVT21P, GEVT21T, GEVT40P, GEVT40T, GGMT06P, GGMT06T, GGMT10P, GGMT10T, GGMT20P, GGMT20T, GGMT21P, GGMT21T, GGMT40P, GGMT40T, GGVT06P, GGVT06T, GGVT10P, GGVT10T, GGVT20P, GGVT20T...(Other models you can see in the webshop)		

<b>cleaning arms</b>			
			
1			
<b>GEV No.</b>	542409	<b>Ref. No.</b>	58007020 L58007020 LAR58007020
<b>description</b>	mounting flange with gasket for wash arm suitable for LAINOX combi-steamer		
<b>For models:</b>	ABE084S, ABE104S, ABE156X, ABG084X, ABG104X, ABG156S, AREN064, AREN084, AREN154, ARES064, ARES084, ARES154, ARGN064, ARGN084, ARGN154, ARGS064, ARGS084, ARGS154, CBEN061, CBES061, CEV026S, CEV026X, CEV061S, CEV061X, CEV101S, CEV101X, CKES10, CME061S, CME061X, COEN026, COEN061, COEN101, COES026, COES061, COES101, CVE024S, CVE024X, CVE061S, CVE061X, CVEN061, CVES061, CVG061S, CVG061X, CVGN061, CVGS061, EVEA20S, GEMT07S, GEMT07X, GEMT10S, GEMT10X...(Other models you can see in the webshop)		

<b>hoses</b>			
			
1			
<b>GEV No.</b>	694953	<b>Ref. No.</b>	80150040 80150040A LAR70070080 LAR80150040 LAR80150040A
<b>description</b>	hose ID ø 13mm ED ø 23mm L 1mm EPDM blue/white t.max. 120°C for combi-steamer		
<b>For models:</b>	CEV026S, CEV026X, CEV061S, CEV061X, CEV101S, CEV101X, CVE024S, CVE024X, NAEB201R, NAEB202R, NAEV071, NAEV201R, NAEV202R, NAGB201R, NAGB202R, NAGV201R, NAGV202R, REV051S, REV071S, REV101S, RGV051S, RGV071S, RGV101S, SAEB101, SAEB201R, SAEB202R, SAEV201R, SAEV202R, SAGB201R, SAGB202R, SAGV201R, SAGV202R		

mechanical components, equipment accessories

## screw connections



1

<b>GEV No.</b>	542411	<b>Ref. No.</b>	LA58007050 LAR58007050
<b>description</b>	bolt for fixing wash arm M12x1 L 110mm		
<b>For models:</b>	CBEN061, CBES061, CME061S, CME061X, CVE061S, CVE061X, CVEN061, CVES061, CVG061S, CVG061X, CVGN061, CVGS061, ICET051, ICET071, ICET101, ICGT051, ICGT071, ICGT101, KME061S, KME061X, KVE061S, KVE061X, KVG061X, REV051S, REV071S, REV101S, RGV051S, RGV071S, RGV101S, SVE051S		



1

<b>GEV No.</b>	542412	<b>Ref. No.</b>	58007000 LA58007000 LAR58007000
<b>description</b>	bolt for flange wash arm L 50mm M12x1 suitable for combi-steamer		
<b>For models:</b>	ABE084S, ABE104S, ABE156X, ABG084X, ABG104X, ABG156S, AREN064, AREN084, AREN154, ARES064, ARES084, ARES154, ARGN064, ARGN084, ARGN154, ARGS064, ARGS084, ARGS154, CEV026S, CEV026X, CEV061S, CEV061X, CEV101S, CEV101X, CKES10, CME061S, CME061X, CVE024S, CVE024X, CVE061S, CVE061X, CVG061S, CVG061X, EVEA20S, GEMT07S, GEMT07X, GEMT10S, GEMT10X, GEMT20S, GEMT20X, GEMT21S, GEMT21X, GEMT40S, GEMT40X, GEVT06S, GEVT07S, GEVT07X, GEVT10S, GEVT10X, GEVT20S...(Other models you can see in the webshop)		



1

<b>GEV No.</b>	361814	<b>Ref. No.</b>	62020108 LA62020108 LAR62020108
<b>description</b>	double nipple 1/8" L 20mm plastic WS 11		
<b>For models:</b>	ME061T, ME101T, ME102T, ME201T, ME202T, MG061T, MG101T, MG102T, MG201T, MG202T		

## pipes



1

<b>GEV No.</b>	520970	<b>Ref. No.</b>	62180022 LAR62180022
<b>description</b>	drain pipe flexible L 135mm ID ø 18mm ED ø 27.5mm connection 3/4" ET - 3/4" IT SS for combi-steamer		
<b>For models:</b>	EMT21P, GEMT40S, GEMT40X, GGMT06P, GGMT06T, GGMT10P, GGMT10T, GGMT20P, GGMT20T, GGMT21P, GGMT21T, GGMT40P, GGMT40T, GGVT10P, GGVT10T, GMT06D, GMT06P, HMG061P, HMG061T, HMG061X, HMG101P, HMG101T, HMG101X, HMG102P, HMG102T, HMG102X, HMG201P, HMG201T, HMG201X, HMG202P, HMG202T, HMG202X, KME072S, KME072X, KME202S, KME202X, KMG101S, KMG101X, KMG102S, KMG102X, KMG201S, KMG201X, KMGA20S, KMGA20X, ME201D, ME201H, ME201M, ME201P, ME201T, MEMT21D...(Other models you can see in the webshop)		

## hoses



1

<b>GEV No.</b>	530904	<b>Ref. No.</b>	77700056 LAR77700056
<b>description</b>	hose ID ø 30mm ED ø 36mm L 3000mm for combi-steamer		
<b>For models:</b>	ABG064M, ABG074M, ABG084X, ABG104X, ABG156S, ARGN064, ARGN084, ARGS064, ARGS084, BPG044M, BPG044P, BPG054M, BPG054P, BPG064M, BPG064P, BPG074M, BPG074P, BPG084M, BPG084P, BPG104M, BPG104P, CVG061S, CVG061X, CVGN061, CVGS061, EPG056T, EPG086T, EPG156T, EPGV05T, EPGV08T, EPGV15T, GGMT06P, GGMT06T, GGMT07S, GGMT07X, GGMT10P, GGMT10S, GGMT10T, GGMT10X, GGMT20P, GGMT20S, GGMT20T, GGMT20X, GGMT21P, GGMT21S, GGMT21T, GGMT21X, GGMT40P, GGMT40S, GGMT40T...(Other models you can see in the webshop)		



1

<b>GEV No.</b>	520534	<b>Ref. No.</b>	70060040 LA70060040 LAR70060040
<b>description</b>	hose ID ø 50mm ED ø 58mm L 50mm silicone Qty 1 for combi-steamer thickness 4mm		
<b>For models:</b>	ABE084S, ABE104S, ABE156X, ABG084X, ABG104X, ABG156S, AREN064, AREN084, AREN154, ARES064, ARES084, ARES154, ARGN064, ARGN084, ARGN154, ARGS064, ARGS084, ARGS154, CE106M, CE110M, CE210M, CG106M, CG110M, CG210M, CKES10, EMT21P, EPE056T, EPE086T, EPE156T, EPEV05T, EPEV08T, EPEV15T, EPG056T, EPG086T, EPG156T, EPGV05T, EPGV08T, EPGV15T, FE051M, FE051X, FE101M, FE101X, FE105M, FE105X, FE110M, FE110X, FE1102P, FG051M, FG051X, FG101M...(Other models you can see in the webshop)		



1

<b>GEV No.</b>	530901	<b>Ref. No.</b>	70060050 LA70060050 R70060050
<b>description</b>	hose ID ø 54mm ED ø 60mm L 50mm for combi-steamer		
<b>For models:</b>	FE102M, FE102X, FE210M, FE210X, FG102M, FG102X, FG210M, FG210X, GEMT20P, GEMT20S, GEMT20T, GEMT20X, GEMT40P, GEMT40S, GEMT40T, GEMT40X, GEVT20P, GEVT20S, GEVT20T, GEVT20X, GEVT40P, GEVT40S, GEVT40T, GEVT40X, GGMT20S, GGMT20X, GGMT40P, GGMT40S, GGMT40T, GGMT40X, GGVT20S, GGVT20X, GGVT40P, GGVT40S, GGVT40T, GGVT40X, HME102P, HME102S, HME102T, HME102X, HME202P, HME202S, HME202T, HME202X, HMG202P, HMG202T, HMG202X, HVE102P, HVE102S, HVE102T...(Other models you can see in the webshop)		



service kits

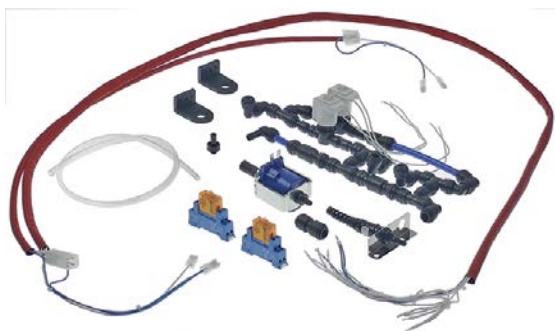

1

<b>GEV No.</b>	512503	<b>Ref. No.</b>	62300028 LAR62300028
<b>description</b>	backflow preventer kit		
<b>For models:</b>	EMT20P, EPE056T, EPE086T, EPE156T, EPEV05T, EPEV08T, EPEV15T, EPG056T, EPG086T, EPG156T, EPGV05T, EPGV08T, EPGV15T, GEMT06P, GEMT06T, GEMT10P, GEMT10T, GEMT20P, GEMT20T, GEVT06P, GEVT06T, GEVT10P, GEVT10T, GEVT20P, GEVT20T, GGMT06P, GGMT06T, GGMT10P, GGMT10T, GGMT20P, GGMT20T, GGV06P, GGV06T, GGV10P, GGV10T, GGV20P, GGV20T, GMT06P, GMT20P, GSE201N, HME061P, HME061T, HME061X, HME101P, HME101S, HME101T, HME101X, HME102P, HME102S, HME102T...(Other models you can see in the webshop)		



1

<b>GEV No.</b>	530902	<b>Ref. No.</b>	99000160 LA99000160 LAR99000160
<b>description</b>	flange kit for washing arms suitable for combi-steamer LAINOX		
<b>For models:</b>	COEN061		



1

<b>GEV No.</b>	699468	<b>Ref. No.</b>	58003100 LAR58003100
<b>description</b>	mounting set for air baffle 4-piece		
<b>For models:</b>	CE106M, CE110M, CE210M, CEC40M, CES24M, CES40M, CG106M, CG110M, CG210M, CGC24M, CGC40M, CGS24M, CGS40M, EMT06D, EMT10D, EMT20P, EMT21P, EPE086T, EPE156T, EPEV08T, EPEV15T, EPG086T, EPG156T, EPGV08T, EPGV15T, EVT06D, EVT06P, EVT10P, EVT20D, FE102P, GEMT20P, GEMT20T, GEMT40P, GEMT40T, GEVT20P, GEVT20T, GEVT20X, GEVT40P, GEVT40T, GGMT20P, GGMT20T, GG-MT40P, GGMT40T, GGV20P, GGV20T, GGV40P, GGV40T, GMT06D, GMT06P, GMT20D...(Other models you can see in the webshop)		

drip water trays



1

<b>GEV No.</b>	699854	<b>Ref. No.</b>	69180190 LAR69180190
<b>description</b>	drip tray L 520mm W 35mm H 70mm		
<b>For models:</b>	CKES10, GEMT06P, GEMT06T, GEMT10P, GEMT10T, GEVT06P, GEVT06S, GEVT06T, GEVT10P, GEVT10T, GGMT06P, GGMT06T, GGMT10P, GG-MT10T, GGV06P, GGV06T, GGV10P, GGV10T		



1

<b>GEV No.</b>	699242	<b>Ref. No.</b>	69180200 LAR69180200
<b>description</b>	drip tray L 576mm W 32mm H 51mm		
<b>For models:</b>	CKES10, GEMT06P, GEMT06T, GEMT10P, GEMT10T, GEVT06P, GEVT06S, GEVT06T, GEVT10P, GEVT10T, GGMT06P, GGMT06T, GGMT10P, GG-MT10T, GGV06P, GGV06T, GGV10P, GGV10T		

doors



1

<b>GEV No.</b>	690585	<b>Ref. No.</b>	2011212
<b>description</b>	bush for door mechanism L 35mm ED ø 36mm int. ø 1 31mm int. ø 2 13mm mounting distance 28mm brass		
<b>For models:</b>	VE102MX		



1

<b>GEV No.</b>	692325	<b>Ref. No.</b>	71010010 LAR71010010
<b>description</b>	glass panel W 514mm H 314mm thickness 4mm for hot air oven Qty 1 pcs		
<b>For models:</b>	FE105M, FE105X, FG105M, FG105X, PE040M, PE040X, PG040M, PG040X		





## door mechanics

## holders



1

<b>GEV No.</b>	691272	<b>Ref. No.</b>	18203910 LAR18203910
<b>description</b>	bracket for glass plate mounting pos. lower		
<b>For models:</b>	ACE10M, ACG10M, AME07D, AME07P, AME10D, APE06, APE07, APG08M, APG10M, AVE07D, AVE07P, AVE10D, AVE10P, AVG10D, AVG20D, BPE064M, BPE064P, BPE074M, BPE074P, BPE084M, BPE084P, BPE104M, BPE104P, BPG064M, BPG064P, BPG074M, BPG074P, BPG084M, BPG084P, BPG104M, BPG104P, CE071M, CE100M, CE200M, CG071M, CG100M, CG200M, MACE07M, MACE10M, MACE20M, MACG07M, MACG10M, MACG20M, MCE071M, MCE101M, MCE102M, MCG071M, MCG101M, MCG102M, MME071P...(Other models you can see in the webshop)		



1

<b>GEV No.</b>	691273	<b>Ref. No.</b>	18203920 LAR18203920
<b>description</b>	bracket for glass plate mounting pos. upper		
<b>For models:</b>	ACE10M, ACG10M, AME07D, AME07P, AME10D, APE06, APE07, APG08M, APG10M, AVE07D, AVE07P, AVE10D, AVE10P, AVG10D, AVG20D, BPE064M, BPE064P, BPE074M, BPE074P, BPE084M, BPE084P, BPE104M, BPE104P, BPG064M, BPG064P, BPG074M, BPG074P, BPG084M, BPG084P, BPG104M, BPG104P, CE071M, CE100M, CE200M, CG071M, CG100M, CG200M, MACE07M, MACE10M, MACE20M, MACG07M, MACG10M, MACG20M, MCE071M, MCE101M, MCE102M, MCG071M, MCG101M, MCG102M, MME071P...(Other models you can see in the webshop)		

## miscellaneous



1

<b>GEV No.</b>	690585	<b>Ref. No.</b>	2011212
<b>description</b>	bush for door mechanism L 35mm ED ø 36mm int. ø 21.3mm mounting distance 28mm brass		
<b>For models:</b>	VE102MX		



1

<b>GEV No.</b>	691298	<b>Ref. No.</b>	18100000 LAR18100000
<b>description</b>	oven door complete		
<b>For models:</b>	ACE04M, CE041M, MACE04M, MCE042M, MVE042P, VE042P		



1

<b>GEV No.</b>	692836	<b>Ref. No.</b>	11401360 LA11401360 LAR11401360
<b>description</b>	protective plate lower for glass plate combi-steamer H 8mm W 8mm		
<b>For models:</b>	AME07D, EMT06D, EMT10D, EMT20P, EPE056T, EPE086T, EPEV05T, EPEV08T, EPG056T, EPG086T, EPGV05T, EPGV08T, EVT06D, EVT06P, EVT10P, EVT20D, GEMT06P, GEMT06T, GEMT10P, GEMT10T, GEMT20P, GEMT20T, GEVT06P, GEVT06S, GEVT06T, GEVT10P, GEVT10T, GEVT20P, GEVT20T, GEVT20X, GGMT06P, GGMT06T, GGMT10P, GGMT10T, GGMT20P, GGMT20T, GGVTO6P, GGVTO6T, GGVT10P, GGVT10T, GGVT20P, GGVT20T, GMT06D, GMT06P, GMT20D, GMT20P, GVT06D, GVT06P, GVT20D, HME061P...(Other models you can see in the webshop)		



1

<b>GEV No.</b>	692837	<b>Ref. No.</b>	11401340 LA11401340 LAR11401340
<b>description</b>	protective plate upper for glass plate combi-steamer H 8mm W 8mm		
<b>For models:</b>	ACE10M, ACG10M, AME07D, AME07P, AME10D, APE06, APE07, APG08M, APG10M, AVE07D, AVE07P, AVE10D, AVE10P, AVG10D, AVG20D, BPE064M, BPE064P, BPE074M, BPE074P, BPE084M, BPE084P, BPE104M, BPE104P, BPG064M, BPG064P, BPG074M, BPG074P, BPG084M, BPG084P, BPG104M, BPG104P, CE071M, CE100M, CE200M, CG071M, CG100M, CG200M, EMT06D, EMT10D, EMT20P, EPE056T, EPE086T, EPEV05T, EPEV08T, EPG056T, EPG086T, EPGV05T, EPGV08T, EVT06D, EVT06P...(Other models you can see in the webshop)		



accessories



1

<b>GEV No.</b>	699243	<b>Ref. No.</b>	69010200 LA69010200 LAR69010200
<b>description</b>	cover for handle W 23mm L 95mm		
<b>For models:</b>	A05PES, A05PES+UM, A05RES, A05RES+UM, A08PES, A08PES+UM, A08RES, A08RES+UM, A10PES, A10PES+UM, A10RES, A10RES+UM		





1

<b>GEV No.</b>	692834	<b>Ref. No.</b>	10207680 LA10207680 LAR10207680
<b>description</b>	fixing plate for door W 30mm L 50mm		
<b>For models:</b>	ABE156X, ABG156S, CEC40M, CES24M, CES40M, CGC24M, CGC40M, CGS24M, CGS40M, EMT21P, EPE156T, EPEV15T, EPG156T, EPGV15T, FME201SX, GEMT21P, GEMT21T, GEMT40P, GEMT40T, GEVT21P, GEVT21T, GEVT40P, GEVT40T, GGMT21P, GGMT21T, GGMT40P, GGMT40T, GGVT21P, GGVT21T, GGVT40P, GGVT40T, GSE201N, HME201P, HME201S, HME201T, HME201X, HME202P, HME202S, HME202T, HME202X, HMG201P, HMG201T, HMG201X, HMG202P, HMG202T, HMG202X, HVE201P, HVE201S, HVE201T, HVE201X...(Other models you can see in the webshop)		

vibration pumps



1

<b>GEV No.</b>	500568	<b>Ref. No.</b>	65110600 LAR65110600	
<b>description</b>	vibration pump 230V 32W 50Hz inlet $\phi$ 7 outlet $\phi$ 1/8" IT CEME type E512/A32			
<b>For models:</b>	ABE084S, ABE104S, ABE156X, ABG084X, ABG104X, ABG156S, AREN064, AREN084, AREN154, ARES064, ARES084, ARES154, ARGN064, ARGN084, ARGN154, ARGS064, ARGS084, ARGS154, CBEN061, CBES061, CEV026S, CEV026X, CEV061S, CEV061X, CEV101S, CEV101X, CKES10, CME061S, CME061X, COEN026, COEN061, COEN101, COES026, COES061, COES101, CVE024S, CVE024X, CVE061S, CVE061X, CVEN061, CVES061, CVG061S, CVG061X, CVGN061, CVGS061, EMT20P, EMT21P, EPE056T, EPE086T, EPE156T...(Other models you can see in the webshop)			
<b>spare parts for</b>	500568			
	<b>GEV No.</b>	390698	<b>Ref. No.</b>	—
	thermal fuse switch-off temp. 110°C suitable for ULKA pump			
	<b>GEV No.</b>	520153	<b>Ref. No.</b>	—
	bracket rubber dimensions 53x34x28mm			



1

<b>GEV No.</b>	501567	<b>Ref. No.</b>	65110620 LAR65110620
<b>description</b>	vibration pump type HF 230V 22W 50Hz inlet $\phi$ 6 outlet $\phi$ 6 ULKA plastic L 97mm connection male faston 4.8mm		
<b>For models:</b>	CBEN061, CBES061, CME061S, CME061X, GEMT07S, GEMT07X, GEMT10S, GEMT10X, GEMT20S, GEMT20X, GEMT21S, GEMT21X, GEMT40S, GEMT40X, GGMT07S, GGMT07X, GGMT10S, GGMT10X, GGMT20S, GGMT20X, GGMT21S, GGMT21X, GGMT40S, GGMT40X, HME101S, HME102S, HME201S, HME202S, KME061S, KME061X, KME072S, KME072X, KME081S, KME081X, KME101S, KME101X, KME102X, KME201S, KME201X, KME202S, KME202X, KMEA20S, KMEA20X, KMG072S, KMG072X, KMG081S, KMG081X, KMG101S, KMG101X, KMG102S...(Other models you can see in the webshop)		

heat exchangers



1

<b>GEV No.</b>	520509	<b>Ref. No.</b>	58004170 LA58004170 LAR58004170
<b>description</b>	reducing washer gas burner brass ID $\phi$ 3mm ED $\phi$ 16mm thickness 2.2mm code 3		
<b>For models:</b>	ABG064M, ABG074M, ARGN064, ARGS064, AVG05P, BPG044M, BPG044P, BPG054M, BPG054P, BPG064M, BPG064P, BPG074M, BPG074P, CG051M, CVG061S, CVG061X, EPG056T, EPGV05T, GGMT06P, GGMT06T, GGMT07S, GGMT07X, GGVT06P, GGVT06T, GGVT07S, GGVT07X, HMG061P, HMG061T, HMG061X, HVG061P, HVG061T, HVG061X, KMG081S, KMG081X, KVG061X, KVG081S, KVG081X, LBG0571, LBGT071, LVGS071, LVGT071, MACG05M, MCG051M, MCG071M, MMG071P, MVG051P, MVG071P, NAGB071, NAGB071R, NAGV071...(Other models you can see in the webshop)		

miscellaneous



1

<b>GEV No.</b>	696428	<b>Ref. No.</b>	11201970 LA11201970 LAR11201970
<b>description</b>	extension U-shape for injection pipe D1 $\phi$ 8mm D2 $\phi$ 10mm L 212mm WS 12 stainless steel		
<b>For models:</b>	ABE084S, ABE104S, ABE156X, ACE10M, AME10D, AVE10D, AVE10P, BPE084M, BPE084P, BPE104M, BPE104P, CE100M, CE200M, EMT10D, EMT20P, EMT21P, EPE086T, EPE156T, EPEV08T, EPEV15T, EPGV08T, EPGV15T, EVEA20S, EVT10P, EVT20D, GEMT10P, GEMT10T, GEMT20P, GEMT20T, GEMT21P, GEMT21T, GEVT10P, GEVT10T, GEVT20P, GEVT20T, GEVT20X, GEVT21P, GEVT21T, GGMT10P, GGMT10T, GGVT10P, GGVT10T, GSE201N, HME101P, HME101S, HME101T, HME101X, HME102P, HME102S, HME102T...(Other models you can see in the webshop)		

1

<b>GEV No.</b>	696394	<b>Ref. No.</b>	10206470 LAR10206470
<b>description</b>	extension U-shape for injection pipe D1 ø 8mm D2 ø 12mm L 113mm W 72mm		
<b>For models:</b>	CE106M, CG106M, EC106M, EM006H, EM006M+SC, EM106H, EM106M, EM106M+SC, EM106P, EV006M, EV006P, EV106H, EV106M, EV106M+SC, EV106P, GC106M, GM106H, GM106M, GM106M+SC, GM106P, GV006H, GV006M, GV106H, GV106M, GV106M+SC, GV106P, ME106D, ME106H, ME106M, ME106P, ME106X, MG106D, MG106H, MG106M, MG106P, MG106X, VE106D, VE106H, VE106M, VE106P, VE106X, VG106D, VG106H, VG106M, VG106P, VG106X		



1

<b>GEV No.</b>	691290	<b>Ref. No.</b>	10100140 LAR10100140
<b>description</b>	extractor stubs complete		
<b>For models:</b>	ABE084S, ABE104S, ABE156X, ABG084X, ABG104X, ABG156S, AME07P, AVE07P, AVE10P, BPE064P, BPE074P, BPE084P, BPE104P, BPG064P, BPG074P, BPG084P, BPG104P, EPE056T, EPE086T, EPEV05T, EPEV08T, EPG056T, EPG086T, EPGV05T, EPGV08T, EVEA20S, EVT06P, EVT10P, FEI102P, FME101AX, FME201SX, FME61A, FME61S, FMG201A, FMG201S, GEMT06P, GEMT06T, GEMT10P, GEMT10T, GEMT20P, GEMT20T, GEMT21P, GEMT21S, GEMT21T, GEMT21X, GEMT40S, GEMT40X, GEVT06P, GEVT06S, GEVT06T...(Other models you can see in the webshop)		



1

<b>GEV No.</b>	691282	<b>Ref. No.</b>	58005350 LA58005350 LAR58005350
<b>description</b>	gasket for door handle D1 ø 30mm D2 ø 18mm mounting pos. upper H 1.4mm		
<b>For models:</b>	ACE04M, ACE05M, ACE10M, ACG10M, AME07D, AME07P, AME10D, APE06, APE07, APG08M, APG10M, AVE07D, AVE07P, AVE10D, AVE10P, AVG05P, AVG10D, AVG20D, BPE044M, BPE044P, BPE054M, BPE054P, BPE064M, BPE064P, BPE074M, BPE074P, BPE084M, BPE084P, BPE104M, BPE104P, BPG044M, BPG044P, BPG054M, BPG054P, BPG064M, BPG064P, BPG074M, BPG074P, BPG084M, BPG084P, BPG104M, BPG104P, CE041M, CE051M, CE071M, CE100M, CE106M, CE110M, CE200M, CE210M...(Other models you can see in the webshop)		



1

<b>GEV No.</b>	691291	<b>Ref. No.</b>	70060020 LA70060020 LAR70060020
<b>description</b>	gasket for extractor stubs D1 ø 30mm D2 ø 35mm W 9mm		
<b>For models:</b>	ABE084S, ABE104S, ABE156X, ABG156S, AME07P, AVE07P, AVE10P, BPE064P, BPE074P, BPE084P, BPE104P, BPG064P, BPG074P, BPG084P, BPG104P, CKES10, EPE056T, EPE086T, EPEV05T, EPEV08T, EPG056T, EPG086T, EPGV05T, EPGV08T, EVEA20S, EVT06P, EVT10P, FEI102P, FME101AX, FME201SX, FME61A, FME61S, FMG201A, FMG201S, GEMT06P, GEMT06T, GEMT07S, GEMT07X, GEMT10P, GEMT10S, GEMT10T, GEMT10X, GEMT20P, GEMT20S, GEMT20T, GEMT20X, GEMT21P, GEMT21S, GEMT21T, GEMT21X...(Other models you can see in the webshop)		



1

<b>GEV No.</b>	690762	<b>Ref. No.</b>	69180180 LAR69180180
<b>description</b>	gutter for inner door L 790mm plastic W 34mm with screws		
<b>For models:</b>	EPE056T, EPE086T, EPEV05T, EPEV08T, EPG056T, EPG086T, EPGV05T, EPGV08T, GEMT20P, GEMT20T, GEVT20P, GEVT20T, GEVT20X, GG-MT20P, GG-MT20T, GG-VT20P, GG-VT20T, HME101P, HME101S, HME101T, HME101X, HME102P, HME102S, HME102T, HME102X, HMG101P, HMG101T, HMG101X, HMG102P, HMG102T, HMG102X, HVE101P, HVE101S, HVE101T, HVE101X, HVE102P, HVE102S, HVE102T, HVE102X, HVG101P, HVG101T, HVG101X, HVG102P, HVG102T, HVG102X, KME072S, KME072X, KME102X, KMG072S, KMG072X...(Other models you can see in the webshop)		



1

<b>GEV No.</b>	690099	<b>Ref. No.</b>	50005090 58002150 LA58002150 LAR50005090 LAR58002150
<b>description</b>	hinge pin mounting pos. upper for door		
<b>For models:</b>	ABE044M, ABE054M, ABE084S, ABE104S, ABE156X, ABG064M, ABG074M, ABG084X, ABG104X, ABG156S, ACE10M, ACG10M, AME07D, AME07P, AME10D, APE06, APE07, APG08M, APG10M, AREN154, ARES154, ARGN154, ARGS154, AVE07D, AVE07P, AVE10D, AVE10P, AVG10D, AVG20D, BPE064M, BPE064P, BPE074M, BPE074P, BPE084M, BPE084P, BPE104M, BPE104P, BPG064M, BPG064P, BPG074M, BPG074P, BPG084M, BPG084P, BPG104M, BPG104P, CE071M, CE100M, CE106M, CE110M, CE200M...(Other models you can see in the webshop)		





			
1			
<b>GEV No.</b>	696547	<b>Ref. No.</b>	11202270 LA11202270 LAR11202270
<b>description</b>	injection pipe angled for combi-steamer D1 ø 10mm D2 ø 8mm L 170mm		
<b>For models:</b>	BPE064M, BPE064P, BPE074M, BPE074P, BPE084M, BPE084P, BPE104M, BPE104P, BPG064M, BPG064P, BPG074M, BPG074P, BPG084M, BPG084P, BPG104M, BPG104P, EPEV05T, EPEV08T, EPEV15T, EPGV05T, EPGV08T, EPGV15T, EVEA20S, GEMT20P, GEMT20T, GEMT40P, GEMT40T, GEVT20P, GEVT20T, GEVT20X, GEVT40P, GEVT40T, GGMT20P, GGMT20T, GGMT21P, GGMT21T, GGMT40P, GGMT40T, GGV20P, GGV20T, GGV21P, GGV21T, GGV40P, GGV40T, GS-E201N, HME061P, HME061T, HME061X, HME101P, HME101S...(Other models you can see in the webshop)		

			
1			
<b>GEV No.</b>	506229	<b>Ref. No.</b>	11200380 LA11200380 LAR11200380
<b>description</b>	injection pipe for combi-steamer L 205mm ø 10mm		
<b>For models:</b>	ACE10M, ACG10M, AME07D, AME07P, AME10D, APE06, APE07, APG08M, APG10M, AVE07D, AVE07P, AVE10D, AVE10P, AVG10D, AVG20D, CE071M, CE100M, CE200M, CG071M, CG100M, CG200M, EMT06D, EMT10D, EMT20P, EMT21P, EVT06D, EVT06P, EVT10P, EVT20D, GEMT06P, GEMT06T, GEMT10P, GEMT10T, GEVT06P, GEVT06S, GEVT06T, GEVT10P, GEVT10T, GGMT06P, GGMT06T, GGMT10P, GGMT10T, GGV06P, GGV06T, GGV10P, GGV10T, GMT06D, GMT06P, GMT20D, GMT20P...(Other models you can see in the webshop)		

			
1			
<b>GEV No.</b>	691289	<b>Ref. No.</b>	58004830 LAR58004830
<b>description</b>	nut thread M18x1 H 5mm WS 22 brass Qty 1 pcs for door handle		
<b>For models:</b>	ACE04M, ACE05M, ACE10M, ACG10M, AME07D, AME07P, AME10D, APE06, APE07, APG08M, APG10M, AVE07D, AVE07P, AVE10D, AVE10P, AVG05P, AVG10D, AVG20D, BPE044M, BPE044P, BPE054M, BPE054P, BPE064M, BPE064P, BPE074M, BPE074P, BPE084M, BPE084P, BPE104M, BPE104P, BPG044M, BPG044P, BPG054M, BPG054P, BPG064M, BPG064P, BPG074M, BPG074P, BPG084M, BPG084P, BPG104M, BPG104P, CE041M, CE051M, CE071M, CE100M, CE106M, CE110M, CE200M, CE210M...(Other models you can see in the webshop)		

			
1			
<b>GEV No.</b>	691296	<b>Ref. No.</b>	61400052 LA61400052 LAR61400052
<b>description</b>	plain washer ID ø 10.5mm ED ø 21mm thickness 2mm SS Qty 1 pcs for fan wheel		
<b>For models:</b>	ABG064M, ABG074M, AME07D, AME07P, APE06, APE07, AVE07D, AVE07P, BPE064M, BPE064P, BPE074M, BPE074P, BPG064M, BPG064P, BPG074M, BPG074P, CE071M, CE106M, CG071M, CG105M, CG106M, CG106M, CVE105H, CVE105M, CVG105H, CVG105M, EC106M, EM006H, EM006M+SC, EM106H, EM106M, EM106M+SC, EM106P, EMT06D, EV006M, EV006P, EV106H, EV106M, EV106M+SC, EV106P, EVT06D, EVT06P, FE051M, FE051X, FE105M, FE105X, FG051M, FG051X, FG105M, FG105X, FME61A...(Other models you can see in the webshop)		

			
1			
<b>GEV No.</b>	691292	<b>Ref. No.</b>	10401710 LAR10401710
<b>description</b>	plain washer ID ø 12mm ED ø 17.5mm thickness 1mm SS Qty 1 pcs		
<b>For models:</b>	ACE10M, ACG10M, AME07D, AME07P, AME10D, APE06, APE07, APG08M, APG10M, AVE07D, AVE07P, AVE10D, AVE10P, AVG10D, AVG20D, BPE064M, BPE064P, BPE074M, BPE074P, BPE084M, BPE084P, BPE104M, BPE104P, BPG064M, BPG064P, BPG074M, BPG074P, BPG084M, BPG084P, BPG104M, BPG104P, CE071M, CE100M, CE106M, CE110M, CE200M, CE210M, CG071M, CG100M, CG106M, CG110M, CG200M, CG210M, EMT06D, EMT10D, EMT20P, EPE056T, EPE086T, EPEV05T, EPEV08T...(Other models you can see in the webshop)		

			
1			
<b>GEV No.</b>	691283	<b>Ref. No.</b>	58003240 LAR58003240
<b>description</b>	pressure bolt for door handle D1 ø 8mm D2 ø 11mm L 73mm thread M6 bolt 16mm bolt ø 5mm		
<b>For models:</b>	ACE04M, ACE05M, ACE10M, ACG10M, AME07D, AME07P, AME10D, APE06, APE07, APG08M, APG10M, AVE07D, AVE07P, AVE10D, AVE10P, AVG05P, AVG10D, AVG20D, BPE044M, BPE044P, BPE054M, BPE054P, BPE064M, BPE064P, BPE074M, BPE074P, BPE084M, BPE084P, BPE104M, BPE104P, BPG044M, BPG044P, BPG054M, BPG054P, BPG064M, BPG064P, BPG074M, BPG074P, BPG084M, BPG084P, BPG104M, BPG104P, CE041M, CE051M, CE071M, CE100M, CE106M, CE110M, CE200M, CE210M...(Other models you can see in the webshop)		

mechanical components, equipment accessories



1

<b>GEV No.</b>	691297	<b>Ref. No.</b>	62030118 LA62030118 LAR62030118
<b>description</b>	reducer thread 1/4 / 1/8		
<b>For models:</b>	ABE084S, ABE104S, ABG084X, ABG104X, ABG156S, AVE07D, AVE07P, AVE10D, AVE10P, AVG05P, AVG10D, AVG20D, BPE044P, BPE054P, BPE064M, BPE064P, BPE074M, BPE074P, BPE084M, BPE084P, BPE104M, BPE104P, BPG044P, BPG054P, BPG064M, BPG064P, BPG074M, BPG074P, BPG084M, BPG084P, BPG104M, BPG104P, CEV061S, CEV061X, CVE024S, CVE061S, EPE056T, EPE086T, EPE156T, EPEV05T, EPEV08T, EPEV15T, EPG056T, EPG086T, EPG156T, EPGV05T, EPGV08T, EPGV15T, EVEA20S, EVT06D...(Other models you can see in the webshop)		
<b>accessories for</b>	691297		
	<b>GEV No.</b>	529544	<b>Ref. No.</b> —
O-ring EPDM thickness 2.62mm ID ø 7.59mm Qty 1 pcs			



1

<b>GEV No.</b>	694319	<b>Ref. No.</b>	58003390 LA58003390 LAR58003390
<b>description</b>	screw connection for pressure switch L 50mm WS 30 brass thread 1/4"		
<b>For models:</b>	CG105M, CVE004H, CVE004M, CVE104H, CVE104M, CVE105H, CVE105M, CVG105H, CVG105M, EV006P, EV010H, EV010P, EV106H, EV106P, EV110H, EV110P, EV210H, EV210P, FEI102P, FME101AX, FME2015X, GV006H, GV010H, GV020H, GV106H, GV106P, GV110H, GV110P, GV210H, GV210P, MG202D, MG202H, MG202M, MG202P, MG202T, MGMT40D, MGMT40P, MGMT40D, MGMT40P, PE005K, PE008K, PE015K, PE088K, PE105D, PE105K, PE105T, PE108D, PE108K, PE108T, PE115D...(Other models you can see in the webshop)		



1

<b>GEV No.</b>	691280	<b>Ref. No.</b>	58005340 LA58005340 LAR58005340
<b>description</b>	sealing disc for door handle mounting pos. lower ED ø 25mm ID ø 5.5mm H 5mm		
<b>For models:</b>	ACE04M, ACE05M, ACE10M, ACG10M, AME07D, AME07P, AME10D, APE06, APE07, APG08M, APG10M, AVE07D, AVE07P, AVE10D, AVE10P, AVG05P, AVG10D, AVG20D, BPE044M, BPE044P, BPE054M, BPE054P, BPE064M, BPE064P, BPE074M, BPE074P, BPE084M, BPE084P, BPE104M, BPE104P, BPG044M, BPG044P, BPG054M, BPG054P, BPG064M, BPG064P, BPG074M, BPG074P, BPG084M, BPG084P, BPG104M, BPG104P, CE041M, CE051M, CE071M, CE100M, CE106M, CE110M, CE200M, CE210M...(Other models you can see in the webshop)		



1

<b>GEV No.</b>	691281	<b>Ref. No.</b>	58004270 LAR58004270
<b>description</b>	spacer piece for door handle L 34mm ID ø 6mm ED ø 8mm		
<b>For models:</b>	ACE04M, ACE05M, ACE10M, ACG10M, AME07D, AME07P, AME10D, APE06, APE07, APG08M, APG10M, AVE07D, AVE07P, AVE10D, AVE10P, AVG05P, AVG10D, AVG20D, BPE044M, BPE044P, BPE054M, BPE054P, BPE064M, BPE064P, BPE074M, BPE074P, BPE084M, BPE084P, BPE104M, BPE104P, BPG044M, BPG044P, BPG054M, BPG054P, BPG064M, BPG064P, BPG074M, BPG074P, BPG084M, BPG084P, BPG104M, BPG104P, CE041M, CE051M, CE071M, CE100M, CE106M, CE110M, CE200M, CE210M...(Other models you can see in the webshop)		



1

<b>GEV No.</b>	692300	<b>Ref. No.</b>	70050100 70050180 LAR70050100 LAR70050180
<b>description</b>	stopper with screw connection for glass plate D1 ø 15mm L 8mm thread M4		
<b>For models:</b>	ABE044M, ABE054M, ABE084S, ABE104S, ABE156X, ABG064M, ABG074M, ABG084X, ABG104X, ABG156S, ACE10M, ACG10M, AME07D, AME07P, AME10D, APE06, APE07, APG08M, APG10M, AREN064, AREN084, AREN154, ARES064, ARES084, ARES154, ARGNO64, ARGNO84, ARGN154, ARGS064, ARGS084, ARGS154, AVE07D, AVE07P, AVE10D, AVE10P, AVG10D, AVG20D, BPE064M, BPE064P, BPE074M, BPE074P, BPE084M, BPE084P, BPE104M, BPE104P, BPG064M, BPG064P, BPG074M, BPG074P, BPG084M...(Other models you can see in the webshop)		

## for dishwashers

## backflow preventers

## non-return valves



1

<b>GEV No.</b>	520886	<b>Ref. No.</b>	65110640 LAR65110640 LARR65110640
<b>description</b>	non-return valve plastic total length 67mm		
<b>For models:</b>	ABE084S, ABE104S, ABE156X, ABG156S, EMT20P, EMT21P, EPE056T, EPE086T, EPE156T, EPEV05T, EPEV08T, EPEV15T, EPG056T, EPG086T, EPG156T, EPGV05T, EPGV08T, EPGV15T, EVEA20S, GEMT06P, GEMT06T, GEMT10P, GEMT10T, GEMT20P, GEMT20T, GEMT21P, GEMT21T, GEMT40P, GEMT40T, GEVT06P, GEVT06S, GEVT06T, GEVT10P, GEVT10T, GEVT20P, GEVT20T, GEVT20X, GEVT21P, GEVT21T, GEVT40P, GEVT40T, GGMT06P, GGMT06T, GGMT10P, GGMT10T, GGMT20P, GGMT20T, GGMT21P, GGMT21T, GGMT40P...(Other models you can see in the webshop)		







## knobs

### producer-specific knobs

#### LAINOX

			
1			
<b>GEV No.</b>	111772	<b>Ref. No.</b>	69030260 69030280 LA69030260 LA69030280 LAR69030260 LAR69030280
<b>description</b>	knob ø 42mm shaft ø 6x4.6mm shaft flat universal		
<b>For models:</b>	ABE084S, ABE104S, ABG156S, AME07D, AME07P, AME10D, ARES064, ARES084, ARES154, ARGS064, ARGS084, ARGS154, AVE07D, AVE07P, AVE10D, AVE10P, AVG05P, AVG10D, AVG20D, BPE044P, BPE054P, BPE064P, BPE074P, BPE084P, BPE104P, BPG044P, BPG054P, BPG064P, BPG074P, BPG084P, BPG104P, CBES061, CEV026S, CEV026X, CEV061S, CEV061X, CEV101S, CEV101X, CKES10, CME061S, CME061X, COES026, COES061, COES101, CVE024S, CVE024X, CVE061S, CVE061X, CVES061, CVG061S...(Other models you can see in the webshop)		

			
1			
<b>GEV No.</b>	111791	<b>Ref. No.</b>	69030270 LA69030270 LAR69030270
<b>description</b>	knob ø 61mm shaft ø 6x4.6mm black		
<b>For models:</b>	GEMT20P, GEMT20T, GEMT40P, GEMT40T, GEVT20P, GEVT20T, GEVT40P, GEVT40T, GGMT06P, GGMT06T, GGMT10P, GGMT10T, GGMT20P, GGMT20T, GGMT21P, GGMT21T, GGMT40P, GGMT40T, GGVT06P, GGVT06T, GGVT10P, GGVT10T, GGVT20P, GGVT20T, GGVT21P, GGVT21T, GGVT40P, GGVT40T, HME061P, HME061T, HME061X, HME101P, HME101T, HME101X, HME102P, HME102T, HME102X, HME201P, HME201T, HME201X, HME202P, HME202T, HME202X, HMG061P, HMG061T, HMG061X, HMG101P, HMG101T, HMG101X, HMG102P...(Other models you can see in the webshop)		

			
1			
<b>GEV No.</b>	111771	<b>Ref. No.</b>	50103120 50103130 69030050 69030060 69030080 69030170 69030250 69030290 LA69030170 LAR50103130 LAR69030060 LAR69030080 LAR69030170 LAR69030250 LAR69030290
<b>description</b>	knob switch zero mark ø 42mm shaft ø 6x4.6mm shaft flat upper black		
<b>For models:</b>	ABE044M, ABE054M, ABE156X, ABG064M, ABG074M, ABG084X, ABG104X, ACE04M, ACE05M, ACE10M, ACG10M, APE06, APE07, APG08M, APG10M, BPE044M, BPE054M, BPE064M, BPE074M, BPE084M, BPE104M, BPG044M, BPG054M, BPG064M, BPG074M, BPG084M, BPG104M, CE041M, CE051M, CE071M, CE100M, CE200M, CG051M, CG071M, CG100M, CG200M, ECO20M, EC106M, EC110M, EC210M, EM006H, EM006M+SC, EM010H, EM010M+SC, EM020M, EM106H, EM106M, EM106M+SC, EM106P, EM110H...(Other models you can see in the webshop)		

## locks

### handle latches

#### producer-specific

#### LAINOX

#### group 1

			
1			
<b>GEV No.</b>	690337	<b>Ref. No.</b>	69010630 LAR69010630
<b>description</b>	cover L 39.5mm ø 55.5mm		
<b>For models:</b>	ABE044M, ABE054M, ABE084S, ABE104S, ABG064M, ABG074M, ABG084X, ABG104X, AREN064, AREN084, ARES064, ARES084, ARGN064, ARGN084, ARGS064, ARGS084, CBEN061, CBES061, CKES10, CME061S, CME061X, CVE024S, CVE024X, CVE061S, CVE061X, CVEN061, CVES061, CVG061S, CVG061X, CVGN061, CVGS061, EMT06D, EMT10D, EMT20P, EPE056T, EPE086T, EPEV05T, EPEV08T, EPG056T, EPG086T, EPGV05T, EPGV08T, EVEA20S, EVT06D, EVT06P, EVT10P, EVT20D, GEMT06P, GEMT06T, GEMT07S...(Other models you can see in the webshop)		

 <p>1</p>			
<b>GEV No.</b>	694067	<b>Ref. No.</b>	69010260 LA69010260 LAR69010260
<b>description</b>	door catch with spigot 1-stage L 26mm total length 51mm thread M8		
<b>For models:</b>	ABE044M, ABE054M, ABE084S, ABE104S, ABG064M, ABG074M, ABG084X, ABG104X, AREN064, AREN084, ARES064, ARES084, ARGN064, ARGN084, ARGS064, ARGS084, CBEN061, CBES061, CEV026S, CEV026X, CEV061S, CEV061X, CEV101S, CEV101X, CKES10, CME061S, CME061X, COEN026, COEN061, COEN101, COES026, COES061, COES101, CVE024S, CVE024X, CVE061S, CVE061X, CVEN061, CVES061, CVG061S, CVG061X, CVGN061, CVGS061, EMT06D, EMT10D, EMT20P, EPE056T, EPE086T, EPEV05T, EPEV08T...(Other models you can see in the webshop)		







 <p>2</p>			
<b>GEV No.</b>	690339	<b>Ref. No.</b>	69010270 LAR69010270
<b>description</b>	door catch with spigot 2-stage L 30mm H 17mm H1 18mm total length 55mm thread M8 thread L 20mm stainless steel		
<b>For models:</b>	AREN064, AREN084, ARES064, ARES084, ARGN064, ARGN084, ARGS064, ARGS084, CBEN061, CBES061, CEV026S, CEV026X, CEV061S, CEV061X, CEV101S, CEV101X, CME061S, CME061X, COEN026, COEN061, COEN101, COES026, COES061, COES101, CVE024S, CVE024X, CVE061S, CVE061X, CVEN061, CVES061, CVG061S, CVG061X, CVGN061, CVGS061, EMT06D, EMT10D, EMT20P, EPE056T, EPE086T, EPEV05T, EPEV08T, EPG056T, EPG086T, EPGV05T, EPGV08T, EVT06D, EVT06P, EVT10P, EVT20D, GEMT06P...(Other models you can see in the webshop)		

 <p>1</p>			
<b>GEV No.</b>	694284	<b>Ref. No.</b>	11100300 11100330 LAR11100300 LAR11100330
<b>description</b>	door catch kit		
<b>For models:</b>	EMT06D, EMT10D, EMT20P, EPE056T, EPE086T, EPEV05T, EPEV08T, EPG056T, EPG086T, EPGV05T, EPGV08T, EVT06D, EVT06P, EVT10P, EVT20D, GEMT06P, GEMT06T, GEMT10P, GEMT10T, GEMT20P, GEMT20T, GEVT06P, GEVT06S, GEVT06T, GEVT10P, GEVT10T, GEVT20P, GEVT20T, GEVT20X, GGMT06P, GGMT06T, GGMT10P, GGMT10T, GGMT20P, GGMT20T, GGVT06P, GGVT06T, GGVT10P, GGVT10T, GGVT20P, GGVT20T, GMT06D, GMT06P, GMT20D, GMT20P, GVT06D, GVT06P, GVT20D, HME061P, HME061T...(Other models you can see in the webshop)		

 <p>1</p>			
<b>GEV No.</b>	692709	<b>Ref. No.</b>	69010210 LA69010210 LAR69010210
<b>description</b>	door handle complete 6303 L 170mm W 53mm H 68mm handle ø 37mm spring length 45mm mounting distance 39mm mounting thread M3		
<b>For models:</b>	CVE024S, CVE024X, EVEA20S, SCE051M, SCE071M, SCE101M, SME071S, SME101S, SMG101S, SVE042S, SVE051S, SVE071P, SVE071S, SVE101S, SVEA20S, SVG101S		

 <p>1</p>			
<b>GEV No.</b>	692806	<b>Ref. No.</b>	69010290 69010460 LA69010230 LAR69010230 LAR69010290 LAR69010460
<b>description</b>	door handle for combi-steamer L 175mm W 100mm H 53mm spring length 42mm M4 black plastic round		
<b>For models:</b>	CEV026S, CEV026X, CEV061S, CEV061X, CEV101S, CEV101X, REC051M, REC071M, REC101M, REP044M, REP044S, REP054M, REP054S, REP064M, REP064S, REP074M, REP074S, REP084M, REP084S, REP104M, REP104S, REV051M, REV051S, REV071M, REV071S, REV101M, REV101S, RGC051M, RGC071M, RGC101M, RGP044M, RGP044S, RGP054M, RGP054S, RGP064M, RGP064S, RGP074M, RGP074S, RGP084M, RGP084S, RGP104M, RGP104S, RGV051M, RGV051S, RGV071M, RGV071S, RGV101M, RGV101S		



 <p>1</p>			
<b>GEV No.</b>	690336	<b>Ref. No.</b>	69010250 69010440 LA69010440 LAR69010250 LAR69010430 LAR69010440
<b>description</b>	door handle L 195mm H 60mm mounting distance 40mm spring length 46mm ø 60mm black plastic round		
<b>For models:</b>	CKES10, CME061S, CME061X, CVE061S, CVE061X, CVG061S, CVG061X, EMT06D, EMT10D, EMT20P, EPE056T, EPE086T, EPEV05T, EPEV08T, EPG056T, EPG086T, EPGV05T, EPGV08T, EVT06D, EVT06P, EVT10P, EVT20D, GEMT06P, GEMT06T, GEMT07S, GEMT07X, GEMT10P, GEMT10S, GEMT10T, GEMT10X, GEMT20P, GEMT20S, GEMT20T, GEMT20X, GEVT06P, GEVT06S, GEVT06T, GEVT07S, GEVT07X, GEVT10P, GEVT10S, GEVT10T, GEVT10X, GEVT20P, GEVT20S, GEVT20T, GEVT20X, GGMT06P, GGMT06T, GGMT07S...(Other models you can see in the webshop)		
<b>spare parts for</b>	690336		
	<b>GEV No.</b>	514390	<b>Ref. No.</b>
			61620132 LA61620132 LAR61620132 R61620132
	spring for door handle ø 6mm L 54mm W 27.5mm		
	<b>GEV No.</b>	691666	<b>Ref. No.</b>
			—
	catch clamp length 46mm BL 31mm for off-set 59-69mm		
<b>accessories for</b>	690336		
	<b>GEV No.</b>	690337	<b>Ref. No.</b>
			69010630 LAR69010630 R69010630
	cover L 39.5mm ø 55.5mm		
	<b>GEV No.</b>	690339	<b>Ref. No.</b>
			69010270 LAR69010270 R69010270
	door catch with spigot 2-stage L 30mm H 17mm H1 18mm total length 55mm thread M8 thread L 20mm stainless steel		
	<b>GEV No.</b>	694067	<b>Ref. No.</b>
			69010260 LA69010260 LAR69010260 R69010260
	door catch with spigot 1-stage L 26mm total length 51mm thread M8		

 <p>1</p>			
<b>GEV No.</b>	514390	<b>Ref. No.</b>	61620132 LA61620132 LAR61620132
<b>description</b>	spring for door handle ø 6mm L 54mm W 27.5mm		
<b>For models:</b>	ABE044M, ABE054M, ABE084S, ABE104S, ABG064M, ABG074M, ABG084X, ABG104X, AREN064, AREN084, ARES064, ARES084, ARGN064, ARGN084, ARG5064, ARG5084, CBEN061, CBES061, CME061S, CME061X, CVE024S, CVE024X, CVE061S, CVE061X, CVEN061, CVES061, CVG061S, CVG061X, CVGN061, CVGS061, EMT06D, EMT10D, EMT20P, EPE056T, EPE086T, EPEV05T, EPEV08T, EPG056T, EPG086T, EPGV05T, EPGV08T, EVEA20S, EVT06D, EVT06P, EVT10P, EVT20D, GEMT06P, GEMT06T, GEMT07S, GEMT07X...(Other models you can see in the webshop)		

<p>group 2</p>  <p>1</p>			
<b>GEV No.</b>	690094	<b>Ref. No.</b>	50004040 58002160 LA58002160 LAR50004040 LAR58002160
<b>description</b>	bolt ø 4mm L 36mm		
<b>For models:</b>	ACE04M, ACE05M, ACE10M, ACG10M, AME07D, AME07P, AME10D, APE06, APE07, APG08M, APG10M, AVE07D, AVE07P, AVE10D, AVE10P, AVG05P, AVG10D, AVG20D, BPE044M, BPE044P, BPE054M, BPE054P, BPE064M, BPE064P, BPE074M, BPE074P, BPE084M, BPE084P, BPE104M, BPE104P, BPG044M, BPG044P, BPG054M, BPG054P, BPG064M, BPG064P, BPG074M, BPG074P, BPG084M, BPG084P, BPG104M, BPG104P, CE041M, CE051M, CE071M, CE100M, CE106M, CE110M, CE200M, CE210M...(Other models you can see in the webshop)		

 <p>1</p>			
<b>GEV No.</b>	690093	<b>Ref. No.</b>	50004090 58005050 LAR50004090 LAR58005050
<b>description</b>	catch hook L 27mm W 12mm H 19.6mm hole ø 4mm		
<b>For models:</b>	ACE04M, ACE05M, ACE10M, ACG10M, AME07D, AME07P, AME10D, APE06, APE07, APG08M, APG10M, AVE07D, AVE07P, AVE10D, AVE10P, AVG05P, AVG10D, AVG20D, BPE044M, BPE044P, BPE054M, BPE054P, BPE064M, BPE064P, BPE074M, BPE074P, BPE084M, BPE084P, BPE104M, BPE104P, BPG044M, BPG044P, BPG054M, BPG054P, BPG064M, BPG064P, BPG074M, BPG074P, BPG084M, BPG084P, BPG104M, BPG104P, CE041M, CE051M, CE071M, CE100M, CE106M, CE110M, CE200M, CE210M...(Other models you can see in the webshop)		

mechanical components, equipment accessories



<b>GEV No.</b>	690091	<b>Ref. No.</b>	50202710 61620041 LA61620041 LAR50202710 LAR61620041
<b>description</b>	compression spring ø 12mm L 49mm wire gauge ø 1mm		
<b>For models:</b>	ACE04M, ACE05M, ACE10M, ACG10M, AME07D, AME07P, AME10D, APE06, APE07, APG08M, APG10M, AVE07D, AVE07P, AVE10D, AVE10P, AVG05P, AVG10D, AVG20D, BPE044M, BPE044P, BPE054M, BPE054P, BPE064M, BPE064P, BPE074M, BPE074P, BPE084M, BPE084P, BPE104M, BPE104P, BPG044M, BPG044P, BPG054M, BPG054P, BPG064M, BPG064P, BPG074M, BPG074P, BPG084M, BPG084P, BPG104M, BPG104P, CE041M, CE051M, CE071M, CE100M, CE106M, CE110M, CE200M, CE210M...(Other models you can see in the webshop)		



<b>GEV No.</b>	692830	<b>Ref. No.</b>	10100100 LA10100100 LAR10100100
<b>description</b>	door catch for combi-steamer L 62mm mounting distance 46mm hole ø 6mm		
<b>For models:</b>	CG105M, CVE004H, CVE004M, CVE104H, CVE104M, CVE105H, CVE105M, CVG105H, CVG105M, ME004L, ME004S, ME104L, ME104S, VE004D, VE004H, VE004M, VE004S, VE004X, VE104D, VE104H, VE104M, VE104S, VE104X, VE105D, VE105H, VE105M, VE105X, VE155H, VE155M, VE155X, VG105D, VG105H, VG105M, VG105X		
<b>spare parts for</b>	692830		



<b>GEV No.</b>	690093	<b>Ref. No.</b>	50004090 58005050 LAR50004090 LAR58005050 R50004090 R58005050
<b>description</b>	catch hook L 27mm W 12mm H 19.6mm hole ø 4mm		



<b>GEV No.</b>	690094	<b>Ref. No.</b>	50004040 58002160 LA58002160 LAR50004040 LAR58002160 R50004040 R58002160
<b>description</b>	bolt ø 4mm L 36mm		



<b>GEV No.</b>	690095	<b>Ref. No.</b>	50001196 61620012 LA61620012 LAR50001196 LAR61620012 R50001196 R61620012
<b>description</b>	torsion spring ø 6mm L2 15mm wire gauge ø 0.9mm L1 2x6mm L3 15mm Qty 1 pcs for closing hub		



<b>GEV No.</b>	691274	<b>Ref. No.</b>	18200940 LA18200940 LAR18200940
<b>description</b>	door catch H 33mm L 40mm W 25mm mounting distance 12mm		
<b>For models:</b>	ACE04M, ACE05M, AVG05P, BPE044M, BPE044P, BPE054M, BPE054P, BPG044M, BPG044P, BPG054M, BPG054P, CE041M, CE051M, CG051M, MACE04M, MACE05M, MACG05M, MCE042M, MCE051M, MCG051M, MVE042P, MVE051P, MVG051P, PE044M, PE054M, VE042P, VE051P, VE055P, VG051P		



<b>GEV No.</b>	691275	<b>Ref. No.</b>	18202020 LA18202020 LAR18202020
<b>description</b>	door catch H 45mm W 37mm mounting distance 12mm		
<b>For models:</b>	ACE10M, ACG10M, AME07D, AME07P, AME10D, APE06, APE07, APG08M, APG10M, AVE07D, AVE07P, AVE10D, AVE10P, AVG10D, AVG20D, BPE064M, BPE064P, BPE074M, BPE074P, BPE084M, BPE084P, BPE104M, BPE104P, BPG064M, BPG064P, BPG074M, BPG074P, BPG084M, BPG084P, BPG104M, BPG104P, CE071M, CE100M, CE200M, CG071M, CG100M, CG200M, MACE07M, MACE10M, MACE20M, MACG07M, MACG10M, MACG20M, MCE071M, MCE101M, MCE102M, MCG071M, MCG101M, MCG102M, MME071P...(Other models you can see in the webshop)		



<b>GEV No.</b>	690092	<b>Ref. No.</b>	10100110 LAR10100110
<b>description</b>	door catch L 62mm W 35.5mm H 26.5mm mounting distance 19/46mm		
<b>For models:</b>	ACE04M, ACE05M, ACE10M, ACG10M, AME07D, AME07P, AME10D, APE06, APE07, APG08M, APG10M, AVE07D, AVE07P, AVE10D, AVE10P, AVG05P, AVG10D, AVG20D, BPE044M, BPE044P, BPE054M, BPE054P, BPE064M, BPE064P, BPE074M, BPE074P, BPE084M, BPE084P, BPE104M, BPE104P, BPG044M, BPG044P, BPG054M, BPG054P, BPG064M, BPG064P, BPG074M, BPG074P, BPG084M, BPG084P, BPG104M, BPG104P, CE041M, CE051M, CE071M, CE100M, CE106M, CE110M, CE200M, CE210M...(Other models you can see in the webshop)		
<b>spare parts for</b>	690092		



<b>GEV No.</b>	690093	<b>Ref. No.</b>	50004090 58005050 LAR50004090 LAR58005050 R50004090 R58005050
<b>description</b>	catch hook L 27mm W 12mm H 19.6mm hole ø 4mm		



<b>GEV No.</b>	690094	<b>Ref. No.</b>	50004040 58002160 LA58002160 LAR50004040 LAR58002160 R50004040 R58002160
<b>description</b>	bolt ø 4mm L 36mm		







<b>GEV No.</b>	690095	<b>Ref. No.</b>	50001196 61620012 LA61620012 LAR50001196 LAR61620012 R50001196 R61620012
<b>description</b>	torsion spring ø 6mm L2 15mm wire gauge ø 0.9mm L1 2x6mm L3 15mm Qty 1 pcs for closing hub		

<b>accessories for</b>	690092		
<b>GEV No.</b>	560370	<b>Ref. No.</b>	—
<b>description</b>	countersunk screw thread M5 L 16mm stainless steel DIN 965/ISO 7046 Qty 1 pcs intake Phillips head ø 9mm		



			
1			
<b>GEV No.</b>	691279	<b>Ref. No.</b>	09200230 LAR09200230
<b>description</b>	door handle		
<b>For models:</b>	ACE04M, ACE05M, ACE10M, ACG10M, AME07D, AME07P, AME10D, APE06, APE07, APG08M, APG10M, AVE07D, AVE07P, AVE10D, AVE10P, AVG05P, AVG10D, AVG20D, BPE044M, BPE044P, BPE054M, BPE054P, BPE064M, BPE064P, BPE074M, BPE074P, BPE084M, BPE084P, BPE104M, BPE104P, BPG044M, BPG044P, BPG054M, BPG054P, BPG064M, BPG064P, BPG074M, BPG074P, BPG084M, BPG084P, BPG104M, BPG104P, CE041M, CE051M, CE071M, CE100M, CE106M, CE110M, CE200M, CE210M...(Other models you can see in the webshop)		

			
1			
<b>GEV No.</b>	690088	<b>Ref. No.</b>	69015010 LAR69015010
<b>description</b>	door handle L 170mm handle ø 16mm spring length 49mm metal complete bolt ø 5mm bolt 13mm		
<b>For models:</b>	CVE004H, CVE004M, CVE104H, CVE104M, ME004L, ME004S, ME104L, ME104S, VE004D, VE004H, VE004M, VE004S, VE004X, VE104D, VE104H, VE104M, VE104S, VE104X		
<b>spare parts for</b>	690088		
	<b>GEV No.</b>	690090	<b>Ref. No.</b> 50004050 69031150 69031190 LA69031190 LAR50004050 LAR69031150 LAR69031190 R50004050 R69031150 R69031190
push button ø 17mm L 16mm M6			
	<b>GEV No.</b>	690091	<b>Ref. No.</b> 50202710 61620041 LA61620041 LAR50202710 LAR61620041 R50202710 R61620041
compression spring ø 12mm L 49mm wire gauge ø 1mm			
	<b>GEV No.</b>	691279	<b>Ref. No.</b> 09200230 LAR09200230 R09200230
door handle			
	<b>GEV No.</b>	691280	<b>Ref. No.</b> 58005340 LA58005340 LAR58005340 R58005340
sealing disc for door handle mounting pos. lower ED ø 25mm ID ø 5.5mm H 5mm			

<b>spare parts for</b>	690088		
	<b>GEV No.</b>	691282	<b>Ref. No.</b> 58005350 LA58005350 LAR58005350 R58005350
gasket for door handle D1 ø 30mm D2 ø 18mm mounting pos. upper H 1.4mm			
	<b>GEV No.</b>	691289	<b>Ref. No.</b> 58004830 LAR58004830 R58004830
nut thread M18x1 H 5mm WS 22 brass Qty 1 pcs for door handle			
<b>accessories for</b>	690088		
	<b>GEV No.</b>	691281	<b>Ref. No.</b> 58004270 LAR58004270 R58004270
spacer piece for door handle L 34mm ID ø 6mm ED ø 8mm			
	<b>GEV No.</b>	692830	<b>Ref. No.</b> 10100100 LA10100100 LAR10100100 R10100100
door catch for combi-steamer L 62mm mounting distance 46mm hole ø 6mm			







			
1			
<b>GEV No.</b>	690087	<b>Ref. No.</b>	69015000 LAR69015000
<b>description</b>	door handle L 170mm handle ø 16mm spring length 49mm metal complete bolt ø 5mm bolt 16mm		
<b>For models:</b>	ACE04M, ACE05M, ACE10M, ACG10M, AME07D, AME07P, AME10D, APE06, APE07, APG08M, APG10M, AVE07D, AVE07P, AVE10D, AVE10P, AVG05P, AVG10D, AVG20D, BPE044M, BPE044P, BPE054M, BPE054P, BPE064M, BPE064P, BPE074M, BPE074P, BPE084M, BPE084P, BPE104M, BPE104P, BPG044M, BPG044P, BPG054M, BPG054P, BPG064M, BPG064P, BPG074M, BPG074P, BPG084M, BPG084P, BPG104M, BPG104P, CE041M, CE051M, CE071M, CE100M, CE106M, CE110M, CE200M, CE210M...(Other models you can see in the webshop)		
<b>spare parts for</b>	690087		
	<b>GEV No.</b>	690090	<b>Ref. No.</b> 50004050 69031150 69031190 LA69031190 LAR50004050 LAR69031150 LAR69031190 R50004050 R69031150 R69031190
push button ø 17mm L 16mm M6			
	<b>GEV No.</b>	690091	<b>Ref. No.</b> 50202710 61620041 LA61620041 LAR50202710 LAR61620041 R50202710 R61620041
compression spring ø 12mm L 49mm wire gauge ø 1mm			
	<b>GEV No.</b>	691279	<b>Ref. No.</b> 09200230 LAR09200230 R09200230
door handle			

Table continues overleaf





<b>spare parts for</b> 690087			
	GEV No.	691280	Ref. No. 58005340 LA58005340 LAR58005340 R58005340
sealing disc for door handle mounting pos. lower ED ø 25mm ID ø 5.5mm H 5mm			
	GEV No.	691282	Ref. No. 58005350 LA58005350 LAR58005350 R58005350
gasket for door handle D1 ø 30mm D2 ø 18mm mounting pos. upper H 1.4mm			
	GEV No.	691283	Ref. No. 58003240 LAR58003240 R58003240
pressure bolt for door handle D1 ø 8mm D2 ø 11mm L 73mm thread M6 bolt 16mm bolt ø 5mm			
	GEV No.	691289	Ref. No. 58004830 LAR58004830 R58004830
nut thread M18x1 H 5mm WS 22 brass Qty 1 pcs for door handle			
<b>accessories for</b> 690087			
	GEV No.	690092	Ref. No. 10100110 LAR10100110 R10100110
door catch L 62mm W 35.5mm H 26.5mm mounting distance 19/46mm			
	GEV No.	691274	Ref. No. 18200940 LA18200940 LAR18200940 R18200940
door catch H 33mm L 40mm W 25mm mounting distance 12mm			
	GEV No.	691275	Ref. No. 18202020 LA18202020 LAR18202020 R18202020
door catch H 45mm W 37mm mounting distance 12mm			
	GEV No.	691281	Ref. No. 58004270 LAR58004270 R58004270
spacer piece for door handle L 34mm ID ø 6mm ED ø 8mm			

	1		
GEV No.	691282	Ref. No.	58005350 LA58005350 LAR58005350
description gasket for door handle D1 ø 30mm D2 ø 18mm mounting pos. upper H 1.4mm			
For models: ACE04M, ACE05M, ACE10M, ACG10M, AME07D, AME07P, AME10D, APE06, APE07, APG08M, APG10M, AVE07D, AVE07P, AVE10D, AVE10P, AVG05P, AVG10D, AVG20D, BPE044M, BPE044P, BPE054M, BPE054P, BPE064M, BPE064P, BPE074M, BPE074P, BPE084M, BPE084P, BPE104M, BPE104P, BPG044M, BPG044P, BPG054M, BPG054P, BPG064M, BPG064P, BPG074M, BPG074P, BPG084M, BPG084P, BPG104M, BPG104P, CE041M, CE051M, CE071M, CE100M, CE106M, CE110M, CE200M, CE210M...(Other models you can see in the webshop)			

	1		
GEV No.	690597	Ref. No.	58002760 LAR58002760
description hook L 33.6mm W 25mm H 25mm mounting distance 12mm			
For models: CE106M, CE110M, CE210M, CG105M, CG106M, CG110M, CG210M, CVE105H, CVE105M, CVG105H, CVG105M, ECO20M, EC106M, EC110M, EC210M, EM006H, EM006M+SC, EM010H, EM010M+SC, EM020M, EM106H, EM106M, EM106M+SC, EM106P, EM110H, EM110M, EM110M+SC, EM110P, EM210H, EM210M, EM210M+SC, EM210P, EV006M, EV006P, EV010H, EV010M, EV010P, EV020M, EV106H, EV106M, EV106M+SC, EV106P, EV110H, EV110M, EV110M+SC, EV110P, EV210H, EV210M, EV210M+SC, EV210P...(Other models you can see in the webshop)			

	1		
GEV No.	691289	Ref. No.	58004830 LAR58004830
description nut thread M18x1 H 5mm WS 22 brass Qty 1 pcs for door handle			
For models: ACE04M, ACE05M, ACE10M, ACG10M, AME07D, AME07P, AME10D, APE06, APE07, APG08M, APG10M, AVE07D, AVE07P, AVE10D, AVE10P, AVG05P, AVG10D, AVG20D, BPE044M, BPE044P, BPE054M, BPE054P, BPE064M, BPE064P, BPE074M, BPE074P, BPE084M, BPE084P, BPE104M, BPE104P, BPG044M, BPG044P, BPG054M, BPG054P, BPG064M, BPG064P, BPG074M, BPG074P, BPG084M, BPG084P, BPG104M, BPG104P, CE041M, CE051M, CE071M, CE100M, CE106M, CE110M, CE200M, CE210M...(Other models you can see in the webshop)			

	1		
GEV No.	691283	Ref. No.	58003240 LAR58003240
description pressure bolt for door handle D1 ø 8mm D2 ø 11mm L 73mm thread M6 bolt 16mm bolt ø 5mm			
For models: ACE04M, ACE05M, ACE10M, ACG10M, AME07D, AME07P, AME10D, APE06, APE07, APG08M, APG10M, AVE07D, AVE07P, AVE10D, AVE10P, AVG05P, AVG10D, AVG20D, BPE044M, BPE044P, BPE054M, BPE054P, BPE064M, BPE064P, BPE074M, BPE074P, BPE084M, BPE084P, BPE104M, BPE104P, BPG044M, BPG044P, BPG054M, BPG054P, BPG064M, BPG064P, BPG074M, BPG074P, BPG084M, BPG084P, BPG104M, BPG104P, CE041M, CE051M, CE071M, CE100M, CE106M, CE110M, CE200M, CE210M...(Other models you can see in the webshop)			

	1		
GEV No.	690090	Ref. No.	50004050 69031150 69031190 LA69031190 LAR50004050 LAR69031150 LAR69031190
description push button ø 17mm L 16mm M6			
For models: ACE04M, ACE05M, ACE10M, ACG10M, AME07D, AME07P, AME10D, APE06, APE07, APG08M, APG10M, AVE07D, AVE07P, AVE10D, AVE10P, AVG05P, AVG10D, AVG20D, BPE044M, BPE044P, BPE054M, BPE054P, BPE064M, BPE064P, BPE074M, BPE074P, BPE084M, BPE084P, BPE104M, BPE104P, BPG044M, BPG044P, BPG054M, BPG054P, BPG064M, BPG064P, BPG074M, BPG074P, BPG084M, BPG084P, BPG104M, BPG104P, CE041M, CE051M, CE071M, CE100M, CE106M, CE110M, CE200M, CE210M...(Other models you can see in the webshop)			



			
1			
<b>GEV No.</b>	691280	<b>Ref. No.</b>	58005340 LA58005340 LAR58005340
<b>description</b>	sealing disc for door handle mounting pos. lower ED ø 25mm ID ø 5.5mm H 5mm		
<b>For models:</b>	ACE04M, ACE05M, ACE10M, ACG10M, AME07D, AME07P, AME10D, APE06, APE07, APG08M, APG10M, AVE07D, AVE07P, AVE10D, AVE10P, AVG05P, AVG10D, AVG20D, BPE044M, BPE044P, BPE054M, BPE054P, BPE064M, BPE064P, BPE074M, BPE074P, BPE084M, BPE084P, BPE104M, BPE104P, BPG044M, BPG044P, BPG054M, BPG054P, BPG064M, BPG064P, BPG074M, BPG074P, BPG084M, BPG084P, BPG104M, BPG104P, CE041M, CE051M, CE071M, CE100M, CE106M, CE110M, CE200M, CE210M...(Other models you can see in the webshop)		



			
1			
<b>GEV No.</b>	691281	<b>Ref. No.</b>	58004270 LAR58004270
<b>description</b>	spacer piece for door handle L 34mm ID ø 6mm ED ø 8mm		
<b>For models:</b>	ACE04M, ACE05M, ACE10M, ACG10M, AME07D, AME07P, AME10D, APE06, APE07, APG08M, APG10M, AVE07D, AVE07P, AVE10D, AVE10P, AVG05P, AVG10D, AVG20D, BPE044M, BPE044P, BPE054M, BPE054P, BPE064M, BPE064P, BPE074M, BPE074P, BPE084M, BPE084P, BPE104M, BPE104P, BPG044M, BPG044P, BPG054M, BPG054P, BPG064M, BPG064P, BPG074M, BPG074P, BPG084M, BPG084P, BPG104M, BPG104P, CE041M, CE051M, CE071M, CE100M, CE106M, CE110M, CE200M, CE210M...(Other models you can see in the webshop)		



			
1			
<b>GEV No.</b>	690095	<b>Ref. No.</b>	50001196 61620012 LA61620012 LAR50001196 LAR61620012
<b>description</b>	torsion spring ø 6mm L2 15mm wire gauge ø 0.9mm L1 2x6mm L3 15mm Qty 1 pcs for closing hub		
<b>For models:</b>	ACE04M, ACE05M, ACE10M, ACG10M, AME07D, AME07P, AME10D, APE06, APE07, APG08M, APG10M, AVE07D, AVE07P, AVE10D, AVE10P, AVG05P, AVG10D, AVG20D, BPE044M, BPE044P, BPE054M, BPE054P, BPE064M, BPE064P, BPE074M, BPE074P, BPE084M, BPE084P, BPE104M, BPE104P, BPG044M, BPG044P, BPG054M, BPG054P, BPG064M, BPG064P, BPG074M, BPG074P, BPG084M, BPG084P, BPG104M, BPG104P, CE041M, CE051M, CE071M, CE100M, CE106M, CE110M, CE200M, CE210M...(Other models you can see in the webshop)		

edgmount latches

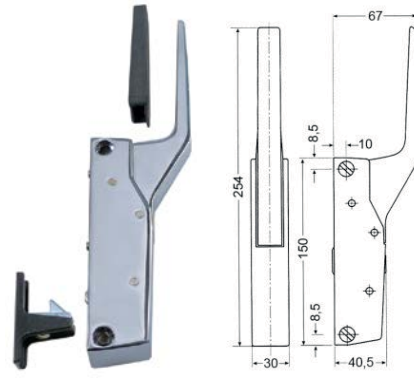
handle latches

CAFF/FERMOD

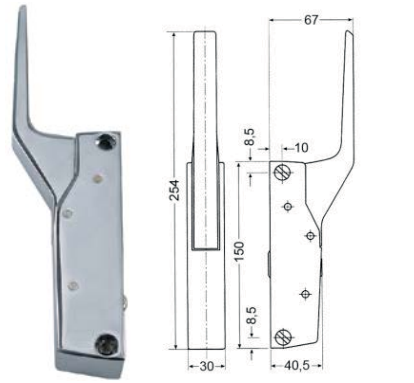
			
1			
<b>GEV No.</b>	701024	<b>Ref. No.</b>	69010010 69010320 LA69010010 LAR69010010 LAR69010320
<b>description</b>	handle latch L 150mm mounting distance 133mm heated units type 790		
<b>For models:</b>	A05PES, A05PES+UM, A05RES, A05RES+UM, A08PES, A08PES+UM, A08RES, A08RES+UM, A10PES, A10PES+UM, A10RES, A10RES+UM		
<b>spare parts for</b>	701024		
	<b>GEV No.</b>	700061	<b>Ref. No.</b> 69015020
	door catch L 58mm W 20mm H 35mm mounting distance 42mm chrome-plated brass for headed units		
	<b>GEV No.</b>	700062	<b>Ref. No.</b> —
	handle protection heated units		





			
1			
<b>GEV No.</b>	700060	<b>Ref. No.</b>	A33200310
<b>description</b>	handle latch L 150mm mounting distance 133mm non lockable heated units G 791		
<b>For models:</b>	RC162M		
<b>accessories for</b>	700060		
	<b>GEV No.</b>	700061	<b>Ref. No.</b> 69015020
	door catch L 58mm W 20mm H 35mm mounting distance 42mm chrome-plated brass for headed units		
	<b>GEV No.</b>	700062	<b>Ref. No.</b> —
	handle protection heated units		

mechanical components, equipment accessories

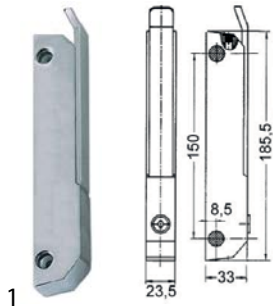
RAHRBACH

6188 ERGO series



<b>GEV No.</b>	700081	<b>Ref. No.</b>	50103010 69010030 LAR50103010 LAR69010030
<b>description</b>	handle latch L 185mm mounting distance 150mm chrome-plated non lockable refrigeration units 6188		
<b>For models:</b>	FV03, FV06		
<b>accessories for</b>	700081		
	<b>GEV No.</b>	690110	<b>Ref. No.</b> —
	base plate H 1mm L 38mm W 11mm mounting distance 26mm plastic		
	<b>GEV No.</b>	690111	<b>Ref. No.</b> —
	base plate H 2mm L 38mm W 11mm mounting distance 26mm plastic		
	<b>GEV No.</b>	690114	<b>Ref. No.</b> —
	base plate H 3.5mm L 185mm W 30mm mounting distance 150mm with inclination thread M5		
	<b>GEV No.</b>	700082	<b>Ref. No.</b> 50103020 69010500 LAR50103020 LAR69010500 R50103020 R69010500
	door catch L 38mm W 18mm mounting distance 26mm		

door catches



<b>GEV No.</b>	700082	<b>Ref. No.</b>	50103020 69010500 LAR50103020 LAR69010500
<b>description</b>	door catch L 38mm W 18mm mounting distance 26mm		
<b>For models:</b>	FV03, FV06		



<b>GEV No.</b>	700061	<b>Ref. No.</b>	69015020
<b>description</b>	door catch L 58mm W 20mm H 35mm mounting distance 42mm chrome-plated brass for headed units		
<b>accessories for</b>	700061		
	<b>GEV No.</b>	690414	<b>Ref. No.</b> —
	handle latch L 150mm mounting distance 133mm non lockable refrigeration units G 791		

snap locks

universal



<b>GEV No.</b>	690596	<b>Ref. No.</b>	50103110 69050010 LA69050010 LAR50103110 LAR69050010
<b>description</b>	snap lock L 60mm W 15mm H 36mm mounting distance 48/28mm spring thickness 1.5mm complete with door catch zamak		
<b>For models:</b>	FE05, FG05, ME05, ME10, ME20, MG05, MG10, MG20, MME05, MME10, PE04, PE08, PG04, PG08, RE05, RE07, RE10, RE20, REC023M, RG05, RG07, RG10, RG20		

producer-specific

LAINOX



<b>GEV No.</b>	694586	<b>Ref. No.</b>	69050020 LAR69050020 RZ960029 SIRRZ960029
<b>description</b>	snap lock repair set		





espagnolette locks









universal









<b>GEV No.</b>	690040	<b>Ref. No.</b>	5900122
<b>description</b>	door catch with roller H 42mm L 40mm W 40mm zinc die cast mounting distance 26mm type 0751 series		
<b>For models:</b>	VE102MX		









producer-specific			
LAINOX			
group 1			
 <p>1</p>			
<b>GEV No.</b>	690591	<b>Ref. No.</b>	03200970 50001190 58003150 LA03200970 LAR03200970 LAR50001190 LAR58003150
<b>description</b>	base plate H 12mm L 60mm W 45mm mounting distance 30/40mm hole ø 12mm		
<b>For models:</b>	ABE156X, ABG156S, AREN154, ARES154, ARGN154, ARGS154, CEC40M, CES24M, CES40M, CGC24M, CGC40M, CGS24M, CGS40M, EMT21P, EPE156T, EPEV15T, EPG156T, EPGV15T, FME201SX, FMG201A, FMG201S, GEMT21P, GEMT21S, GEMT21T, GEMT21X, GEMT40P, GEMT40S, GEMT40T, GEMT40X, GEVT21P, GEVT21S, GEVT21T, GEVT21X, GEVT40P, GEVT40S, GEVT40T, GEVT40X, GGMT21P, GGMT21S, GGMT21T, GGMT21X, GGMT40P, GGMT40S, GGMT40T, GGMT40X, GGVT21P, GGVT21S, GGVT21T, GGVT21X, GGVT40P...(Other models you can see in the webshop)		
 <p>1</p>			
<b>GEV No.</b>	694990	<b>Ref. No.</b>	11205340 LAR11205340
<b>description</b>	cross bar with coupling for espagnolette lock		
<b>For models:</b>	ABE156X, ABG156S, AREN154, ARES154, ARGN154, ARGS154, EMT21P, EPE156T, EPEV15T, EPG156T, EPGV15T, GEMT21P, GEMT21S, GEMT21T, GEMT21X, GEMT40P, GEMT40S, GEMT40T, GEMT40X, GEVT21P, GEVT21S, GEVT21T, GEVT21X, GEVT40P, GEVT40S, GEVT40T, GEVT40X, GGMT21P, GGMT21S, GGMT21T, GGMT21X, GGMT40P, GGMT40S, GGMT40T, GGMT40X, GGVT21P, GGVT21S, GGVT21T, GGVT21X, GGVT40P, GGVT40S, GGVT40T, GGVT40X, GSE201N, HME201P, HME201S, HME201T, HME201X, HME202P, HME202S...(Other models you can see in the webshop)		
 <p>1</p>			
<b>GEV No.</b>	694316	<b>Ref. No.</b>	11100310 11100340 LAR11100310 LAR11100340
<b>description</b>	door handle for espagnolette lock L 205mm H 65mm handle ø 60mm		
<b>For models:</b>	ABE156X, ABG156S, EMT21P, EPE156T, EPEV15T, EPG156T, EPGV15T, GEMT21P, GEMT21T, GEMT40P, GEMT40T, GEVT21P, GEVT21T, GEVT40P, GEVT40T, GGMT21P, GGMT21T, GGMT40P, GGMT40T, GGVT21P, GGVT21T, GGVT40P, GGVT40T, GSE201N, HME201P, HME201S, HME201T, HME201X, HME202P, HME202S, HME202T, HME202X, HMG201P, HMG201T, HMG201X, HMG202P, HMG202T, HMG202X, HVE201P, HVE201S, HVE201T, HVE201X, HVE202P, HVE202T, HVE202X, HVG201P, HVG201T, HVG201X, HVG202P, HVG202T...(Other models you can see in the webshop)		
<b>spare parts for</b>	694316		
	<b>GEV No.</b>	560289	<b>Ref. No.</b> —
	side bolts thread M6 L 12mm SS Qty 1 pcs intake Phillips head ø 12.6mm		

<b>spare parts for</b>	694316		
	<b>GEV No.</b>	560540	<b>Ref. No.</b> —
	countersunk screw ø 5mm L 120mm SS Qty 1 pcs intake Phillips for door handle		
	<b>GEV No.</b>	560542	<b>Ref. No.</b> —
	grub screw thread M6 L 16mm in stainless steel DIN 916/ISO 4029 intake internal hexagon WS 3 Qty 1 pcs		
	<b>GEV No.</b>	690591	<b>Ref. No.</b> 03200970 50001190 58003150 LA03200970 LAR03200970 LAR50001190 LAR58003150 R03200970 R50001190 R58003150
	base plate H 12mm L 60mm W 45mm mounting distance 30/40mm hole ø 12mm		
	<b>GEV No.</b>	694611	<b>Ref. No.</b> 69010600 69010640 LAR69010600 LAR69010640 R69010600 R69010640
	tap head for door handle ø 60mm grey L 105mm W 60mm H 65mm		
	<b>GEV No.</b>	694624	<b>Ref. No.</b> 69010610 69010650 LAR69010610 LAR69010650 R69010610
	door handle L 185mm handle ø 28mm screw mounting dark grey plastic hole ø 6mm		
	<b>GEV No.</b>	694625	<b>Ref. No.</b> —
	coupling for door handle ø 20mm L 28mm hole ø 11mm		
	<b>GEV No.</b>	694626	<b>Ref. No.</b> —
	cross bar H 17mm L 107mm W 50mm for espagnolette lock mounting distance 40mm D1 ø 11mm D2 ø 12mm		
	<b>GEV No.</b>	694627	<b>Ref. No.</b> —
	thread bolt L 13.5mm for espagnolette lock D1 ø 11mm D2 ø 10mm thread M6		
	<b>GEV No.</b>	694630	<b>Ref. No.</b> —
	bush H 9mm for espagnolette lock ID ø 10mm ED ø 14mm		



			
<b>GEV No.</b>	694624	<b>Ref. No.</b>	69010610 69010650 LAR69010610 LAR69010650
<b>description</b>	door handle L 185mm handle ø 28mm screw mounting dark grey plastic hole ø 6mm		
<b>For models:</b>	ABE156X, ABG156S, EMT21P, EPE156T, EPEV15T, EPG156T, EPGV15T, GEMT21P, GEMT21T, GEMT40P, GEMT40T, GEVT21P, GEVT21T, GEVT40P, GEVT40T, GGMT21P, GGMT21T, GGMT40P, GGMT40T, GGV21P, GGV21T, GGV240P, GGV240T, GSE201N, HME201P, HME201S, HME201T, HME201X, HME202P, HME202S, HME202T, HME202X, HMG201P, HMG201T, HMG201X, HMG202P, HMG202T, HMG202X, HVE201P, HVE201S, HVE201T, HVE201X, HVE202P, HVE202T, HVE202X, HVG201P, HVG201T, HVG201X, HVG202P, HVG202T...(Other models you can see in the webshop)		
<b>spare parts for</b>	694624		
	<b>GEV No.</b>	560540	<b>Ref. No.</b> —
	countersunk screw ø 5mm L 120mm SS Qty 1 pcs intake Phillips for door handle		
<b>accessories for</b>	694624		
	<b>GEV No.</b>	560540	<b>Ref. No.</b> —
	countersunk screw ø 5mm L 120mm SS Qty 1 pcs intake Phillips for door handle		
	<b>GEV No.</b>	694611	<b>Ref. No.</b> 69010600 69010640 LAR69010600 LAR69010640 R69010600 R69010640
	tap head for door handle ø 60mm grey L 105mm W 60mm H 65mm		
	<b>GEV No.</b>	694625	<b>Ref. No.</b> —
	coupling for door handle ø 20mm L 28mm hole ø 11mm		
	<b>GEV No.</b>	694626	<b>Ref. No.</b> —
	cross bar H 17mm L 107mm W 50mm for espagnolette lock mounting distance 40mm D1 ø 11mm D2 ø 12mm		
	<b>GEV No.</b>	694630	<b>Ref. No.</b> —
	bush H 9mm for espagnolette lock ID ø 10mm ED ø 14mm		

			
<b>GEV No.</b>	560541	<b>Ref. No.</b>	61040272 LA61050102 LAR61040272
<b>description</b>	raised countersunk head screw thread M6 thread L 13mm SS DIN 966/ISO 7047 Qty 1 pcs intake slotted head ø 11mm head thickness 5mm		
<b>For models:</b>	ABE156X, ABG156S, CEC40M, CES24M, CES40M, CGC24M, CGC40M, CGS24M, CGS40M, EMT21P, EPE156T, EPEV15T, EPG156T, EPGV15T, FME201SX, GEMT21P, GEMT21T, GEMT40P, GEMT40T, GEVT21P, GEVT21T, GEVT40P, GEVT40T, GGMT21P, GGMT21T, GGMT40P, GGMT40T, GGV21P, GGV21T, GGV240P, GGV240T, GSE201N, HME201P, HME201S, HME201T, HME201X, HME202P, HME202S, HME202T, HME202X, HMG201P, HMG201T, HMG201X, HMG202P, HMG202T, HMG202X, HVE201P, HVE201S, HVE201T, HVE201X...(Other models you can see in the webshop)		

			
<b>GEV No.</b>	694611	<b>Ref. No.</b>	69010600 69010640 LAR69010600 LAR69010640
<b>description</b>	tap head for door handle ø 60mm grey L 105mm W 60mm H 65mm		
<b>For models:</b>	ABE156X, ABG156S, EMT21P, EPE156T, EPEV15T, EPG156T, EPGV15T, GEMT21P, GEMT21T, GEMT40P, GEMT40T, GEVT21P, GEVT21T, GEVT40P, GEVT40T, GGMT21P, GGMT21T, GGMT40P, GGMT40T, GGV21P, GGV21T, GGV240P, GGV240T, GSE201N, HME201P, HME201S, HME201T, HME201X, HME202P, HME202S, HME202T, HME202X, HMG201P, HMG201T, HMG201X, HMG202P, HMG202T, HMG202X, HVE201P, HVE201S, HVE201T, HVE201X, HVE202P, HVE202T, HVE202X, HVG201P, HVG201T, HVG201X, HVG202P, HVG202T...(Other models you can see in the webshop)		
<b>accessories for</b>	694611		
	<b>GEV No.</b>	560540	<b>Ref. No.</b> —
	countersunk screw ø 5mm L 120mm SS Qty 1 pcs intake Phillips for door handle		
	<b>GEV No.</b>	694624	<b>Ref. No.</b> 69010610 69010650 LAR69010610 LAR69010650 R69010610
	door handle L 185mm handle ø 28mm screw mounting dark grey plastic hole ø 6mm		
	<b>GEV No.</b>	694625	<b>Ref. No.</b> —
	coupling for door handle ø 20mm L 28mm hole ø 11mm		
	<b>GEV No.</b>	694626	<b>Ref. No.</b> —
	cross bar H 17mm L 107mm W 50mm for espagnolette lock mounting distance 40mm D1 ø 11mm D2 ø 12mm		

<b>group 2</b>			
			
<b>GEV No.</b>	690591	<b>Ref. No.</b>	03200970 50001190 58003150 LA03200970 LAR03200970 LAR50001190 LAR58003150
<b>description</b>	base plate H 12mm L 60mm W 45mm mounting distance 30/40mm hole ø 12mm		
<b>For models:</b>	ABE156X, ABG156S, AREN154, ARES154, ARGN154, ARG154, CEC40M, CES24M, CES40M, CGC24M, CGC40M, CGS24M, CGS40M, EMT21P, EPE156T, EPEV15T, EPG156T, EPGV15T, FME201SX, FMG201A, FMG201S, GEMT21P, GEMT21S, GEMT21T, GEMT21X, GEMT40P, GEMT40S, GEMT40T, GEMT40X, GEVT21P, GEVT21S, GEVT21T, GEVT21X, GEVT40P, GEVT40S, GEVT40T, GEVT40X, GGMT21P, GGMT21S, GGMT21T, GGMT21X, GGMT40P, GGMT40S, GGMT40T, GGMT40X, GGV21P, GGV21T, GGV240P, GGV240T, GSE201N, HME201P, HME201S, HME201T, HME201X, HME202P, HME202S, HME202T, HME202X, HMG201P, HMG201T, HMG201X, HMG202P, HMG202T, HMG202X, HVE201P, HVE201S, HVE201T, HVE201X...(Other models you can see in the webshop)		







			
1			
<b>GEV No.</b>	690589	<b>Ref. No.</b>	50001140 58000990 LAR50001140 LAR58000990
<b>description</b>	bush for door mechanism L 18mm ED ø 22mm ID ø 12mm D1 ø 20mm		
<b>For models:</b>	ME15, ME21, ME24, ME40, MG15, MG21, MG24, MG40, MME40, PE12, PG12, RE24, RG24, RG40		

			
1			
<b>GEV No.</b>	690590	<b>Ref. No.</b>	50001160 58004780 LAR50001160 LAR58004780
<b>description</b>	catch hook L 13mm ø 12mm M6 bolt ø 10mm		
<b>For models:</b>	FMG201A, FMG201S, ME120L, ME120S, ME120T, ME15, ME21, ME220L, ME220S, ME220T, ME24, ME40, MG120L, MG120S, MG120T, MG15, MG21, MG220L, MG220S, MG220T, MG24, MG40, MME40, PE12, PG12, RE24, RG24, RG40, VE120L, VE120S		

			
1			
<b>GEV No.</b>	694315	<b>Ref. No.</b>	10202960 LA10202960 LAR10202960
<b>description</b>	closing rod ø 12mm L 755mm		
<b>For models:</b>	CEC40M, CES40M, CGC40M, CGS40M, FME201SX, FMG201A, FMG201S, ME120D, ME120H, ME120L, ME120M, ME120P, ME120S, ME120T, ME120X, ME220D, ME220H, ME220L, ME220M, ME220P, ME220S, ME220T, ME220X, MEC20H, MEC20P, MEC20X, MEC40H, MEC40M, MEC40P, MED40D, MEK21H, MES20D, MES20H, MES20M, MES20P, MES20X, MES40D, MES40H, MES40M, MES40P, MES40X, MG120D, MG120H, MG120L, MG120M, MG120P, MG120S, MG120T, MG120X, MG220D...(Other models you can see in the webshop)		

			
1			
<b>GEV No.</b>	694314	<b>Ref. No.</b>	10202950 LA10202950 LAR10202950
<b>description</b>	closing rod ø 12mm L 785mm		
<b>For models:</b>	CEC40M, CES40M, CGC40M, CGS40M, FME201SX, FMG201A, FMG201S, ME120D, ME120H, ME120L, ME120M, ME120P, ME120S, ME120T, ME120X, ME220D, ME220H, ME220L, ME220M, ME220P, ME220S, ME220T, ME220X, MEC20H, MEC20P, MEC20X, MEC40H, MEC40M, MEC40P, MED40D, MEK21H, MES20D, MES20H, MES20M, MES20P, MES20X, MES40D, MES40H, MES40M, MES40P, MES40X, MG120D, MG120H, MG120L, MG120M, MG120P, MG120S, MG120T, MG120X, MG220D...(Other models you can see in the webshop)		



			
1			
<b>GEV No.</b>	694286	<b>Ref. No.</b>	11205381 LA11205381 LAR11205381
<b>description</b>	closing rod ø 12mm L 820mm		
<b>For models:</b>	ABE156X, ABG156S, EMT21P, EPE156T, EPEV15T, EPG156T, EPGV15T, GEMT21P, GEMT21T, GEMT40P, GEMT40T, GEVT21P, GEVT21T, GEVT40P, GEVT40T, GGMT21P, GGMT21T, GGMT40P, GGMT40T, GGVT21P, GGVT21T, GGVT40P, GGVT40T, GSE201N, HME201P, HME201S, HME201T, HME201X, HME202P, HME202S, HME202T, HME202X, HMG201P, HMG201T, HMG201X, HMG202P, HMG202T, HMG202X, HVE201P, HVE201S, HVE201T, HVE201X, HVE202P, HVE202T, HVE202X, HVG201P, HVG201T, HVG201X, HVG202P, HVG202T...(Other models you can see in the webshop)		

			
1			
<b>GEV No.</b>	694285	<b>Ref. No.</b>	11205370 LA11205370 LAR11205370
<b>description</b>	closing rod ø 12mm L 840mm		
<b>For models:</b>	ABE156X, ABG156S, EMT21P, EPE156T, EPEV15T, EPG156T, EPGV15T, GEMT21P, GEMT21T, GEMT40P, GEMT40T, GEVT21P, GEVT21T, GEVT40P, GEVT40T, GGMT21P, GGMT21T, GGMT40P, GGMT40T, GGVT21P, GGVT21T, GGVT40P, GGVT40T, GSE201N, HME201P, HME201S, HME201T, HME201X, HME202P, HME202S, HME202T, HME202X, HMG201P, HMG201T, HMG201X, HMG202P, HMG202T, HMG202X, HVE201P, HVE201S, HVE201T, HVE201X, HVE202P, HVE202T, HVE202X, HVG201P, HVG201T, HVG201X, HVG202P, HVG202T...(Other models you can see in the webshop)		

			
1			
<b>GEV No.</b>	690089	<b>Ref. No.</b>	69015050 LAR69015050
<b>description</b>	door handle L 155mm W 75mm handle ø 40mm stainless steel complete mounting distance 30mm		
<b>For models:</b>	CEC40M, CES24M, CES40M, CGC24M, CGC40M, CGS24M, CGS40M, FME201SX, ME120D, ME120H, ME120L, ME120M, ME120P, ME120X, ME220D, ME220H, ME220M, ME220P, ME220X, MEC20H, MEC20P, MEC20X, MEC24H, MEC40H, MEC40M, MEC40P, MED40D, MEK21H, MES20D, MES20H, MES20M, MES20P, MES20X, MES24D, MES24H, MES24M, MES24P, MES24X, MES40D, MES40H, MES40M, MES40P, MES40X, MG120D, MG120H, MG120M, MG120P, MG120X, MG220D, MG220H, MG220M...(Other models you can see in the webshop)		

mechanical components, equipment accessories

			
<b>1</b>			
<b>GEV No.</b>	560024	<b>Ref. No.</b>	61090052 LA61090052 LAR61090052
<b>description</b>	grub screw thread M6 L 16mm SS DIN 913/ISO 4026 intake internal hexagon WS 3 Qty 20 pcs		
<b>For models:</b>	ABE156X, ABG156S, CEC40M, CES24M, CES40M, CGC24M, CGC40M, CGS24M, CGS40M, EMT21P, EPE156T, EPEV15T, EPG156T, EPGV15T, FME201SX, GEMT21P, GEMT21S, GEMT21T, GEMT21X, GEMT40P, GEMT40S, GEMT40T, GEMT40X, GEVT21P, GEVT21S, GEVT21T, GEVT21X, GEVT40P, GEVT40S, GEVT40T, GEVT40X, GGMT21P, GGMT21S, GGMT21T, GGMT21X, GGMT40P, GGMT40S, GGMT40T, GGMT40X, GGV21P, GGV21S, GGV21T, GGV21X, GGV40P, GGV40S, GGV40T, GGV40X, GSE201N, HME201P, HME201S...(Other models you can see in the webshop)		

			
<b>2</b>			
<b>GEV No.</b>	694317	<b>Ref. No.</b>	58004781 LAR58004781
<b>description</b>	hook for door bolt M6		
<b>For models:</b>	ABE156X, ABG156S, AREN154, ARES154, ARGN154, ARG5154, CEC40M, CES24M, CES40M, CGC24M, CGC40M, CGS24M, CGS40M, EMT21P, EPE156T, EPEV15T, EPG156T, EPGV15T, FME201SX, GEMT21P, GEMT21S, GEMT21T, GEMT21X, GEMT40P, GEMT40S, GEMT40T, GEMT40X, GEVT21P, GEVT21S, GEVT21T, GEVT21X, GEVT40P, GEVT40S, GEVT40T, GEVT40X, GGMT21P, GGMT21S, GGMT21T, GGMT21X, GGMT40P, GGMT40S, GGMT40T, GGMT40X, GGV21P, GGV21S, GGV21T, GGV21X, GGV40P, GGV40S, GGV40T, GGV40X...(Other models you can see in the webshop)		
<b>spare parts for</b>	694317		
	<b>GEV No.</b>	694627	<b>Ref. No.</b> —
	thread bolt L 13.5mm for espagnolette lock D1 ø 11mm D2 ø 10mm thread M6		
	<b>GEV No.</b>	694630	<b>Ref. No.</b> —
	bush H 9mm for espagnolette lock ID ø 10mm ED ø 14mm		

			
<b>1</b>			
<b>GEV No.</b>	697933	<b>Ref. No.</b>	61420021 LAR61420021
<b>description</b>	spring washer ID ø 13mm ED ø 24mm Qty 1 pcs		
<b>For models:</b>	ABE156X, ABG156S, CEC40M, CES24M, CES40M, CGC24M, CGC40M, CGS24M, CGS40M, EMT21P, EPE156T, EPEV15T, EPG156T, EPGV15T, FME201SX, FMG201A, FMG201S, GEMT21P, GEMT21T, GEMT40P, GEMT40T, GEVT21P, GEVT21T, GEVT40P, GEVT40T, GGMT21P, GGMT21T, GGMT40P, GGMT40T, GGV21P, GGV21T, GGV40P, GGV40T, GSE201N, HME201P, HME201S, HME201T, HME201X, HME202P, HME202S, HME202T, HME202X, HMG201P, HMG201T, HMG201X, HMG202P, HMG202T, HMG202X, HVE201P, HVE201S...(Other models you can see in the webshop)		

			
<b>1</b>			
<b>GEV No.</b>	697934	<b>Ref. No.</b>	67011050 LAR67011050
<b>description</b>	sticker for door handle ø 20mm dark blue		
<b>For models:</b>	LA10, LA16, LA18, LV10, LV16, LV18, PE015M, PG015D, PG015K, PG115D, PG115K, PG115M, PG115T		

miscellaneous

			
<b>1</b>			
<b>GEV No.</b>	691286	<b>Ref. No.</b>	58001780 LAR58001780
<b>description</b>	catch for glass plate		
<b>For models:</b>	ABE044M, ABE054M, ABE084S, ABE104S, ABE156X, ABG064M, ABG074M, ABG084X, ABG104X, ABG156S, ACE10M, ACG10M, AME07D, AME07P, AME10D, APE06, APE07, APG08M, APG10M, AREN064, AREN084, AREN154, ARES064, ARES084, ARES154, ARGN064, ARGN084, ARGN154, ARS064, ARS084, ARS154, AVE07D, AVE07P, AVE10D, AVE10P, AVG10D, AVG20D, BPE064M, BPE064P, BPE074M, BPE074P, BPE084M, BPE084P, BPE104M, BPE104P, BPG064M, BPG064P, BPG074M, BPG074P, BPG084M...(Other models you can see in the webshop)		

hinges

door bearing

			
<b>1</b>			
<b>GEV No.</b>	691288	<b>Ref. No.</b>	58002520 LA58002520 LAR58002520
<b>description</b>	door bolt		
<b>For models:</b>	ABE044M, ABE054M, ABE084S, ABE104S, ABG064M, ABG074M, ABG084X, ABG104X, ACE10M, ACG10M, AME07D, AME07P, AME10D, APE06, APE07, APG08M, APG10M, AVE07D, AVE07P, AVE10D, AVE10P, AVG10D, AVG20D, BPE064M, BPE064P, BPE074M, BPE074P, BPE084M, BPE084P, BPE104M, BPE104P, BPG064M, BPG064P, BPG074M, BPG074P, BPG084M, BPG084P, BPG104M, BPG104P, CE071M, CE100M, CE200M, CG071M, CG100M, CG200M, CVE024S, CVE024X, EMT06D, EMT10D, EMT20P...(Other models you can see in the webshop)		

			
<b>1</b>			
<b>GEV No.</b>	692831	<b>Ref. No.</b>	58002670 LA58002670 LAR58002670
<b>description</b>	door bolt mounting pos. bottom left thread M12 bolt 15mm bolt ø 10mm		
<b>For models:</b>	AREN064, AREN084, ARES064, ARES084, ARGN064, ARGN084, ARS064, ARS084, CBEN061, CBES061, CEV026S, CEV026X, CEV061S, CEV061X, CEV101S, CEV101X, CKES10, CME061S, CME061X, COEN026, COEN061, COEN101, COES026, COES061, COES101, CVE061S, CVE061X, CVEN061, CVES061, CVG061S, CVG061X, CVGN061, CVGS061, EMT06D, EMT20P, EPE056T, EPE086T, EPEV05T, EPEV08T, EPG056T, EPG086T, EPGV05T, EPGV08T, EVT06D, EVT20D, GEMT06P, GEMT06T, GEMT07S, GEMT07X, GEMT10P...(Other models you can see in the webshop)		



			
1			
<b>GEV No.</b>	690098	<b>Ref. No.</b>	10201330 LAR10201330
<b>description</b>	door hinge mounting pos. lower with holder		
<b>For models:</b>	CEC40M, CES24M, CES40M, CGC24M, CGC40M, CGS24M, CGS40M, FME201SX, ME120D, ME120H, ME120M, ME120P, ME120X, ME220D, ME220H, ME220M, ME220P, ME220X, MEC20H, MEC20P, MEC20X, MEC24H, MEC40H, MEC40M, MEC40P, MED40D, MEK21H, MES20D, MES20H, MES20M, MES20P, MES20X, MES24D, MES24H, MES24M, MES24P, MES24X, MES40D, MES40H, MES40M, MES40P, MES40X, MG120D, MG120H, MG120M, MG120P, MG120X, MG220D, MG220H, MG220M...(Other models you can see in the webshop)		

			
1			
<b>GEV No.</b>	691287	<b>Ref. No.</b>	18404500 LAR18404500
<b>description</b>	hinge		
<b>For models:</b>	ABE084S, ABE104S, ABG064M, ABG074M, ABG084X, ABG104X, ACE10M, ACG10M, AME07D, AME07P, AME10D, APE06, APE07, APG08M, APG10M, AVE07D, AVE07P, AVE10D, AVE10P, AVG10D, AVG20D, BPE064M, BPE064P, BPE074M, BPE074P, BPE084M, BPE084P, BPE104M, BPE104P, BPG064M, BPG064P, BPG074M, BPG074P, BPG084M, BPG084P, BPG104M, BPG104P, CE071M, CE100M, CE200M, CG071M, CG100M, CG200M, EVEA20S, MACE07M, MACE10M, MACE20M, MACG07M, MACG10M, MACG20M...(Other models you can see in the webshop)		

			
1			
<b>GEV No.</b>	690097	<b>Ref. No.</b>	10201290 LA10201290 LAR10201290
<b>description</b>	door hinge mounting pos. upper		
<b>For models:</b>	CE106M, CE110M, CE210M, CG106M, CG110M, CG210M, FEI102P, FME101AX, FME201SX, ME106D, ME106H, ME106M, ME106P, ME106X, ME110D, ME110H, ME110M, ME110P, ME110X, ME120D, ME120H, ME120M, ME120P, ME120X, ME210D, ME210H, ME210M, ME210P, ME210X, ME227M, ME227P, ME227X, MEC20H, MEC20P, MEC20X, MEK21H, MES20D, MES20H, MES20M, MES20P, MES20X, MG106D, MG106H, MG106M, MG106P, MG106X, MG110D, MG110H, MG110M, MG110P...(Other models you can see in the webshop)		

			
1			
<b>GEV No.</b>	691284	<b>Ref. No.</b>	58001760 LA58001760 LAR58001760
<b>description</b>	hinge for glass plate		
<b>For models:</b>	ABE044M, ABE054M, ABE084S, ABE104S, ABE156X, ABG064M, ABG074M, ABG084X, ABG104X, ABG156S, ACE10M, ACG10M, AME07D, AME07P, AME10D, APE06, APE07, APG08M, APG10M, AREN064, AREN084, AREN154, ARES064, ARES084, ARES154, ARGN064, ARGN084, ARGN154, ARGS064, ARGS084, ARGS154, AVE07D, AVE07P, AVE10D, AVE10P, AVG10D, AVG20D, BPE064M, BPE064P, BPE074M, BPE074P, BPE084M, BPE084P, BPE104M, BPE104P, BPG064M, BPG064P, BPG074M, BPG074P, BPG084M...(Other models you can see in the webshop)		

			
1			
<b>GEV No.</b>	692828	<b>Ref. No.</b>	17400540 LA17400540 LAR17400540
<b>description</b>	door hinge upper for combi-steamer L 63mm W 35mm H 31mm		
<b>For models:</b>	A05PES, A05PES+UM, A05RES, A05RES+UM, A08PES, A08PES+UM, A08RES, A08RES+UM, A10PES, A10PES+UM, A10RES, A10RES+UM, REC023M		

			
1			
<b>GEV No.</b>	694388	<b>Ref. No.</b>	12200630 LA12200630 LAR12200630
<b>description</b>	hinge L 130mm W 35mm H 22mm mounting pos. lower with bolt suitable for oven		
<b>For models:</b>	PE005D, PE005K, PE005M, PE008D, PE008K, PE008M, PE105D, PE105K, PE105M, PE105T, PE108D, PE108K, PE108M, PE108T, PG005D, PG005K, PG005M, PG008D, PG008K, PG008M, PG105D, PG105K, PG105M, PG105T, PG108D, PG108K, PG108M, PG108T		

mechanical components, equipment accessories



1

<b>GEV No.</b>	691277	<b>Ref. No.</b>	18201270 LA18201270 LAR18201270
<b>description</b>	hinge mounting pos. bottom left		
<b>For models:</b>	ACE04M, ACE05M, AVG05P, BPE044M, BPE044P, BPE054M, BPE054P, BPG044M, BPG044P, BPG054M, BPG054P, CE041M, CE051M, CG051M, MACE04M, MACE05M, MACG05M, MCE042M, MCE051M, MCG051M, MVE042P, MVE051P, MVG051P, PE044M, PE054M, VE042P, VE051P, VE055P, VG051P		



2

<b>GEV No.</b>	690587	<b>Ref. No.</b>	11200550 11200551 LA11200551 LAR11200550 LAR11200551
<b>description</b>	hinge bearing mounting pos. lower with bolt		
<b>For models:</b>	ME061H, ME061M, ME061P, ME061T, ME101H, ME101M, ME101P, ME101T, ME102H, ME102M, ME102P, ME102T, MG061H, MG061M, MG061P, MG061T, MG101H, MG101M, MG101P, MG101T, MG102H, MG102M, MG102P, MG102T		



1

<b>GEV No.</b>	690096	<b>Ref. No.</b>	10201190 LAR10201190
<b>description</b>	hinge bearing mounting pos. lower without bolt		
<b>For models:</b>	CE106M, CE110M, CE210M, CG106M, CG110M, CG210M, FEI102P, FME101AX, ME106D, ME106H, ME106M, ME106P, ME106X, ME110D, ME110H, ME110M, ME110P, ME110X, ME210D, ME210H, ME210M, ME210P, ME210X, MG106D, MG106H, MG106M, MG106P, MG106X, MG110D, MG110H, MG110M, MG110P, MG110X, MG210D, MG210H, MG210M, MG210P, MG210X, VE106D, VE106H, VE106M, VE106P, VE106X, VE110D, VE110H, VE110M, VE110P, VE110X, VE210D, VE210H...(Other models you can see in the webshop)		



1

<b>GEV No.</b>	691276	<b>Ref. No.</b>	18201260 LA18201260 LAR18201260
<b>description</b>	hinge bearing mounting pos. upper left		
<b>For models:</b>	ACE04M, ACE05M, AVG05P, BPE044M, BPE044P, BPE054M, BPE054P, BPG044M, BPG044P, BPG054M, BPG054P, CE041M, CE051M, CG051M, MACE04M, MACE05M, MACG05M, MCE042M, MCE051M, MCG051M, MVE042P, MVE051P, MVG051P, PE044M, PE054M, VE042P, VE051P, VE055P, VG051P		



1

<b>GEV No.</b>	690586	<b>Ref. No.</b>	11200560 LA1142683 LAR11200560 R11426830
<b>description</b>	hinge bearing mounting pos. upper left without bolt		
<b>For models:</b>	ABE156X, ABG156S, ACE10M, ACG10M, AME07D, AME07P, AME10D, APE06, APE07, APG08M, APG10M, AVE07D, AVE07P, AVE10D, AVE10P, AVG10D, AVG20D, BPE064M, BPE064P, BPE074M, BPE074P, BPE084M, BPE084P, BPE104M, BPE104P, BPG064M, BPG064P, BPG074M, BPG074P, BPG084M, BPG084P, BPG104M, BPG104P, CE071M, CE100M, CE200M, CG071M, CG100M, CG200M, EMT06D, EMT10D, EMT20P, EMT21P, EPE056T, EPE086T, EPE156T, EPEV05T, EPEV08T, EPEV15T, EPG056T...(Other models you can see in the webshop)		



1

<b>GEV No.</b>	514524	<b>Ref. No.</b>	11207240 LA11207240 LAR11207240
<b>description</b>	hinge bearing without bolt for combi-steamer mounting pos. bottom left		
<b>For models:</b>	AREN064, AREN084, ARES064, ARES084, ARGN064, ARGN084, ARG064, ARG084, CBEN061, CBES061, CKES10, CME061S, CME061X, CVE061S, CVE061X, CVEN061, CVES061, CVG061S, CVG061X, CVGN061, CVGS061, EMT06D, EMT20P, EPE056T, EPE086T, EPEV05T, EPEV08T, EPG056T, EPG086T, EPGV05T, EPGV08T, EVT06D, EVT20D, GEMT06P, GEMT06T, GEMT07S, GEMT07X, GEMT10P, GEMT10S, GEMT10T, GEMT10X, GEMT20P, GEMT20S, GEMT20T, GEMT20X, GEVT06P, GEVT06S, GEVT06T, GEVT07S, GEVT07X...(Other models you can see in the webshop)		



1

<b>GEV No.</b>	691285	<b>Ref. No.</b>	58001770 LA58001770 LAR58001770
<b>description</b>	hinge bolt		
<b>For models:</b>	ABE044M, ABE054M, ABE084S, ABE104S, ABE156X, ABG064M, ABG074M, ABG084X, ABG104X, ABG156S, ACE10M, ACG10M, AME07D, AME07P, AME10D, APE06, APE07, APG08M, APG10M, AREN064, AREN084, AREN154, ARES064, ARES084, ARES154, ARGN064, ARGN084, ARGN154, ARG064, ARG084, ARG154, AVE07D, AVE07P, AVE10D, AVE10P, AVG10D, AVG20D, BPE064M, BPE064P, BPE074M, BPE074P, BPE084M, BPE084P, BPE104M, BPE104P, BPG064M, BPG064P, BPG074M, BPG074P, BPG084M...(Other models you can see in the webshop)		



			
1			
<b>GEV No.</b>	690099	<b>Ref. No.</b>	50005090 58002150 LA58002150 LAR50005090 LAR58002150
<b>description</b>	hinge pin mounting pos. upper for door		
<b>For models:</b>	ABE044M, ABE054M, ABE084S, ABE104S, ABE156X, ABG064M, ABG074M, ABG084X, ABG104X, ABG156S, ACE10M, ACG10M, AME07D, AME07P, AME10D, APE06, APE07, APG08M, APG10M, AREN154, ARES154, ARGN154, ARG154, AVE07D, AVE07P, AVE10D, AVE10P, AVG10D, AVG20D, BPE064M, BPE064P, BPE074M, BPE074P, BPE084M, BPE084P, BPE104M, BPE104P, BPG064M, BPG064P, BPG074M, BPG074P, BPG084M, BPG084P, BPG104M, BPG104P, CE071M, CE100M, CE106M, CE110M, CE200M...(Other models you can see in the webshop)		

			
1			
<b>GEV No.</b>	690593	<b>Ref. No.</b>	58002570 LA58002570 LAR58002570
<b>description</b>	plain washer ID ø 15mm ED ø 30mm thickness 3mm Qty 1 pcs for door hinge		
<b>For models:</b>	ABE156X, ABG156S, AREN154, ARES154, ARGN154, ARG154, CEC40M, CES24M, CES40M, CGC24M, CGC40M, CGS24M, CGS40M, EMT21P, EPE156T, EPEV15T, EPG156T, EPGV15T, FME201SX, GEMT21P, GEMT21S, GEMT21T, GEMT21X, GEMT40P, GEMT40S, GEMT40T, GEMT40X, GEVT21P, GEVT21S, GEVT21T, GEVT21X, GEVT40P, GEVT40S, GEVT40T, GEVT40X, GGMT21P, GGMT21S, GGMT21T, GGMT21X, GGMT40P, GGMT40S, GGMT40T, GGMT40X, GGVT21P, GGVT21S, GGVT21T, GGVT21X, GGVT40P, GGVT40S, GGVT40T...(Other models you can see in the webshop)		

accessories

miscellaneous

			
1			
<b>GEV No.</b>	690595	<b>Ref. No.</b>	58002550 LA58002550 LAR58002550
<b>description</b>	bush for door hinge		
<b>For models:</b>	ABE156X, ABG156S, AREN154, ARES154, ARGN154, ARG154, CEC40M, CES24M, CES40M, CGC24M, CGC40M, CGS24M, CGS40M, EMT21P, EPE156T, EPEV15T, EPG156T, EPGV15T, FME201SX, GEMT21P, GEMT21S, GEMT21T, GEMT21X, GEMT40P, GEMT40S, GEMT40T, GEMT40X, GEVT21P, GEVT21S, GEVT21T, GEVT21X, GEVT40P, GEVT40S, GEVT40T, GEVT40X, GGMT21P, GGMT21S, GGMT21T, GGMT21X, GGMT40P, GGMT40S, GGMT40T, GGMT40X, GGVT21P, GGVT21S, GGVT21T, GGVT21X, GGVT40P, GGVT40S, GGVT40T...(Other models you can see in the webshop)		

			
1			
<b>GEV No.</b>	690594	<b>Ref. No.</b>	58002560 LA58002560 LAR58002560
<b>description</b>	pressure screw for door hinge		
<b>For models:</b>	ABE156X, ABG156S, AREN154, ARES154, ARGN154, ARG154, CEC40M, CES24M, CES40M, CGC24M, CGC40M, CGS24M, CGS40M, EMT21P, EPE156T, EPEV15T, EPG156T, EPGV15T, FME201SX, GEMT21P, GEMT21S, GEMT21T, GEMT21X, GEMT40P, GEMT40S, GEMT40T, GEMT40X, GEVT21P, GEVT21S, GEVT21T, GEVT21X, GEVT40P, GEVT40S, GEVT40T, GEVT40X, GGMT21P, GGMT21S, GGMT21T, GGMT21X, GGMT40P, GGMT40S, GGMT40T, GGMT40X, GGVT21P, GGVT21S, GGVT21T, GGVT21X, GGVT40P, GGVT40S, GGVT40T...(Other models you can see in the webshop)		

			
1			
<b>GEV No.</b>	690592	<b>Ref. No.</b>	58002540 LAR58002540
<b>description</b>	pin for hinge		
<b>For models:</b>	ABE156X, ABG156S, AREN154, ARES154, ARGN154, ARG154, CEC40M, CES24M, CES40M, CGC24M, CGC40M, CGS24M, CGS40M, EMT21P, EPE156T, EPEV15T, EPG156T, EPGV15T, FME201SX, GEMT21P, GEMT21S, GEMT21T, GEMT21X, GEMT40P, GEMT40S, GEMT40T, GEMT40X, GEVT21P, GEVT21S, GEVT21T, GEVT21X, GEVT40P, GEVT40S, GEVT40T, GEVT40X, GGMT21P, GGMT21S, GGMT21T, GGMT21X, GGMT40P, GGMT40S, GGMT40T, GGMT40X, GGVT21P, GGVT21S, GGVT21T, GGVT21X, GGVT40P, GGVT40S, GGVT40T...(Other models you can see in the webshop)		

<p>TENTE</p> <p>with fixing plate</p> <p>stainless steel</p>			
			
1			
<b>GEV No.</b>	701624	<b>Ref. No.</b>	69090100 LA69090100 LAR69090100
<b>description</b>	swivel castor with swivel brake ø 125mm plate fixing housing stainless steel plate size 105x85mm hole distance 78x60mm capacity 200kg bearing slide bearing wheel body polyamide tread polyurethane H 155mm wheel width 32mm		
<b>For models:</b>	ABE156X, ABG156S, EMT21P, EPE156T, EPEV15T, EPG156T, EPGV15T, GEMT21P, GEMT21T, GEMT21X, GEMT40P, GEMT40S, GEMT40T, GEVT40P, GEVT40T, GGMT21P, GGMT21T, GGMT40P, GGMT40T, GGVT21P, GGVT21T, GGVT40P, GGVT40T, GSE201N, HME201P, HME201S, HME201T, HME201X, HME202P, HME202S, HME202T, HME202X, HMG201P, HMG201T, HMG201X, HMG202P, HMG202T, HMG202X, HVE201P, HVE201S, HVE201T, HVE201X, HVE202P, HVE202T, HVE202X, HVG201P, HVG201T, HVG201X, HVG202P, HVG202T...(Other models you can see in the webshop)		

mechanical components, equipment accessories





1

<b>GEV No.</b>	701622	<b>Ref. No.</b>	69090090 LA69090090 LAR69090090
<b>description</b>	swivel castor without brake ø 125mm plate fixing housing stainless steel plate size 105x85mm hole distance 78x60mm capacity 200kg bearing slide bearing wheel body polyamide tread polyurethane H 155mm wheel width 32mm		
<b>For models:</b>	ABE156X, ABG156S, EMT21P, EPE156T, EPEV15T, EPG156T, EPGV15T, GEMT21P, GEMT21T, GEMT40P, GEMT40T, GEVT21P, GEVT21T, GEVT40P, GEVT40T, GGMT21P, GGMT21T, GGMT40P, GGMT40T, GGVT21P, GGVT21T, GGVT40P, GGVT40T, GSE201N, HME201P, HME201S, HME201T, HME201X, HME202P, HME202S, HME202T, HME202X, HMG201P, HMG201T, HMG201X, HMG202P, HMG202T, HMG202X, HVE201P, HVE201S, HVE201T, HVE201X, HVE202P, HVE202T, HVE202X, HVG201P, HVG201T, HVG201X, HVG202P, HVG202T... (Other models you can see in the webshop)		

## shelf rails and supports

### producer-specific



1

<b>GEV No.</b>	701628	<b>Ref. No.</b>	58001850 LA58001850 LAR58001850
<b>description</b>	bolt for setting bar L 21mm thread ø M5mm		
<b>For models:</b>	CBEN061, CBES061, CEV026S, CEV026X, CEV061S, CEV061X, CEV101S, CEV101X, CME061S, CME061X, COEN026, COEN061, COEN101, COES026, COES061, COES101, CVE024S, CVE024X, CVE061S, CVE061X, CVEN061, CVES061, CVG061S, CVG061X, CVGN061, CVGS061, KME061S, KME061X, KME081S, KME081X, KME101S, KME101X, KMEA20S, KMEA20X, KMG081S, KMG081X, KMG101S, KMG101X, KMG20S, KMG20X, KVE061S, KVE061X, KVE081S, KVE081X, KVE101S, KVE101X, KVEA20S, KVEA20X, KVG061X, KVG081S... (Other models you can see in the webshop)		

## shelves and shelf rails

### grates

#### universal

#### without upstand



1

<b>GEV No.</b>	970122	<b>Ref. No.</b>	FR6350610 FR990039 X1100
<b>description</b>	grate W 325mm D 530mm GN 1/1 H 8mm stainless steel wire gauge frame 7mm lengthwise wires gauge 4mm crossing wires 1		
<b>accessories for</b>	970122		
<b>GEV No.</b>	690330	<b>Ref. No.</b>	—
<b>description</b>	rack L 1000mm W 22mm H 4mm aperture 3x8mm hole distance 12.5mm stainless steel		
<b>GEV No.</b>	694700	<b>Ref. No.</b>	—
<b>description</b>	shelf support L 31/28mm W 22mm H 18mm SS Qty 12 pcs		
<b>GEV No.</b>	694701	<b>Ref. No.</b>	—
<b>description</b>	shelf support L 31/28mm W 22mm H 17mm SS with hook Qty 12 pcs		

## gaskets

### gaskets for heated units

#### window seals

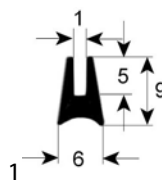

<b>GEV No.</b>	900787	<b>Ref. No.</b>	70044650 80100010 LAR70044650 LAR80100010
<b>description</b>	window gasket profile 1515 L 2200mm suitable for LAINOX		
<b>For models:</b>	AME07D, AME07P, APE06, APE07, AVE07D, AVE07P, BPE064M, BPE064P, BPE074M, BPE074P, BPG064M, BPG064P, BPG074M, BPG074P, CE071M, CG071M, MACE07M, MACG07M, MCE071M, MCG071M, MME071P, MMG071P, MVE071M, MVE071P, MVG071P, PE064M, PE064P, PE074M, PE074P, SIE071P, XAME07D		

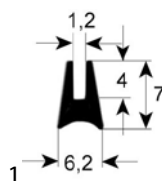

<b>GEV No.</b>	900440	<b>Ref. No.</b>	7070167
<b>description</b>	window gasket profile 1520 Qty supplied by meter		
<b>For models:</b>	VE102MX		

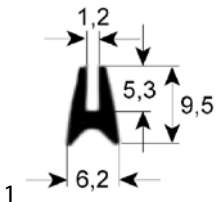
<b>GEV No.</b>	900129	<b>Ref. No.</b>	70040840 70040890 LAR70040840 LAR70040890
<b>description</b>	window gasket profile 1530 L 1015mm Qty 1		
<b>For models:</b>	CE110M, CE210M, CG110M, CG210M, FEI102P, FME101AX, ME110D, ME110H, ME110L, ME110M, ME110P, ME110S, ME110T, ME110X, ME210D, ME210H, ME210L, ME210M, ME210P, ME210S, ME210T, ME210X, MG110D, MG110H, MG110L, MG110M, MG110P, MG110S, MG110T, MG110X, MG210D, MG210H, MG210L, MG210M, MG210P, MG210S, MG210T, MG210X, PE005D, PE005K, PE005M, PE105D, PE105K, PE105M, PE105T, PE115K, PG005D, PG005K, PG005M, PG105D...(Other models you can see in the webshop)		

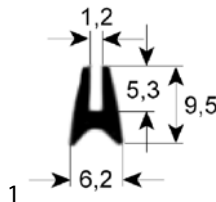

<b>GEV No.</b>	900503	<b>Ref. No.</b>	70044280 LAR70044280
<b>description</b>	window gasket profile 1530 L 1800mm Qty 1		
<b>For models:</b>	ABE156X, ABG156S, EPE156T, EPEV15T, EPG156T, EPGV15T, GSE201N, HME201P, HME201T, HME201X, HMG201P, HMG201T, HMG201X, HVE201P, HVE201T, HVE201X, HVG201P, HVG201T, HVG201X, MCE201M, MCG201M, ME201D, ME201H, ME201M, ME201P, ME201T, MG201D, MG201H, MG201M, MG201P, MG201T, PE156T, SCE201M, VE201D, VE201M, VE201P, VG201D, VG201M, VG201P		

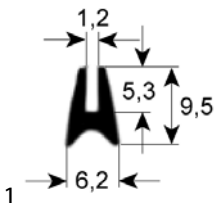

<b>GEV No.</b>	900501	<b>Ref. No.</b>	70044260 LAR70044260
<b>description</b>	window gasket profile 1530 L 1200mm Qty 1		
<b>For models:</b>	ABE084S, ABE104S, ABG064M, ABG074M, ABG084X, ABG104X, ACE10M, ACG10M, AME10D, APG08M, APG10M, AVE10D, AVE10P, AVG10D, AVG20D, BPE084M, BPE084P, BPE104M, BPE104P, BPG084M, BPG084P, BPG104M, BPG104P, CE100M, CE200M, CG100M, CG200M, EPE086T, EPEV08T, EPG086T, EPGV08T, EVEA20S, HME101P, HME101S, HME101T, HME101X, HME201S, HME202S, HMG101P, HMG101T, HMG101X, HVE101P, HVE101S, HVE101T, HVE101X, HVE102S, HVE201S, HVG101P, HVG101T, HVG101X...(Other models you can see in the webshop)		

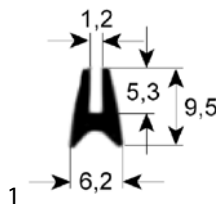

<b>GEV No.</b>	900504	<b>Ref. No.</b>	70044290 LAR70044290
<b>description</b>	window gasket profile 1530 L 1950mm Qty 1		
<b>For models:</b>	EMT21P, GEMT40P, GEMT40T, GEVT40P, GEVT40T, GGMT40P, GGMT40T, GGVT40P, GGVT40T, HME202P, HME202T, HME202X, HMG202P, HMG202T, HMG202X, HVE202P, HVE202T, HVE202X, HVG202P, HVG202T, HVG202X, MCE202M, MCG202M, ME202D, ME202H, ME202M, ME202P, ME202T, MEMT21D, MEMT21P, MEMT40D, MEMT40P, MEVT21D, MEVT21P, MEVT40D, MEVT40P, MG202D, MG202H, MG202M, MG202P, MG202T, MGMT21D, MGMT21P, MGMT40D, MGMT40P, MGVT21D, MGVT21P, MGVT40D, MGVT40P, VE202D...(Other models you can see in the webshop)		

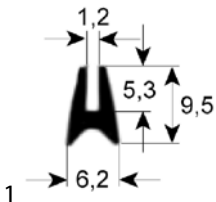

<b>GEV No.</b>	900130	<b>Ref. No.</b>	70040850 70040900 LAR70040850 LAR70040900
<b>description</b>	window gasket profile 1530 L 1750mm Qty 1		
<b>For models:</b>	CEC40M, CES40M, CGC40M, CGS40M, FME201SX, FMG201A, FMG201S, ME120D, ME120H, ME120L, ME120M, ME120P, ME120S, ME120T, ME120X, ME220D, ME220H, ME220L, ME220M, ME220P, ME220S, ME220T, ME220X, MEC20H, MEC20P, MEC20X, MEC40H, MEC40M, MEC40P, MED40D, MEK21H, MES20D, MES20H, MES20M, MES20P, MES20X, MES40D, MES40H, MES40M, MES40P, MES40X, MG120D, MG120H, MG120L, MG120M, MG120P, MG120S, MG120T, MG120X, MG220D...(Other models you can see in the webshop)		

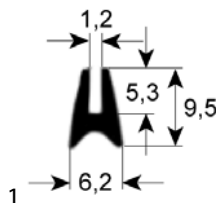

<b>GEV No.</b>	900483	<b>Ref. No.</b>	70044150 LAR70044150
<b>description</b>	window gasket profile 1530 L 2400mm Qty 1		
<b>For models:</b>	ACE10M, ACG10M, AME10D, APG08M, APG10M, AVE10D, AVE10P, AVG10D, AVG20D, BPE084M, BPE084P, BPE104M, BPE104P, BPG084M, BPG084P, BPG104M, BPG104P, CE100M, CE200M, CG100M, CG200M, EMT20P, EPE086T, EPEV08T, EPG086T, EPGV08T, EVT20D, GEMT20P, GEMT20T, GEVT20P, GEVT20T, GEVT20X, GGMT20P, GGMT20T, GGVT20P, GGVT20T, GMT20D, GMT20P, GVT20D, HME061P, HME061T, HME061X, HME101P, HME101S, HME101T, HME101X, HME102P, HME102S, HME102T, HME102X...(Other models you can see in the webshop)		

mechanical components, equipment accessories

<b>GEV No.</b>	900484	<b>Ref. No.</b>	70044160 LAR70044160
<b>description</b>	window gasket profile 1530 L 3720mm Qty 1		
<b>For models:</b>	ABE156X, ABG156S, EPE156T, EPEV15T, EPG156T, EPGV15T, GEMT40P, GEMT40T, GEVT40P, GEVT40T, GGMT40P, GGMT40T, GGVT40P, GGVT40T, GSE201N, HME201P, HME201S, HME201T, HME201X, HME202P, HME202S, HME202T, HME202X, HMG201P, HMG201T, HMG201X, HMG202P, HMG202T, HMG202X, HVE201P, HVE201S, HVE201T, HVE201X, HVE202P, HVE202T, HVE202X, HVG201P, HVG201T, HVG201X, HVG202P, HVG202T, HVG202X, MCE201M, MCE202M, MCG201M, MCG202M, ME201D, ME201H, ME201M, ME201P...(Other models you can see in the webshop)		

<b>GEV No.</b>	900500	<b>Ref. No.</b>	70044250 LAR70044250
<b>description</b>	window gasket profile 1530 L 900mm Qty 1		
<b>For models:</b>	ABE044M, ABE054M, AME07D, AME07P, APE06, APE07, AVE07D, AVE07P, AVG05P, BPE044M, BPE044P, BPE054M, BPE054P, BPE064M, BPE064P, BPE074M, BPE074P, BPG044M, BPG044P, BPG054M, BPG054P, BPG064M, BPG064P, BPG074M, BPG074P, CE071M, CG071M, EPE056T, EPEV05T, EPG056T, EPGV05T, GEMT06P, GEMT06T, GEVT06P, GEVT06S, GEVT06T, GGMT06P, GGMT06T, GGVT06P, GGVT06T, HME061P, HME061T, HME061X, HMG061P, HMG061T, HMG061X, HVE061P, HVE061T, HVE061X, HVE102P...(Other models you can see in the webshop)		

<b>GEV No.</b>	900117	<b>Ref. No.</b>	70040810 LAR70040810
<b>description</b>	window gasket profile 1530 L 505mm Qty 1		
<b>For models:</b>	CVE004H, CVE004M, CVE104H, CVE104M, ME004L, ME004S, ME104L, ME104S, VE004D, VE004H, VE004M, VE004S, VE004X, VE104D, VE104H, VE104M, VE104S, VE104X		

<b>GEV No.</b>	900143	<b>Ref. No.</b>	80100100 LAR80100100
<b>description</b>	window gasket profile 1530 Qty supplied by meter		
<b>For models:</b>	AREN064, AREN084, AREN154, ARES064, ARES084, ARES154, ARGN064, ARGN084, ARGN154, ARGS064, ARGS084, ARGS154, CBEN061, CBES061, CKES10, CME061S, CME061X, CVE024S, CVE024X, CVE061S, CVE061X, CVEN061, CVES061, CVG061S, CVG061X, CVGN061, CVGS061, GEMT07S, GEMT07X, GEMT10S, GEMT10X, GEMT20S, GEMT20X, GEMT21S, GEMT21X, GEMT40S, GEMT40X, GEVT07S, GEVT07X, GEVT10S, GEVT10X, GEVT20S, GEVT20X, GEVT21S, GEVT21X, GEVT40S, GEVT40X, GGMT07S, GGMT07X, GGMT10S...(Other models you can see in the webshop)		

<b>GEV No.</b>	900118	<b>Ref. No.</b>	70040820 LAR70040820
<b>description</b>	window gasket profile 1530 L 595mm Qty 1		
<b>For models:</b>	CG105M, CVE105H, CVE105M, CVG105H, CVG105M, ME105L, ME105S, MG105L, MG105S, VE105D, VE105H, VE105M, VE105NS, VE105S, VE105X, VE155H, VE155M, VE155X, VG105D, VG105H, VG105M, VG105S, VG105X		

<b>GEV No.</b>	900637	<b>Ref. No.</b>	70040640 70040650 LAR70040640 LAR70040650 LAR70040730 LAR70040740 LAR80100100
<b>description</b>	window gasket profile 1530 Qty supplied by meter		
<b>For models:</b>	EMT10D, EVT10P, FE110M, FE110X, FE210M, FE210X, FG110M, FG110X, FG210M, FG210X, GEMT10P, GEMT10T, GEVT10P, GEVT10T, GGMT10P, GGMT10T, GGVT10P, GGVT10T, ME110L, ME110S, ME110T, ME110X, ME210L, ME210S, ME210T, ME227M, ME227P, ME227X, MEMT10D, MEMT10P, MEVT10D, MEVT10P, MG110L, MG110M, MG110P, MG110S, MG110T, MG110X, MG210L, MG210M, MG210P, MG210S, MG210T, MG210X, MG227M, MG227P, MG227X, MGMT10D, MGMT10P, MGVT10D...(Other models you can see in the webshop)		

<b>GEV No.</b>	900128	<b>Ref. No.</b>	70040830 70040880 LAR70040830 LAR70040880
<b>description</b>	window gasket profile 1530 L 750mm Qty 1		
<b>For models:</b>	CE106M, CG106M, FME61A, FME61S, ME106D, ME106H, ME106L, ME106M, ME106P, ME106S, ME106T, ME106X, MG106D, MG106H, MG106L, MG106M, MG106P, MG106S, MG106T, MG106X, VE106D, VE106H, VE106L, VE106M, VE106P, VE106S, VE106T, VE106X, VG106D, VG106H, VG106L, VG106M, VG106P, VG106S, VG106T, VG106X		



<b>GEV No.</b>	900120	<b>Ref. No.</b>	70040050 70040060 LAR70040050 LAR70040060
<b>description</b>	window gasket profile 1620 L 1175mm Qty 1		
<b>For models:</b>	CVE004H, CVE004M, CVE104H, CVE104M, ME004L, ME004S, ME104L, ME104S, VE004D, VE004H, VE004M, VE004S, VE004X, VE104D, VE104H, VE104M, VE104S, VE104X		

<b>GEV No.</b>	900122	<b>Ref. No.</b>	50505825 70040200 LAR50505825 LAR70040200
<b>description</b>	window gasket profile 1620 L 2125mm Qty 1		
<b>For models:</b>	CE110M, CE210M, CEC40M, CES24M, CES40M, CG110M, CG210M, CGC24M, CGC40M, CGS24M, CGS40M, FEI102P, FME101AX, FME201SX, FMG201A, FMG201S, ME110D, ME110H, ME110M, ME110P, ME110X, ME120D, ME120H, ME120L, ME120M, ME120P, ME120S, ME120T, ME120X, ME21, ME210D, ME210H, ME210M, ME210P, ME210X, ME220D, ME220H, ME220L, ME220M, ME220P, ME220S, ME220T, ME220X, ME40, MEC20H, MEC20P, MEC20X, MEC24H, MEC40H, MEC40M...(Other models you can see in the webshop)		

<b>GEV No.</b>	900119	<b>Ref. No.</b>	50505821 70040010 70040020 LAR50505821 LAR70040010 LAR70040020
<b>description</b>	window gasket profile 1620 L 1500mm Qty 1		
<b>For models:</b>	CG105M, CVE105H, CVE105M, CVG105H, CVG105M, FE05, FE051M, FE051X, FG05, FG051M, FG051X, ME05, ME105L, ME105S, MG05, MG105L, MG105S, MME05, PE04, PE041M, PE041X, PE051M, PE051X, PG04, PG041M, PG041X, PG051M, PG051X, RE05, RG05, VE105D, VE105H, VE105M, VE105NS, VE105S, VE105X, VE155H, VE155M, VE155X, VG105D, VG105H, VG105M, VG105S, VG105X		

<b>GEV No.</b>	900481	<b>Ref. No.</b>	50505823 70040120 70040130 70040210 70040690 LAR50505823 LAR70040120 LAR70040130 LAR70040210 LAR70040690
<b>description</b>	window gasket profile 1620 L 2400mm Qty 1		
<b>For models:</b>	FE101M, FE101X, FE102M, FE102X, FG101M, FG101X, FG102M, FG102X, ME10, ME120P, ME20, ME24, MG10, MG120M, MG120P, MG120X, MG20, MG220M, MG220P, MG220X, MG24, MME10, PE081M, PE081X, PE101M, PE101X, PG08, PG081M, PG081X, PG101M, PG101X, RE10, RE20, RE24, RG10, RG20, RG24		

<b>GEV No.</b>	900121	<b>Ref. No.</b>	50505822 70040080 LAR50505822 LAR70040080
<b>description</b>	window gasket profile 1620 L 1690mm Qty 1		
<b>For models:</b>	CE106M, CG106M, FME61A, FME61S, ME106D, ME106H, ME106M, ME106P, ME106X, MG106D, MG106H, MG106M, MG106P, MG106X, RE07, RG07, VE106D, VE106H, VE106L, VE106M, VE106P, VE106S, VE106T, VE106X, VG106D, VG106H, VG106L, VG106M, VG106P, VG106S, VG106T, VG106X		

<b>GEV No.</b>	900058	<b>Ref. No.</b>	R70040010-25MT R70040010-6MT R70040120-25MT R70040120-6MT R70040200-25MT R70040200-6MT R80100010-25MT R80100010-6MT
<b>description</b>	window gasket profile 1620 Qty supplied by meter		

<b>GEV No.</b>	900482	<b>Ref. No.</b>	50505824 70040160 LAR50505824 LAR70040160
<b>description</b>	window gasket profile 1620 L 1800mm Qty 1		
<b>For models:</b>	ME15, MG15, PE12, PG12		

mechanical components, equipment accessories

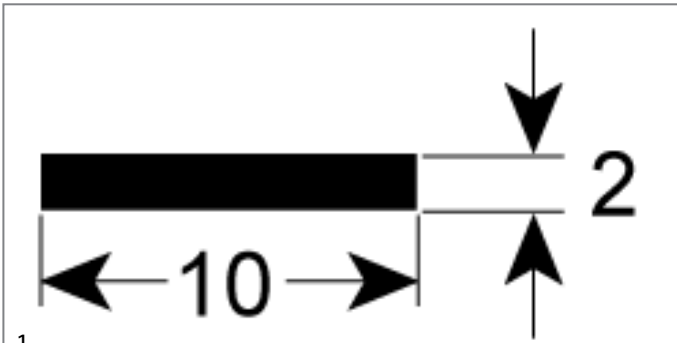

<b>GEV No.</b>	902460	<b>Ref. No.</b>	70042680 LAR70042680
<b>description</b>	window gasket profile 1887 L 3200mm Qty 1 suitable for LAINOX		
<b>For models:</b>	EC020M, EC210M, EM020M, EM210H, EM210M, EM210M+SC, EM210P, EV020M, EV210H, EV210M, EV210M+SC, EV210P, GC020M, GC210M, GM020H, GM020M, GM210H, GM210M, GM210M+SC, GM210P, GV020H, GV210H, GV210M, GV210M+SC, GV210P		



<b>GEV No.</b>	901361	<b>Ref. No.</b>	70042610 LAR70042610
<b>description</b>	window gasket profile 1887 L 6500mm suitable for LAINOX		
<b>For models:</b>	PE008D, PE008K, PE008M, PE108D, PE108K, PE108M, PE108T, PG008D, PG008K, PG008M, PG108D, PG108K, PG108M, PG108T		



<b>GEV No.</b>	900935	<b>Ref. No.</b>	70042630 LAR70042630
<b>description</b>	window gasket profile 1887 L 8900mm front		
<b>For models:</b>	PE015D, PE015K, PE015M, PE115D, PE115K, PE115M, PE115T, PG015M, PG115M		

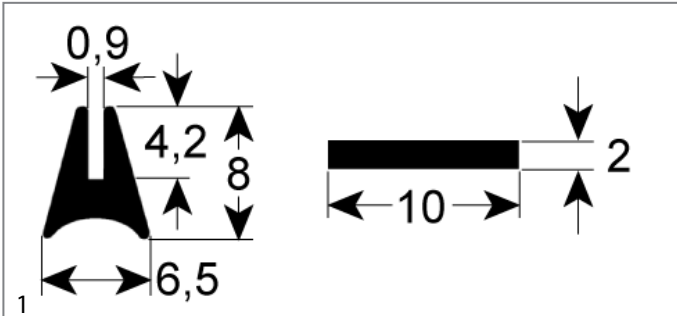

<b>GEV No.</b>	902459	<b>Ref. No.</b>	70042770 70042780 LAR70042770 LAR70042780
<b>description</b>	window gasket profile 1887/1515 L 2200mm suitable for LAINOX set 2-piece		
<b>For models:</b>	EC020M, EC110M, EC210M, EM010H, EM010M+SC, EM020M, EM110H, EM110M, EM110M+SC, EM110P, EM210H, EM210M, EM210M+SC, EM210P, EV010H, EV010M, EV010P, EV020M, EV110H, EV110M, EV110M+SC, EV110P, EV210H, EV210M, EV210M+SC, EV210P, GC010M, GC020M, GC110M, GC210M, GM020H, GM020M, GM110H, GM110M, GM110M+SC, GM110P, GM210H, GM210M, GM210M+SC, GM210P, GV010H, GV010M, GV020H, GV110H, GV110M, GV110M+SC, GV110P, GV210H, GV210M, GV210M+SC...(Other models you can see in the webshop)		



<b>GEV No.</b>	901360	<b>Ref. No.</b>	70042710 LAR70042710
<b>description</b>	window gasket profile 1887/1515 L 2830mm set 2-piece suitable for LAINOX		
<b>For models:</b>	PE008D, PE008K, PE008M, PE108D, PE108K, PE108M, PE108T, PG008D, PG008K, PG008M, PG108D, PG108K, PG108M, PG108T		
<b>spare parts for</b>	901360		70040640 70040650 LAR70040640 LAR70040650 LAR70040730 LAR70040740 LAR80100100
	<b>GEV No.</b>	900637	<b>Ref. No.</b>
			R70040640 R70040650 R70040730 R70040740
	window gasket profile 1530 Qty supplied by meter		

door seals



<b>GEV No.</b>	902461	<b>Ref. No.</b>	70042860 LAR70042860
<b>description</b>	door seal profile 2010 L 1900mm Qty 1 suitable for LAINOX		
<b>For models:</b>	EC106M, EM006H, EM006M+SC, EM106H, EM106M, EM106M+SC, EM106P, EV006M, EV006P, EV106H, EV106M, EV106M+SC, EV106P, GC106M, GM106H, GM106M, GM106M+SC, GM106P, GV006H, GV006M, GV106H, GV106M, GV106M+SC, GV106P		



<b>GEV No.</b>	901147	<b>Ref. No.</b>	70042880 LAR70042880
<b>description</b>	door seal profile 2010 L 3000mm Qty 1		
<b>For models:</b>	EC020M, EC210M, EM020M, EM210H, EM210M, EM210M+SC, EM210P, EV020M, EV210H, EV210M, EV210M+SC, EV210P, GC020M, GC210M, GM020H, GM020M, GM210H, GM210M, GM210M+SC, GM210P, GV020H, GV210H, GV210M, GV210M+SC, GV210P		





<b>GEV No.</b>	900142	<b>Ref. No.</b>	70042830 70043250 70043280 70043290 80100070 LAR70042830 LAR70043250 LAR70043280 LAR70043290 LAR80100070
<b>description</b>	door seal profile 2010 Qty supplied by meter		
<b>For models:</b>	CE106M, CES24M, CG106M, CGC24M, CGS24M, ME106D, ME106H, ME106M, ME106P, ME106X, MEC20H, MEC20P, MEC20X, MEC24H, MEK21H, MES20D, MES20H, MES20M, MES20P, MES20X, MES24D, MES24H, MES24M, MES24P, MES24X, MG106D, MG106H, MG106M, MG106P, MG106X, MGC20H, MGC20X, MGC24H, MGS20D, MGS20H, MGS20M, MGS20P, MGS20X, MGS24D, MGS24H, MGS24M, MGS24P, MGS24X, PE015D, PE015K, PE015M, PE115D, PE115K, PE115M, PE115T...(Other models you can see in the webshop)		

<b>GEV No.</b>	900135	<b>Ref. No.</b>	70041020 LAR70041020
<b>description</b>	door seal profile 2010 W 700mm L 1410mm external size Qty 1		
<b>For models:</b>	ME220D, ME220H, ME220L, ME220M, ME220P, ME220S, ME220T, ME220X, MG220D, MG220H, MG220L, MG220M, MG220P, MG220S, MG220T, MG220X, VE220D, VE220H, VE220M, VE220P, VE220X, VG220D, VG220H, VG220M, VG220P, VG220X		

<b>GEV No.</b>	900131	<b>Ref. No.</b>	70040980 LAR70040980
<b>description</b>	door seal profile 2010 W 520mm L 610mm external size Qty 1		
<b>For models:</b>	FME61A, FME61S, ME106D, ME106H, ME106L, ME106M, ME106P, ME106S, ME106T, ME106X, MG106D, MG106H, MG106L, MG106M, MG106P, MG106S, MG106T, MG106X, VE106D, VE106H, VE106L, VE106M, VE106P, VE106S, VE106T, VE106X, VG106D, VG106H, VG106L, VG106M, VG106P, VG106S, VG106T, VG106X		

<b>GEV No.</b>	900133	<b>Ref. No.</b>	70041000 LAR70041000
<b>description</b>	door seal profile 2010 W 740mm L 765mm external size Qty 1		
<b>For models:</b>	ME210D, ME210H, ME210L, ME210M, ME210P, ME210S, ME210T, ME210X, MG210D, MG210H, MG210L, MG210M, MG210P, MG210S, MG210T, MG210X, VE210D, VE210H, VE210L, VE210M, VE210P, VE210S, VE210T, VE210X, VG210D, VG210H, VG210L, VG210M, VG210P, VG210S, VG210T, VG210X		

<b>GEV No.</b>	900132	<b>Ref. No.</b>	70040990 70043260 LAR70040990 LAR70043260
<b>description</b>	door seal profile 2010 W 625mm L 750mm external size Qty 1		
<b>For models:</b>	CE110M, CG110M, FME101AX, ME110D, ME110H, ME110L, ME110M, ME110P, ME110S, ME110T, ME110X, MG110D, MG110H, MG110L, MG110M, MG110P, MG110S, MG110T, MG110X, VE110D, VE110H, VE110L, VE110M, VE110P, VE110S, VE110T, VE110X, VG110D, VG110H, VG110L, VG110M, VG110P, VG110S, VG110T, VG110X		

<b>GEV No.</b>	900348	<b>Ref. No.</b>	R70041200-15MT R70041200-6MT R70041250-15MT R70041250-6MT R70041290-15MT R70041290-6MT R70041330-6MT R70041540_3MT R70041540-15MT R70041540-6MT R70041560-15MT R70041560-6MT R70041780-15MT R70041780-6MT R70042510-15MT R70042510-6MT R80100490-15MT R80100490-6MT
<b>description</b>	door seal profile 2402 Qty supplied by meter		

<b>GEV No.</b>	900134	<b>Ref. No.</b>	70041010 LAR70041010
<b>description</b>	door seal profile 2010 W 680mm L 1425mm external size Qty 1		
<b>For models:</b>	FME201SX, FMG201A, FMG201S, ME120D, ME120H, ME120L, ME120M, ME120P, ME120S, ME120T, ME120X, MG120D, MG120H, MG120L, MG120M, MG120P, MG120S, MG120T, MG120X, VE120D, VE120H, VE120L, VE120M, VE120P, VE120S, VE120X, VG120D, VG120H, VG120L, VG120M, VG120P, VG120X		

mechanical components, equipment accessories

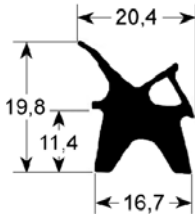

<b>GEV No.</b>	900059	<b>Ref. No.</b>	80100490 LA80100491 LAR80100490
<b>description</b>	door seal profile 2410 Qty supplied by meter		

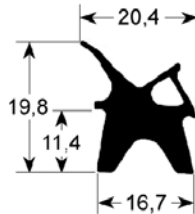

<b>GEV No.</b>	900116	<b>Ref. No.</b>	70042000 70042080 LAR70042000 LAR70042080
<b>description</b>	door seal profile 2410 W 380mm L 608mm external size Qty 1		
<b>For models:</b>	CG105M, CVE105H, CVE105M, CVG105H, CVG105M, ME105L, ME105S, MG105L, MG105S, VE105D, VE105H, VE105M, VE105S, VE105X, VE155H, VE155M, VE155X, VG105D, VG105H, VG105M, VG105S, VG105X		

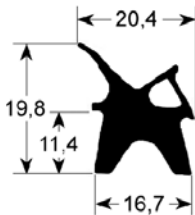

<b>GEV No.</b>	900115	<b>Ref. No.</b>	70041760 70041990 70042070 LAR70041760 LAR70041990 LAR70042070
<b>description</b>	door seal profile 2410 W 320mm L 420mm external size Qty 1		
<b>For models:</b>	CVE004H, CVE004M, CVE104H, CVE104M, ME004L, ME004S, ME104L, ME104S, VE004D, VE004H, VE004M, VE004S, VE004X, VE104D, VE104H, VE104M, VE104S, VE104X		

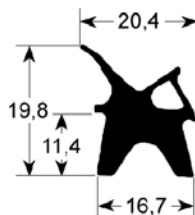

<b>GEV No.</b>	900157	<b>Ref. No.</b>	50505950 70041540 LAR50505950 LAR70041540
<b>description</b>	door seal profile 2410 W 380mm L 632mm external size Qty 1		
<b>For models:</b>	FE051M, FE051X, FE105M, FE105X, FG051M, FG051X, FG105M, FG105X, PE04, PE040M, PE040X, PE041M, PE041X, PE051M, PE051X, PG04, PG040M, PG040X, PG041M, PG041X, PG051M, PG051X		

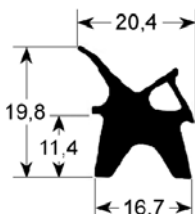

<b>GEV No.</b>	900136	<b>Ref. No.</b>	50505940 70041200 LA70041201 LAR50505940 LAR70041200
<b>description</b>	door seal profile 2410 W 345mm L 560mm external size Qty 1		
<b>For models:</b>	FE05, FG05		

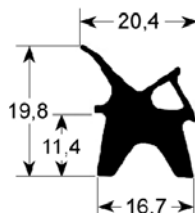

<b>GEV No.</b>	900158	<b>Ref. No.</b>	50505941 70041250 70041260 LAR50505941 LAR70041250 LAR70041260
<b>description</b>	door seal profile 2410 W 413mm L 608mm external size Qty 1		
<b>For models:</b>	ME05, MG05, MME05, RE05, RG05		

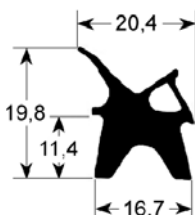

<b>GEV No.</b>	900138	<b>Ref. No.</b>	50505953 70041210 LAR50505953 LAR70041210
<b>description</b>	door seal profile 2410 W 353mm L 405mm external size Qty 1		
<b>For models:</b>	FV03		



<b>GEV No.</b>	900156	<b>Ref. No.</b>	50505954 70041220 LAR50505954 LAR70041220
<b>description</b>	door seal profile 2410 W 427mm L 726mm external size Qty 1		
<b>For models:</b>	FV06		

<b>GEV No.</b>	900123	<b>Ref. No.</b>	70042010 70042090 70043610 LAR70042011 LAR70042010 LAR70042090 LAR70043610
<b>description</b>	door seal profile 2410 W 500mm L 627mm external size Qty 1		
<b>For models:</b>	CE106M, CG106M, FME61A, FME61S, ME106D, ME106H, ME106L, ME106M, ME106P, ME106S, ME106T, ME106X, MG106D, MG106H, MG106L, MG106M, MG106P, MG106S, MG106T, MG106X, VE106D, VE106H, VE106L, VE106M, VE106P, VE106S, VE106T, VE106X, VG106D, VG106H, VG106L, VG106M, VG106P, VG106S, VG106T, VG106X		

<b>GEV No.</b>	900817	<b>Ref. No.</b>	70042560 LAR70042560 R70042561
<b>description</b>	door seal profile 2410 W 465mm L 495mm external size Qty 1		
<b>For models:</b>	EC106M, EM006H, EM006M+SC, EM106H, EM106M, EM106M+SC, EM106P, EV006M, EV006P, EV106H, EV106M, EV106M+SC, EV106P, GC106M, GM106H, GM106M, GM106M+SC, GM106P, GV006H, GV006M, GV106H, GV106M, GV106M+SC, GV106P		

<b>GEV No.</b>	900485	<b>Ref. No.</b>	50505942 70041270 LAR50505942 LAR70041270
<b>description</b>	door seal profile 2410 W 583mm L 647mm external size Qty 1		
<b>For models:</b>	RE07, RG07		

<b>GEV No.</b>	900818	<b>Ref. No.</b>	70042570 70042571 LAR70042570 LAR70042571
<b>description</b>	door seal profile 2410 W 465mm L 765mm external size Qty 1		
<b>For models:</b>	EC110M, EM010H, EM010M+SC, EM110H, EM110M, EM110M+SC, EM110P, EV010H, EV010M, EV010P, EV110H, EV110M, EV110M+SC, EV110P, GC010M, GC110M, GM110H, GM110M, GM110M+SC, GM110P, GV010H, GV010M, GV110H, GV110M, GV110M+SC, GV110P		

<b>GEV No.</b>	900816	<b>Ref. No.</b>	70042140 LAR70042140
<b>description</b>	door seal profile 2410 W 618mm L 777mm external size Qty 1		
<b>For models:</b>	ME227M, ME227P, ME227X, MG227M, MG227P, MG227X		

mechanical components, equipment accessories

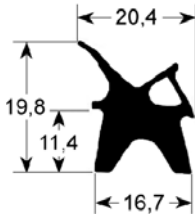
<b>GEV No.</b>	900124	<b>Ref. No.</b>	70042020 70042100 70043620 LA70042021 LAR70042020 LAR70042100 LAR70043620 R70042021
<b>description</b>	door seal profile 2410 W 627mm L 738mm external size Qty 1		
<b>For models:</b>	CE110M, CG110M, FME101AX, ME110D, ME110H, ME110L, ME110M, ME110P, ME110S, ME110T, ME110X, MG110D, MG110H, MG110L, MG110M, MG110P, MG110S, MG110T, MG110X, VE110D, VE110H, VE110L, VE110M, VE110P, VE110S, VE110T, VE110X, VEC20P, VG110D, VG110H, VG110L, VG110M, VG110P, VG110S, VG110T, VG110X		

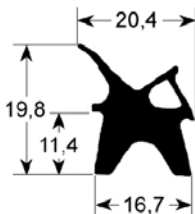

<b>GEV No.</b>	900820	<b>Ref. No.</b>	70042580 LAR70042580
<b>description</b>	door seal profile 2410 W 645mm L 765mm external size Qty 1		
<b>For models:</b>	EC020M, EC210M, EM020M, EM210H, EM210M, EM210M+SC, EM210P, EV020M, EV210H, EV210M, EV210M+SC, EV210P, GC020M, GC210M, GM020H, GM020M, GM210H, GM210M, GM210M+SC, GM210P, GV020H, GV210H, GV210M, GV210M+SC, GV210P		

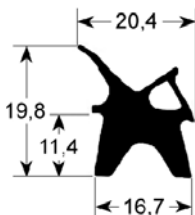

<b>GEV No.</b>	900159	<b>Ref. No.</b>	50505943 70041290 70041300 LAR50505943 LAR70041290 LAR70041300
<b>description</b>	door seal profile 2410 W 655mm L 755mm external size Qty 1		
<b>For models:</b>	ME10, MG10, MME10, RE10, RG10		

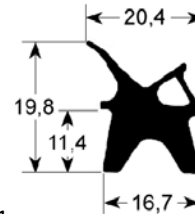

<b>GEV No.</b>	900486	<b>Ref. No.</b>	50505951 70041550 LAR50505951 LAR70041550
<b>description</b>	door seal profile 2410 W 666mm L 701mm external size Qty 1		
<b>For models:</b>	FE101M, FE101X, FE110M, FE110X, FG101M, FG101X, FG110M, FG110X, PE08, PE080M, PE080X, PE081M, PE081X, PE101M, PE101X, PG08, PG080M, PG080X, PG081M, PG081X, PG101M, PG101X		

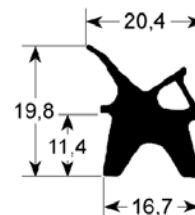

<b>GEV No.</b>	901260	<b>Ref. No.</b>	70042510 LAR70042510
<b>description</b>	door seal profile 2410 W 675mm L 775mm external size Qty 1 suitable for LAINOX		
<b>For models:</b>	PE008D, PE008K, PE008M, PE108D, PE108K, PE108M, PE108T, PG008D, PG008K, PG008M, PG108D, PG108K, PG108M, PG108T		

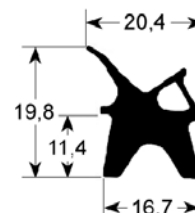

<b>GEV No.</b>	900762	<b>Ref. No.</b>	50505944 70041330 70041350 70041840 LAR50505944 LAR70041330 LAR70041350 LAR70041840
<b>description</b>	door seal profile 2410 W 701mm L 705mm external size Qty 1		
<b>For models:</b>	FE102M, FE102X, FE210M, FE210X, FG102M, FG102X, FG210M, FG210X, ME20, MG20, RE20, RG20		



1			
<b>GEV No.</b>	900165	<b>Ref. No.</b>	50505945 70041780 LAR50505945 LAR70041780
<b>description</b>	door seal profile 2410 W 710mm L 1195mm external size Qty 1		
<b>For models:</b>	ME15, MG15		

1			
<b>GEV No.</b>	900139	<b>Ref. No.</b>	50505946 70041370 LAR50505946 LAR70041370
<b>description</b>	door seal profile 2410 W 715mm L 880mm external size Qty 1		
<b>For models:</b>	ME24, MG24, RE24, RG24		

1			
<b>GEV No.</b>	900568	<b>Ref. No.</b>	70042150 LAR70042150
<b>description</b>	door seal profile 2410 W 710mm L 1310mm external size Qty 1		
<b>For models:</b>	MEC20H, MEC20P, MEC20X, MEK21H, MGC20H, MGC20X, VEC20M, VEC20X, VGC20H		

1			
<b>GEV No.</b>	900813	<b>Ref. No.</b>	70042160 LAR70042160
<b>description</b>	door seal profile 2410 W 735mm L 1310mm external size Qty 1		
<b>For models:</b>	CEC40M, CGC40M, MEC40H, MEC40M, MEC40P, MED40D, MGC40H, MGC40M, MGC40P, MGC40X, VEC40M, VEC40X		

1			
<b>GEV No.</b>	900126	<b>Ref. No.</b>	50505948 70041820 70042040 70042120 70042530 LAR50505948 LAR70041820 LAR70042040 LAR70042120 LAR70042530
<b>description</b>	door seal profile 2410 W 710mm L 1430mm external size Qty 1		
<b>For models:</b>	FME201SX, ME120D, ME120H, ME120L, ME120M, ME120P, ME120S, ME120T, ME120X, ME21, MES20D, MES20H, MES20M, MES20P, MES20X, MG120D, MG120H, MG120L, MG120M, MG120P, MG120S, MG120T, MG120X, MG21, MGS20D, MGS20H, MGS20M, MGS20P, MGS20X, PE015D, PE015K, PE015M, PE115D, PE115K, PE115M, PE115T, PG015D, PG015K, PG015M, PG115D, PG115K, PG115M, PG115T, VE120D, VE120H, VE120M, VE120P, VE120X, VES20D, VES20H... (Other models you can see in the webshop)		

1			
<b>GEV No.</b>	900127	<b>Ref. No.</b>	50505947 70041410 70041860 70042050 70042130 LAR50505947 LAR70041410 LAR70041860 LAR70042050 LAR70042130
<b>description</b>	door seal profile 2410 W 735mm L 1430mm external size Qty 1		
<b>For models:</b>	CES40M, CGS40M, ME220D, ME220H, ME220L, ME220M, ME220P, ME220S, ME220T, ME220X, ME40, MES40D, MES40H, MES40M, MES40P, MES40X, MG220D, MG220H, MG220L, MG220M, MG220P, MG220S, MG220T, MG220X, MG40, MGS40D, MGS40H, MGS40M, MGS40P, MGS40X, RG40, VE220D, VE220H, VE220M, VE220P, VE220X, VES40D, VES40H, VES40M, VES40P, VES40X, VG220D, VG220H, VG220M, VG220P, VG220X, VGS40D, VGS40H, VGS40M, VGS40P... (Other models you can see in the webshop)		

mechanical components, equipment accessories



<b>GEV No.</b>	900815	<b>Ref. No.</b>	70041940 LAR70041940
<b>description</b>	door seal profile 2410 W 735mm L 830mm external size Qty 1		
<b>For models:</b>	CGC24M, MEC24H, MGC24H, VGC24H		

<b>GEV No.</b>	900814	<b>Ref. No.</b>	70041930 LAR70041930
<b>description</b>	door seal profile 2410 W 735mm L 955mm external size Qty 1		
<b>For models:</b>	CES24M, CGS24M, MES24D, MES24H, MES24M, MES24P, MES24X, MGS24D, MGS24H, MGS24M, MGS24P, MGS24X, VES24D, VES24H, VES24M, VES24P, VES24X, VGS24D, VGS24H, VGS24M, VGS24P, VGS24X		

<b>GEV No.</b>	900125	<b>Ref. No.</b>	70042030 70042110 LAR70042030 LAR70042110
<b>description</b>	door seal profile 2410 W 738mm L 777mm external size Qty 1		
<b>For models:</b>	CE210M, CG210M, FEI102P, ME210D, ME210H, ME210L, ME210M, ME210P, ME210S, ME210T, ME210X, MG210D, MG210H, MG210L, MG210M, MG210P, MG210S, MG210T, MG210X, VE210D, VE210H, VE210L, VE210M, VE210P, VE210S, VE210T, VE210X, VG210D, VG210H, VG210L, VG210M, VG210P, VG210S, VG210T, VG210X		

<b>GEV No.</b>	900487	<b>Ref. No.</b>	50505952 70041560 LAR50505952 LAR70041560
<b>description</b>	door seal profile 2410 W 765mm L 1195mm external size Qty 1		
<b>For models:</b>	PE12, PG12		

<b>GEV No.</b>	901447	<b>Ref. No.</b>	70044510 A23203290 LAR70044510
<b>description</b>	door seal profile 2452 L 2900mm		

<b>GEV No.</b>	901444	<b>Ref. No.</b>	70044520 A32100810 LAR70044520
<b>description</b>	door seal profile 2452 Qty 3300mm		

<b>GEV No.</b>	900439	<b>Ref. No.</b>	7070166
<b>description</b>	door seal profile 2750 Qty supplied by meter		
<b>For models:</b>	VE102MX		

<b>GEV No.</b>	902023	<b>Ref. No.</b>	70048010 70048012 LA70048010 LAR70048012 LAR70048010 LAR70048012
<b>description</b>	door seal profile 2761 W 46mm L 775mm external size Qty 1 suitable for LAINOX		
<b>For models:</b>	AREN084, ARES084, ARGN084, ARGS084, CKES10, GEMT10S, GEMT10X, GEVT10S, GEVT10X, GGMT10S, GGMT10X, GGV10S, GGV10X, LBES101, LBET101, LBGS101, LBGT101, LVES101, LVET101, LVGS101, LVGT101, NAE101, NAEV101, NAGB101, NAGV101, SAEB101, SAEV101, SAGB101, SAGV101		



<b>GEV No.</b>	902024	<b>Ref. No.</b>	70048000 LA70048002 LAR70048000
<b>description</b>	door seal profile 2761 W 470mm L 560mm external size Qty 1		
<b>For models:</b>	AREN064, ARES064, ARGN064, ARGS064, GEMT07S, GEMT07X, GEVT07S, GEVT07X, GGMT07S, GGMT07X, GGVT07S, GGVT07X, LBES071, LBET071, LBGS071, LBGT071, LVES071, LVET071, LVGS071, LVGT071, NAEB071, NAEV071, NAGB071, NAGV071, SAEB071, SAEV071, SAGB071, SAGV071		

<b>GEV No.</b>	902450	<b>Ref. No.</b>	70044860 LA70044862 LAR70044860
<b>description</b>	door seal profile 2761 W 685mm L 775mm outer plug size Qty 1 suitable for LAINOX		
<b>For models:</b>	ABE084S, ABE104S, ABG084X, ABG104X		

<b>GEV No.</b>	902153	<b>Ref. No.</b>	70044810 LA70044812 LAR70044810
<b>description</b>	door seal profile 2761 W 550mm L 700mm external size Qty 1 suitable for LAINOX		
<b>For models:</b>	KME072S, KME072X, KMG072S, KMG072X, KVE072S, KVE072X, KVG072X, LBES072, LBET072, LBGS072, LBGT072, LVES072, LVET072, LVGS072, LVGT072, NAEB072, NAEV072, NAGB072, NAGV072, SAEB072, SAEV072, SAGB072, SAGV072		

<b>GEV No.</b>	902454	<b>Ref. No.</b>	70044880 70044882 LA70044882 LAR70044880 LAR70044882
<b>description</b>	door seal profile 2761 W 690mm L 775mm outer plug size Qty 1 suitable for LAINOX		
<b>For models:</b>	GEMT20S, GEMT20X, GEVT20S, GEVT20X, GGMT20S, GGMT20X, GGVT20S, GGVT20X, KME102X, KMG102S, KMG102X, KVE102S, KVE102X, KVG102X, LBES102, LBET102, LBGS102, LBGT102, LVES102, LVET102, LVGS102, LVGT102, NAEB102, NAEV102, NAGB102, NAGV102, SAEB102, SAEV102, SAGB102, SAGV102		

<b>GEV No.</b>	902452	<b>Ref. No.</b>	70044820 LA70044822 LAR70044820
<b>description</b>	door seal profile 2761 W 585mm L 615mm outer plug size Qty 1 suitable for LAINOX		
<b>For models:</b>	SCE071M, SME071S, SVE071P, SVE071S		

<b>GEV No.</b>	902154	<b>Ref. No.</b>	70044920 LA70044922 LAR70044920
<b>description</b>	door seal profile 2761 W 700mm L 1510mm external size Qty 1 suitable for LAINOX		
<b>For models:</b>	GEMT40S, GEMT40X, GEVT40S, GEVT40X, GGMT40S, GGMT40X, GGVT40S, GGVT40X, KME202S, KME202X, KMG202S, KMG202X, KVE202S, KVE202X, KVG202X, LBES202, LBET202, LBGS202, LBGT202, LVES202, LVET202, LVGS202, LVGT202, NAEB202, NAEV202, NAGB202, NAGV202, SAEB202, SAEV202, SAGB202, SAGV202		

<b>GEV No.</b>	902134	<b>Ref. No.</b>	70044830 LAR70044830 LAR70044832
<b>description</b>	door seal profile 2761 W 620mm L 780mm external size Qty 1 suitable for LAINOX		
<b>For models:</b>	KME101S, KME101X, KVE101S, KVE101X, SCE101M, SME101S, SM-G101S, SVE101S, SVG101S		

mechanical components, equipment accessories



<b>GEV No.</b>	902457	<b>Ref. No.</b>	70044840 70044842 LA70044842 LAR70044840 LAR70044842
<b>description</b>	door seal profile 2761 W 730mm L 770mm outer plug size Qty 1 suitable for LAINOX		
<b>For models:</b>	EVEA20S, SVEA20S		

<b>GEV No.</b>	901573	<b>Ref. No.</b>	70044270 LA70044270 LAR70044270
<b>description</b>	door seal profile 2770/2771 H 1550mm W 470mm outer plug size Qty 1		
<b>For models:</b>	EMT20P, EMT21P, EVT20D, GEMT10P, GEMT10T, GEMT20P, GEMT20T, GEMT21P, GEMT21T, GEVT10P, GEVT10T, GEVT20P, GEVT20T, GEVT20X, GEVT21P, GEVT21T, GGMT10P, GGMT10T, GGMT20P, GG-MT20T, GGMT21P, GGMT21T, GGVT10P, GGVT10T, GGVT20P, GGVT20T, GGVT21P, GGVT21T, GMT20D, GMT20P, GVT20D, HME102P, HME102T, HME102X, HMG102P, HMG102T, HMG102X, HVE061P, HVE102P, HVE102T, HVE102X, HVG102P, HVG102T, HVG102X, ME102D, ME102P, ME102T, MEMENT20D, MEMENT20P, MEMENT21D...(Other models you can see in the webshop)		

<b>GEV No.</b>	900493	<b>Ref. No.</b>	70044130 LA70044130 LAR70044130
<b>description</b>	door seal profile 2770/2771 H 1550mm W 680mm outer plug size Qty 1		
<b>For models:</b>	ABE156X, ABG156S, EPE156T, EPEV15T, EPG156T, EPGV15T, GSE201N, HME201P, HME201S, HME201T, HME201X, HMG201P, HMG201T, HMG-201X, HVE201P, HVE201S, HVE201T, HVE201X, HVG201P, HVG201T, HVG201X, MCE201M, MCG201M, ME201D, ME201H, ME201M, ME201P, ME201T, MG201D, MG201H, MG201M, MG201P, MG201T, PE156T, SCE201M, VE201D, VE201M, VE201P, VG201D, VG201M, VG201P		

<b>GEV No.</b>	900494	<b>Ref. No.</b>	70044140 LA70044140 LAR70044140
<b>description</b>	door seal profile 2770/2771 H 1550mm W 700mm outer plug size Qty 1		
<b>For models:</b>	GEMT40P, GEMT40T, GEVT40P, GEVT40T, GGMT40P, GGMT40T, GGVT40P, GGVT40T, HME202P, HME202S, HME202T, HME202X, HMG202P, HMG202T, HMG202X, HVE202P, HVE202T, HVE202X, HVG202P, HVG202T, HVG202X, MCE202M, MCG202M, ME202D, ME202H, ME202M, ME202P, ME202T, MEMENT40D, MEMENT40P, MEVT40D, MEVT40P, MG202D, MG202H, MG202M, MG202P, MG202T, MGMENT40D, MGMENT40P, MGVT40D, MGVT40P, VE202D, VE202M, VE202P, VG202D, VG202M, VG202P		



1			
<b>GEV No.</b>	900488	<b>Ref. No.</b>	70044330 LA70044330 LAR70044330
<b>description</b>	door seal profile 2770/2771 H 380mm W 420mm outer plug size Qty 1		
<b>For models:</b>	ACE04M, CE041M, CVE024S, CVE024X, MACE04M, MCE042M, MVE042P, SVE042S, VE042P		



1			
<b>GEV No.</b>	902183	<b>Ref. No.</b>	70044350 LA70044350 LAR70044350
<b>description</b>	door seal profile 2770/2771 H 440mm W 670mm outer plug size Qty 1		
<b>For models:</b>	ABE044M, ABE054M, BPE044M, BPE044P, BPE054M, BPE054P, ICEM051, ICET051, ICGM051, ICGT051, PE044M, PE054M, REP044M, REP044S, REP054M, REP054S, RGP044M, RGP044S, RGP054M, RGP054S		

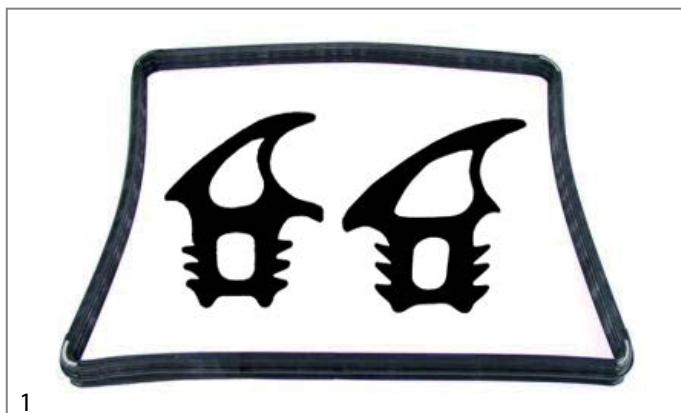

1			
<b>GEV No.</b>	900489	<b>Ref. No.</b>	70044340 LA70044340 LAR70044340
<b>description</b>	door seal profile 2770/2771 H 440mm W 600mm outer plug size Qty 1		
<b>For models:</b>	ACE05M, AVG05P, BPG044M, BPG044P, BPG054M, BPG054P, CBEN061, CBES061, CE051M, CG051M, CME061S, CME061X, CVE061S, CVE061X, CVEN061, CVES061, CVG061S, CVG061X, CVGN061, CVGS061, KME061S, KME061X, KVE061S, KVE061X, KVG061X, MACE05M, MACG05M, MCE051M, MCG051M, MVE051P, MVG051P, REV051M, REV051S, RGV051M, RGV051S, SCE051M, SVE051S, VE051P, VE055P, VG051P		

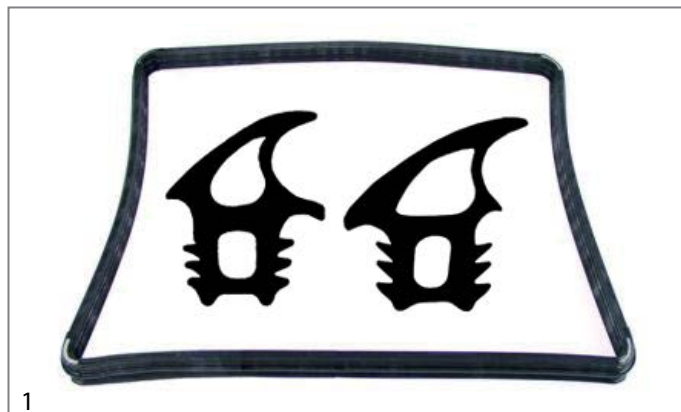

1			
<b>GEV No.</b>	901679	<b>Ref. No.</b>	70044210 LA70044210 LAR70044210
<b>description</b>	door seal profile 2770/2771 H 520mm W 470mm outer plug size suitable for LAINOX		
<b>For models:</b>	EMT06D, EVT06D, EVT06P, GEMT06P, GEMT06T, GEVT06P, GEVT06S, GEVT06T, GGMT06P, GGMT06T, GGVT06P, GGVT06T, GMT06D, GMT06P, GVT06D, GVT06P, MEMT06D, MEMT06P, MEVT06D, MEVT06P, MGMT06D, MGMT06P, MGVT06D, MGVT06P		

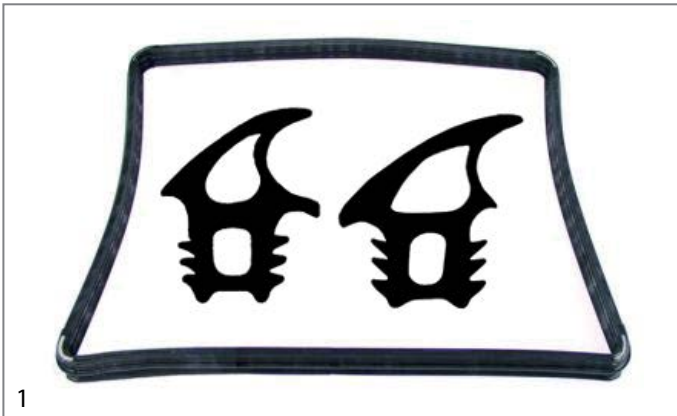

1

<b>GEV No.</b>	900490	<b>Ref. No.</b>	70044100 LA70044100 LAR70044100
<b>description</b>	door seal profile 2770/2771 H 520mm W 620mm outer plug size Qty 1		
<b>For models:</b>	EPG056T, EPGV05T, HME061P, HME061T, HME061X, HMG061P, HMG061T, HMG061X, HVE061P, HVE061T, HVE061X, HVG061P, HVG061T, HVG061X, ME061D, ME061H, ME061M, ME061P, ME061T, MG061D, MG061H, MG061M, MG061P, MG061T, VE061D, VE061M, VE061P, VG061D, VG061M, VG061P		

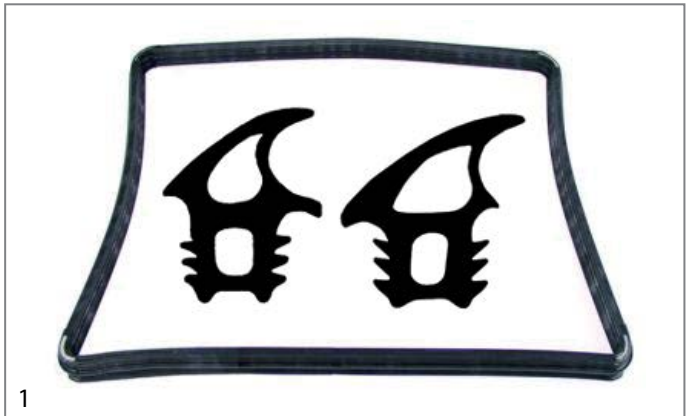

1

<b>GEV No.</b>	901716	<b>Ref. No.</b>	70044400 70044401 LA70044400 LA70044401 LAR70044400 LAR70044401
<b>description</b>	door seal profile 2770/2771 H 610mm W 600mm outer plug size Qty 1		
<b>For models:</b>	REV071M, REV071S, RGV071M, RGV071S		

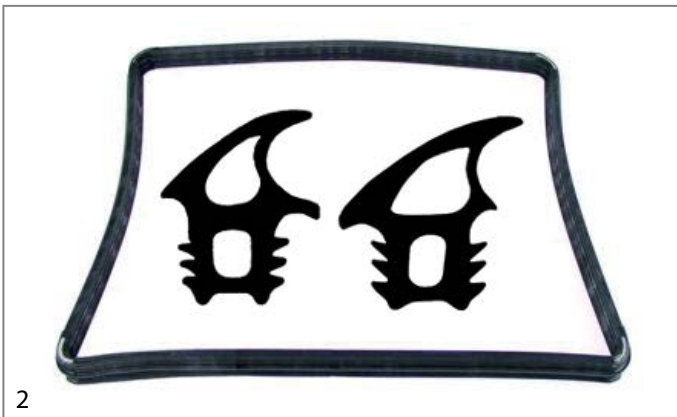

2

<b>GEV No.</b>	900788	<b>Ref. No.</b>	70044230 LA70044230 LAR70044230
<b>description</b>	door seal profile 2770/2771 H 580mm W 680mm outer plug size Qty 1		
<b>For models:</b>	AME07D, AME07P, APE06, APE07, AVE07D, AVE07P, BPE064M, BPE064P, BPE074M, BPE074P, BPG064M, BPG064P, BPG074M, BPG074P, CE071M, CG071M, MACE07M, MACG07M, MCE071M, MCG071M, MME071P, MMG071P, MVE071M, MVE071P, MVG071P, PE064M, PE064P, PE074M, PE074P, SIE071P, XAME07D		



1

<b>GEV No.</b>	901276	<b>Ref. No.</b>	70044220 LA70044220 LAR70044220
<b>description</b>	door seal profile 2770/2771 H 800mm W 470mm outer plug size Qty 1 suitable for LAINOX		
<b>For models:</b>	EMT10D, EVT10P, GEMT10P, GEMT10T, GEVT10P, GEVT10T, GGMT10P, GGMT10T, GGV10P, GGV10T, MEMT10D, MEMT10P, MEVT10D, MEVT10P, MGMT10D, MGMT10P, MGVT10D, MGVT10P		





1

<b>GEV No.</b>	900491	<b>Ref. No.</b>	70044110 LA70044110 LAR70044110
<b>description</b>	door seal profile 2770/2771 H 800mm W 680mm outer plug size Qty 1		
<b>For models:</b>	ACE10M, ACG10M, AME10D, APG08M, APG10M, AVE10D, AVE10P, AVG10D, BPE084M, BPE084P, BPE104M, BPE104P, BPG084M, BPG084P, BPG104M, BPG104P, CE100M, CG100M, EPE086T, EPEV08T, EPG086T, EPGV08T, HME101P, HME101S, HME101T, HME101X, HMG101P, HMG101T, HMG101X, HVE101P, HVE101S, HVE101T, HVE101X, HVG101P, HVG101T, HVG101X, MACE10M, MACG10M, MCE101M, MCG101M, ME101D, ME101H, ME101M, ME101P, ME101T, MG101D, MG101H, MG101M, MG101P, MG101T...(Other models you can see in the webshop)		



1

<b>GEV No.</b>	901603	<b>Ref. No.</b>	70044240 LA70044240 LAR70044240
<b>description</b>	door seal profile 2770/2771 H 800mm W 760mm outer plug size Qty 1		
<b>For models:</b>	AVG20D, CE200M, CG200M, MACE20M, MACG20M, MCE102M, MCG102M, MME102P, MMG102P, MVE102P, MVG102P		

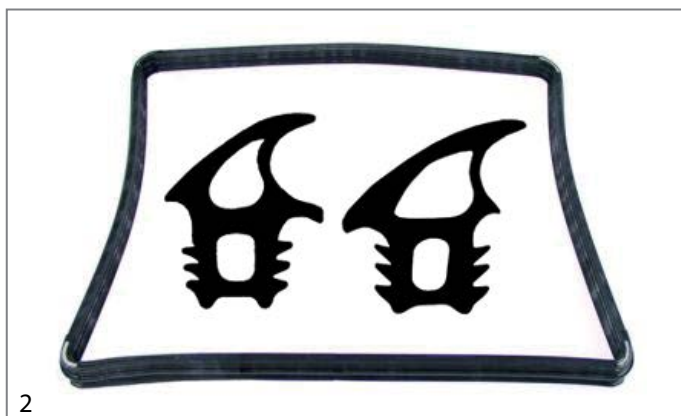

2

<b>GEV No.</b>	900492	<b>Ref. No.</b>	70044120 LA70044120 LAR70044120
<b>description</b>	door seal profile 2770/2771 H 800mm W 700mm outer plug size Qty 1		
<b>For models:</b>	EMT20P, EVT20D, GEMT20P, GEMT20T, GEVT20P, GEVT20T, GEVT20X, GGMT20P, GGMT20T, GGVT20P, GGVT20T, GMT20D, GMT20P, GVT20D, HME102P, HME102S, HME102T, HME102X, HMG102P, HMG102T, HMG102X, HVE102P, HVE102S, HVE102T, HVE102X, HVG102P, HVG102T, HVG102X, ME102D, ME102H, ME102M, ME102P, ME102T, MEMT20D, MEMT20P, MEVT20D, MEVT20P, MG102D, MG102H, MG102M, MG102P, MG102T, MGMT20D, MGMT20P, MGVT20D, MGVT20P, VE102D, VE102M, VE102P, VG102D...(Other models you can see in the webshop)		

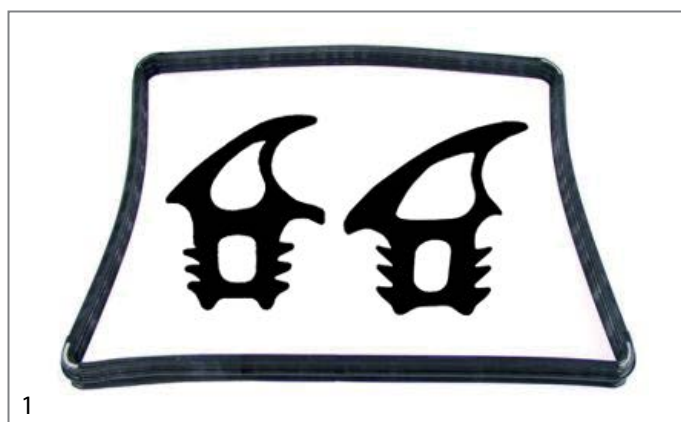

1

<b>GEV No.</b>	901402	<b>Ref. No.</b>	70044410 LA70044410 LAR70044410
<b>description</b>	door seal profile 2770/2771 H 820mm W 600mm outer plug size Qty 1		
<b>For models:</b>	REV101M, REV101S, RGV101M, RGV101S		

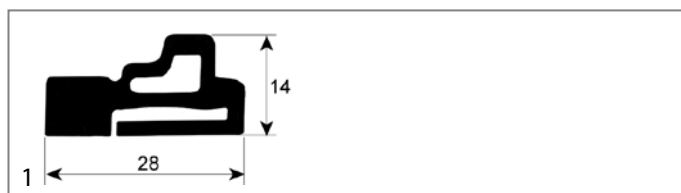

1

<b>GEV No.</b>	900745	<b>Ref. No.</b>	70044300 LAR70044300
<b>description</b>	door seal profile 2954 L 700mm		
<b>For models:</b>	GEMT40P, GEMT40T, GEVT40P, GEVT40T, GGMT40P, GGMT40T, GGVT40P, GGVT40T, GSE201N, HME201P, HME201S, HME201T, HME201X, HME202P, HME202S, HME202T, HME202X, HMG201P, HMG201T, HMG201X, HMG202P, HMG202T, HMG202X, HVE201P, HVE201S, HVE201T, HVE201X, HVE202P, HVE202T, HVE202X, HVG201P, HVG201T, HVG201X, HVG202P, HVG202T, HVG202X, ME201D, ME201H, ME201M, ME201P, ME201T, ME202D, ME202H, ME202M, ME202P, ME202T, MEMT40D, MEMT40P, MEVT40D, MEVT40P...(Other models you can see in the webshop)		

mechanical components, equipment accessories



door seals with fixing hook



<b>GEV No.</b>	902463	<b>Ref. No.</b>	70044000 LA70044000 LAR70044000
<b>description</b>	door seal L 2660mm 4-sided with 8 mounting clips		
<b>For models:</b>	A08PES, A08PES+UM, A10PES, A10PES+UM		

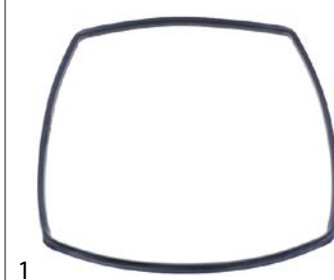

<b>GEV No.</b>	901460	<b>Ref. No.</b>	70044020 LA70044020 LAR70044020
<b>description</b>	door seal W 375mm with 4 mounting clips H 330mm		
<b>For models:</b>	REC023M		

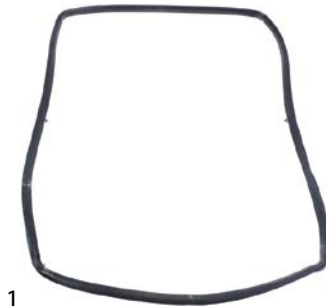

<b>GEV No.</b>	901371	<b>Ref. No.</b>	70044030 LA70044030 LAR70044030
<b>description</b>	door seal L 540mm W 390mm with 6 mounting clips		
<b>For models:</b>	A05RES, A05RES+UM		

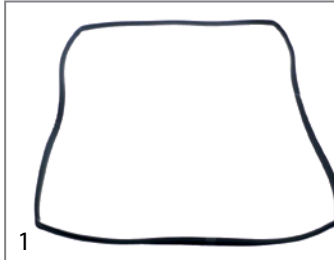

<b>GEV No.</b>	901278	<b>Ref. No.</b>	70044010 LAR70044010
<b>description</b>	door seal W 550mm H 750mm external size		
<b>For models:</b>	A08RES, A08RES+UM, A10RES, A10RES+UM		

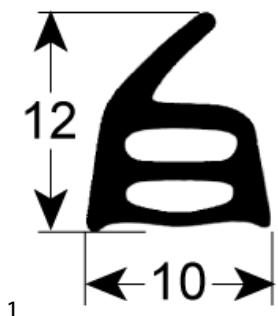

<b>GEV No.</b>	901817	<b>Ref. No.</b>	70044710 LA70044710 LAR70044710
<b>description</b>	door seal L 540mm W 400mm 4-sided with 10 mounting clips LAINOX for model REC051 and REC051M		
<b>For models:</b>	REC051M, RGC051M		

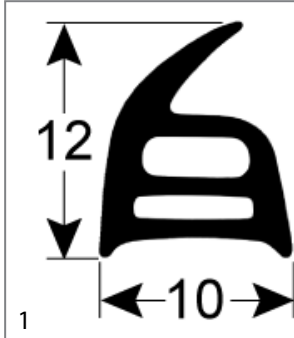

<b>GEV No.</b>	901434	<b>Ref. No.</b>	70044040 LA70044040 LAR70044040
<b>description</b>	door seal W 600mm with 6 mounting clips H 400mm		
<b>For models:</b>	A05PES, A05PES+UM		

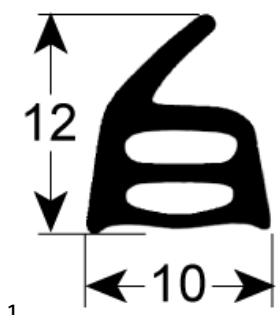

<b>GEV No.</b>	902182	<b>Ref. No.</b>	70044730 LA70044730 LAR70044730
<b>description</b>	door seal L 760mm W 550mm 4-sided with 14 mounting clips		
<b>For models:</b>	REC101M, RGC101M		

mechanical components, equipment accessories



gaskets for tray rack trolleys



1

<b>GEV No.</b>	901160	<b>Ref. No.</b>	70044320 70044360 70044362 LAR70044320 LAR70044360 LAR70044362
<b>description</b>	tray rack trolley gasket L <700mm 3-piece		
<b>For models:</b>	ABE156X, ABG156S, EPE156T, EPEV15T, EPG156T, EPGV15T, GEMT40P, GEMT40S, GEMT40T, GEMT40X, GEVT40P, GEVT40S, GEVT40T, GEVT40X, GGMT40P, GGMT40S, GGMT40T, GGMT40X, GGV140P, GGV140S, GGV140T, GGV140X, GSE201N, HME201P, HME201S, HME201T, HME201X, HME202P, HME202S, HME202T, HME202X, HMG201P, HMG201T, HMG201X, HMG202P, HMG202T, HMG202X, HVE201P, HVE201S, HVE201T, HVE201X, HVE202P, HVE202T, HVE202X, HVG201P, HVG201T, HVG201X, HVG202P, HVG202T, HVG202X...(Other models you can see in the webshop)		

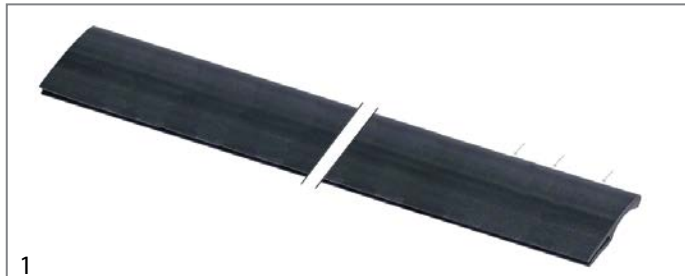

1

<b>GEV No.</b>	901161	<b>Ref. No.</b>	80100910 LA80100910 LAR80100910
<b>description</b>	tray rack trolley gasket L 1000mm		
<b>For models:</b>	ABE156X, ABG156S, AREN154, ARES154, ARGN154, ARGS154, EPE156T, EPEV15T, EPG156T, EPGV15T, GEMT21P, GEMT21S, GEMT21T, GEMT21X, GEMT40P, GEMT40S, GEMT40T, GEMT40X, GEVT21P, GEVT21S, GEVT21T, GEVT21X, GEVT40P, GEVT40S, GEVT40T, GEVT40X, GGMT21P, GGMT21S, GGMT21T, GGMT21X, GGMT40P, GGMT40S, GGMT40T, GGMT40X, GGV140P, GGV140S, GGV140T, GGV140X, GGV21P, GGV21S, GGV21T, GGV21X, GGV240P, GGV240S, GGV240T, GGV240X, GSE201N, HME201P, HME201S, HME201T, HME201X, HME202P, HME202S, HME202T...(Other models you can see in the webshop)		



1

<b>GEV No.</b>	901711	<b>Ref. No.</b>	70044370 LAR70044370
<b>description</b>	tray rack trolley gasket L 510mm 3-piece		
<b>For models:</b>	GEMT21P, GEMT21T, GEVT21P, GEVT21T, GGMT21P, GGMT21T, GGV21P, GGV21T		

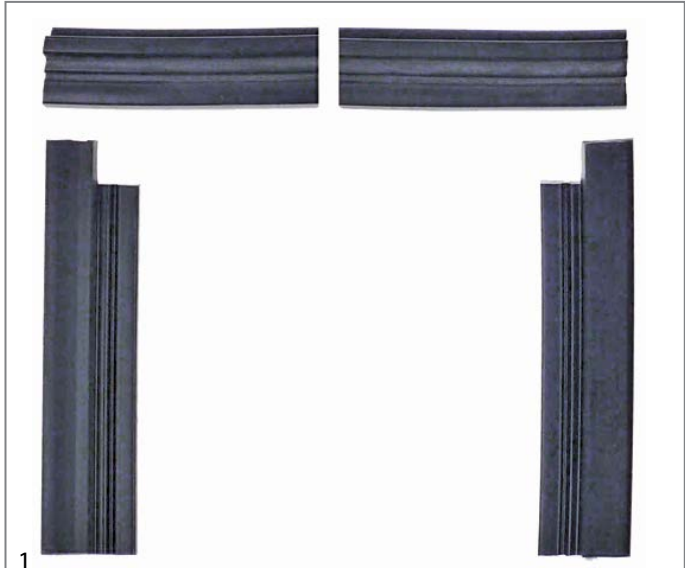

1

<b>GEV No.</b>	902462	<b>Ref. No.</b>	70044361 LAR70044361
<b>description</b>	tray rack trolley gasket L 750mm 3-piece		
<b>For models:</b>	AREN154, ARES154, ARGN154, ARGS154, KME201S, KME201X, KM-G201S, KMG201X, KVE201S, KVE201X, KVG201X		

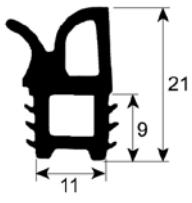

<b>GEV No.</b>	900776	<b>Ref. No.</b>	70041150 LAR70041150
<b>description</b>	tray rack trolley gasket profile 4050 L 1020mm Qty 1		
<b>For models:</b>	CEC40M, CGC24M, CGC40M, MEC20H, MEC20P, MEC20X, MEC24H, MEC40H, MEC40M, MEC40P, MED40D, MEK21H, MGC20H, MGC20X, MGC24H, MGC40H, MGC40M, MGC40P, MGC40X, VEC20M, VEC20P, VEC20X, VGC20H, VGC24H		

### O-rings

#### EPDM

ø5.34mm



<b>GEV No.</b>	510409	<b>Ref. No.</b>	70045010 LA70045010 LAR70045010
<b>description</b>	O-ring EPDM thickness 5.34mm ID ø 56.52mm Qty 1 pcs		
<b>For models:</b>	AME07D, AME07P, AME10D, EMT06D, EMT10D, EMT20P, EMT21P, GEMT06P, GEMT06T, GEMT10P, GEMT10T, GEMT20P, GEMT20S, GEMT20T, GEMT20X, GEMT21P, GEMT21T, GEMT40S, GEMT40X, GEVT21P, GEVT21T, GEVT40S, GEVT40X, GGMT21P, GGMT21T, GGMT40S, GGMT40X, GGVT21P, GGVT21T, GGVT40S, GGVT40X, GSE201N, HME061P, HME061T, HME061X, HME101P, HME101S, HME101T, HME101X, HME102P, HME102S, HME102T, HME102X, HME201P, HME201S, HME201T, HME201X, KME072S, KME072X, KME081S...(Other models you can see in the webshop)		

### miscellaneous

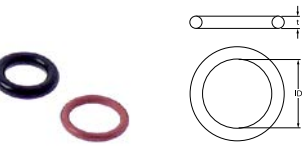

<b>GEV No.</b>	532492	<b>Ref. No.</b>	70010050 LAR70010050
<b>description</b>	O-ring set EPDM thickness 1.78/2.62mm ID ø 9.25/7.59mm Qty 2 pcs		
<b>For models:</b>	ABE084S, ABE104S, ABE156X, ABG084X, ABG104X, ABG156S, AREN064, AREN084, AREN154, ARES064, ARES084, ARES154, ARGN064, ARGN084, ARGN154, ARGS064, ARGS084, ARGS154, CEV026S, CEV026X, CEV061S, CEV061X, CEV101S, CEV101X, CKES10, CME061S, CME061X, COEN026, COEN061, COEN101, COES026, COES061, COES101, CVE024S, CVE024X, CVE061S, CVE061X, CVEN061, CVES061, CVG061S, CVG061X, CVGN061, CVGS061, EMT20P, EMT21P, EPE056T, EPE086T, EPE156T, EPEV05T, EPEV08T...(Other models you can see in the webshop)		

### Viton

ø2.00mm



<b>GEV No.</b>	512506	<b>Ref. No.</b>	70010080 LA70010080 LAR70010080
<b>description</b>	O-ring Viton thickness 2mm ID ø 14mm Qty 1 pcs		
<b>For models:</b>	AREN064, AREN084, AREN154, ARES064, ARES084, ARES154, ARGN064, ARGN084, ARGN154, ARGS064, ARGS084, ARGS154, CEV026S, CEV026X, CEV061S, CEV061X, CEV101S, CEV101X, CKES10, CME061S, CME061X, CVE024S, CVE024X, CVE061S, CVE061X, CVG061S, CVG061X, GEMT07S, GEMT07X, GEMT10S, GEMT10X, GEMT20S, GEMT20X, GEMT21S, GEMT21X, GEMT40S, GEMT40X, GEVT07S, GEVT07X, GEVT10S, GEVT10X, GEVT20S, GEVT20X, GEVT21S, GEVT21X, GEVT40S, GEVT40X, GGMT07S, GGMT07X, GGMT10S...(Other models you can see in the webshop)		

### sealing washers

#### fibre gaskets



<b>GEV No.</b>	510404	<b>Ref. No.</b>	682770
<b>description</b>	flat gasket fibre ED ø 44mm ID ø 34mm thickness 2mm Qty 1 pcs		

### graphite gaskets



<b>GEV No.</b>	696702	<b>Ref. No.</b>	63140070 LA63140070 LAR63140070
<b>description</b>	gasket graphite ED ø 84mm ID ø 61mm thickness 3mm Qty 1 pcs		
<b>For models:</b>	ABG064M, ABG074M, ARGN064, ARGS064, BPG044M, BPG044P, BPG054M, BPG054P, BPG064M, BPG064P, BPG074M, BPG074P, CVG061S, CVG061X, CVGN061, CVGS061, EPG056T, EPGV05T, GGMT06P, GGMT06T, GGMT07S, GGMT07X, GGVT06P, GGVT06T, GGVT07S, GGVT07X, HMG061P, HMG061T, HMG061X, HVG061P, HVG061T, HVG061X, ICGM051, ICGM071, ICGM101, ICGT051, ICGT071, ICGT101, KMG081S, KMG081X, KMG201S, KMG201X, KVG061X, KVG072X, KVG081S, KVG081X, KVG201X, LBG05071, LBG07071, LVGS071...(Other models you can see in the webshop)		



shaft gaskets

shaft gaskets



1			
<b>GEV No.</b>	511171	<b>Ref. No.</b>	50505880 70020040 LA70020040 LAR50505880 LAR70020040
<b>description</b>	shaft seal ID ø 14.5mm ED ø 20mm thickness 3mm		
<b>For models:</b>	AME07D, AME07P, APE06, APE07, AREN064, ARES064, ARGN064, ARGS064, AVE07D, AVE07P, BPE064M, BPE064P, BPE074M, BPE074P, BPG064M, BPG064P, BPG074M, BPG074P, CE071M, CE106M, CG071M, CG105M, CG106M, CVE105H, CVE105M, CVG105H, CVG105M, EC106M, EM006H, EM006M+SC, EM106H, EM106M, EM106M+SC, EM106P, EMT06D, EPE056T, EPEV05T, EPG056T, EPGV05T, EV006M, EV006P, EV106H, EV106M, EV106M+SC, EV106P, EVT06D, EVT06P, FE051M, FE051X, FE105M...(Other models you can see in the web-shop)		



1			
<b>GEV No.</b>	511170	<b>Ref. No.</b>	50505895 70020010 LAR50505895 LAR70020010
<b>description</b>	shaft seal ID ø 7mm ED ø 22mm thickness 7mm		
<b>For models:</b>	CVE004H, CVE004M, CVE104H, CVE104M, ME004L, ME004S, ME104L, ME104S, VE004D, VE004H, VE004M, VE004S, VE004X, VE104D, VE104H, VE104M, VE104S, VE104X		



1			
<b>GEV No.</b>	550550	<b>Ref. No.</b>	7070151
<b>description</b>	shaft sealing for fan motor		
<b>For models:</b>	VE102MX		



1			
<b>GEV No.</b>	511172	<b>Ref. No.</b>	50505890 70020050 LA70020050 LAR50505890 LAR70020050
<b>description</b>	shaft sealing ID ø 24mm ED ø 29mm thickness 3mm		
<b>For models:</b>	ABE084S, ABE104S, ABE156X, ABG064M, ABG074M, ABG084X, ABG104X, ABG156S, ACE10M, ACG10M, AME10D, APG08M, APG10M, AREN084, AREN154, ARES084, ARES154, ARGN084, ARGN154, ARGS084, ARGS154, AVE10D, AVE10P, AVG10D, AVG20D, BPE084M, BPE084P, BPE104M, BPE104P, BPG084M, BPG084P, BPG104M, BPG104P, CE100M, CE110M, CE200M, CE210M, CEC40M, CES24M, CES40M, CG100M, CG110M, CG200M, CG210M, CGC24M, CGC40M, CGS24M, CGS40M, CKES10, EC020M...(Other models you can see in the webshop)		

special gaskets

for combi-steamers



1			
<b>GEV No.</b>	512507	<b>Ref. No.</b>	70050090 LA70050090 LAR70050090
<b>description</b>	gasket suitable for LAINOX ED ø 23mm ID ø 15.5mm rubber thickness 3.2mm 21 Qty 1 pcs		
<b>For models:</b>	ABG156S, ARGN064, ARGN084, ARGN154, ARGS064, ARGS084, ARGS154, CVG061S, CVG061X, GGMT07S, GGMT07X, GGMT10S, GGMT10X, GGMT20S, GGMT20X, GGMT21S, GGMT21X, GGMT40S, GGMT40X, GGVT07S, GGVT07X, GGVT10S, GGVT10X, GGVT20S, GGVT20X, GGVT21S, GGVT21X, GGVT40S, GGVT40X, KMG072S, KMG072X, KMG081S, KMG081X, KMG101S, KMG101X, KMG102S, KMG102X, KMG201S, KMG201X, KMG202S, KMG202X, KMGA20S, KMG20X, KVG061X, KVG072X, KVG081S, KVG081X, KVG101X, KVG102X, KVG201X...(Other models you can see in the webshop)		

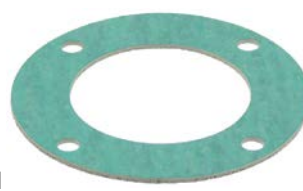

1			
<b>GEV No.</b>	699384	<b>Ref. No.</b>	63140050 LA63140050 LAR63140050
<b>description</b>	gasket suitable for LAINOX ED ø 84mm ID ø 50mm fibre thickness 2mm hole distance 50mm hole ø 6mm		
<b>For models:</b>	ABG064M, ABG074M, ABG084X, ABG104X, ABG156S, ACG10M, APG08M, APG10M, ARGN064, ARGN084, ARGN154, ARGS064, ARGS084, ARGS154, AVG05P, AVG10D, AVG20D, BPG044M, BPG044P, BPG054M, BPG054P, BPG064M, BPG064P, BPG074M, BPG074P, BPG084M, BPG084P, BPG104M, BPG104P, CG051M, CG071M, CG100M, CG200M, CVG061S, CVG061X, CVGN061, CVGS061, EPG056T, EPG086T, EPG156T, EPGV05T, EPGV08T, EPGV15T, GGMT06P, GG-MT06T, GGMT07S, GGMT07X, GGMT10P, GGMT10S, GGMT10T...(Other models you can see in the webshop)		

mechanical components, equipment accessories





<b>GEV No.</b>	694955	<b>Ref. No.</b>	63140010 LA63140010 LAR63140010
<b>description</b>	gasket suitable for LAINOX L 80mm W 65mm combi-steamer ID ø 51mm graphite thickness 3mm hole distance 45x60mm		
<b>For models:</b>	ABG064M, ABG074M, ABG084X, ABG104X, ABG156S, ARGN064, ARGN084, ARGN154, ARG5064, ARG5084, ARG5154, AVGO5P, BPG044M, BPG044P, BPG054M, BPG054P, BPG064M, BPG064P, BPG074M, BPG074P, BPG084M, BPG084P, BPG104M, BPG104P, CG051M, CG071M, CVG061S, CVG061X, CVGN061, CVGS061, EPG056T, EPG086T, EPG156T, EPGV05T, EPGV08T, EPGV15T, GGMT06P, GGMT06T, GGMT07S, GGMT07X, GGMT10P, GGMT10S, GGMT10T, GGMT10X, GGMT20P, GGMT20S, GGMT20T, GGMT20X, GGMT21P, GGMT21S...(Other models you can see in the webshop)		



<b>GEV No.</b>	699383	<b>Ref. No.</b>	63140080 LA63140080 LAR63140080
<b>description</b>	gasket suitable for LAINOX Qty 1m ED ø 126mm ID ø 90mm graphite thickness 3mm hole distance 42mm hole ø 7mm		
<b>For models:</b>	ABG084X, ABG104X, ABG156S, ARGN084, ARGN154, ARG5084, ARG5154, BPG084M, BPG084P, BPG104M, BPG104P, EPG086T, EPG156T, EPGV08T, EPGV15T, GGMT10P, GGMT10S, GGMT10T, GGMT10X, GGMT20P, GGMT20S, GGMT20T, GGMT20X, GGMT21P, GGMT21S, GGMT21T, GGMT21X, GGMT40P, GGMT40S, GGMT40T, GGMT40X, GGVT10P, GGVT10S, GGVT10T, GGVT10X, GGVT20P, GGVT20S, GGVT20T, GGVT20X, GGVT21P, GGVT21S, GGVT21T, GGVT21X, GGVT40P, GGVT40S, GGVT40T, GGVT40X, HMG101P, HMG101T, HMG101X...(Other models you can see in the webshop)		



<b>GEV No.</b>	902464	<b>Ref. No.</b>	70010130 LA70010130 LAR70010130
<b>description</b>	gasket suitable for LAINOX Qty 1m ED ø 80mm ID ø 50mm silicone thickness 3mm hole distance 54mm hole ø 6mm		
<b>For models:</b>	AREN084, CKES10, GEMT10S, GEVT10S, GEVT21S, KME101S, KME101X, KME201S, KVE081S, KVE101S, KVE101X, KVG081S, NAEV071, SAEB071		



<b>GEV No.</b>	699247	<b>Ref. No.</b>	70045120 LAR70045120
<b>description</b>	gasket set for combi-steamer		
<b>For models:</b>	ABE084S, ABE104S, ABE156X, ABG084X, ABG104X, ABG156S, AREN064, AREN084, AREN154, ARES064, ARES084, ARES154, ARGN064, ARGN084, ARGN154, ARG5064, ARG5084, ARG5154, CBEN061, CBES061, CEV026S, CEV026X, CEV061S, CEV061X, CEV101S, CEV101X, CKES10, CME061S, CME061X, COEN026, COEN061, COEN101, COES026, COES061, COES101, CVE024S, CVE024X, CVE061S, CVE061X, CVEN061, CVES061, CVG061S, CVG061X, CVGN061, CVGS061, EVEA20S, GEMT07S, GEMT07X, GEMT10S, GEMT10X...(Other models you can see in the webshop)		



<b>GEV No.</b>	699385	<b>Ref. No.</b>	70045100 LAR70045100
<b>description</b>	gasket set suitable for LAINOX for cleaning system		
<b>For models:</b>	EMT20P, GEMT10P, GEMT10T, GEMT20P, GEMT20T, GEVT10P, GEVT10T, GEVT20P, GEVT20T, GGMT10P, GGMT10T, GGMT20P, GGMT20T, GGVT10P, GGVT10T, GGVT20P, GGVT20T, GMT20P, HME102P, HME102S, HME102T, HME102X, HMG102P, HMG102T, HMG102X, HVE102P, HVE102S, HVE102T, HVE102X, HVG102P, HVG102T, HVG102X, KME072S, KME072X, KME102X, KME201S, KME201X, KME202S, KME202X, KMG072S, KMG072X, KMG102S, KMG102X, KMG201S, KMG201X, KMG202S, KMG202X, KVE072S, KVE072X, KVE102S...(Other models you can see in the webshop)		



<b>GEV No.</b>	699246	<b>Ref. No.</b>	70045110 LAR70045110
<b>description</b>	service kit gasket for combi-steamer		
<b>For models:</b>	EMT21P, EPE156T, EPEV15T, EPG156T, EPGV15T, GEMT21P, GEMT21T, GEMT40P, GEMT40T, GEVT21P, GEVT21T, GEVT40P, GEVT40T, GGMT21P, GGMT21T, GGMT40P, GGMT40T, GGVT21P, GGVT21T, GGVT40P, GGVT40T, GSE201N, HME201P, HME201S, HME201T, HME201X, HME202P, HME202S, HME202T, HME202X, HMG201P, HMG201T, HMG201X, HMG202P, HMG202T, HMG202X, HVE201P, HVE201S, HVE201T, HVE201X, HVE202P, HVE202T, HVE202X, HVG201P, HVG201T, HVG201X, HVG202P, HVG202T, HVG202X, ME201T...(Other models you can see in the webshop)		



miscellaneous



<b>GEV No.</b>	550862	<b>Ref. No.</b>	70045090 LAR70045090
<b>description</b>	gasket set for wash arm		
<b>For models:</b>	EPE056T, EPE086T, EPEV05T, EPEV08T, EPG056T, EPG086T, EPGV05T, EPGV08T, GEMT06P, GEMT06T, GEVT06P, GEVT06T, GGMT06P, GGMT06T, GGVTO6P, GGVTO6T, GMT06P, HME061P, HME061T, HME061X, HME101P, HME101S, HME101T, HME101X, HMG061P, HMG061T, HMG061X, HMG101P, HMG101T, HMG101X, HVE061P, HVE061T, HVE061X, HVE101P, HVE101S, HVE101T, HVE101X, HVG061P, HVG061T, HVG061X, HVG101P, HVG101T, HVG101X, ME061T, ME101T, MEMT06P, MG061T, MG101T, MGMT06P, PEV08T		

miscellaneous



<b>GEV No.</b>	697932	<b>Ref. No.</b>	10205120 919006 LAR10205120
<b>description</b>	spring for contollers/switches shaft diameter 6x4.6mm ømm L 40mm W 23mm H 7mm wire gauge ø 1mm		
<b>For models:</b>	CVE004H, CVE104H, CVE105H, CVG105H, EM006H, EM010H, EM106H, EM106P, EM110H, EM110P, EM210H, EM210P, EV006P, EV010H, EV010P, EV106H, EV106P, EV110H, EV110P, EV210H, EV210P, FEI102P, FME101AX, FME201SX, GMD020H, GM106H, GM106P, GM110H, GM110P, GM210H, GM210P, GV006H, GV010H, GV020H, GV106H, GV106P, GV110H, GV110P, GV210H, GV210P, ME106D, ME106H, ME106P, ME110D, ME110H, ME110P, ME120D, ME120H, ME120P, ME210D...(Other models you can see in the webshop)		

springs

torsion springs

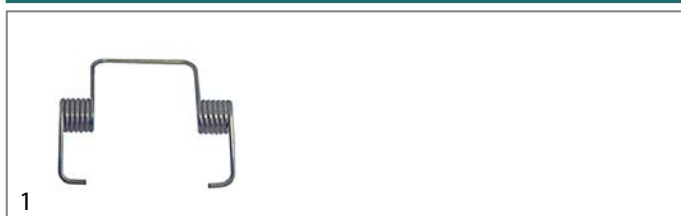

<b>GEV No.</b>	690095	<b>Ref. No.</b>	50001196 61620012 LA61620012 LAR50001196 LAR61620012
<b>description</b>	torsion spring ø 6mm L2 15mm wire gauge ø 0.9mm L1 2x6mm L3 15mm Qty 1 pcs for closing hub		
<b>For models:</b>	ACE04M, ACE05M, ACE10M, ACG10M, AME07D, AME07P, AME10D, APE06, APE07, APG08M, APG10M, AVE07D, AVE07P, AVE10D, AVE10P, AVG05P, AVG10D, AVG20D, BPE044M, BPE044P, BPE054M, BPE054P, BPE064M, BPE064P, BPE074M, BPE074P, BPE084M, BPE084P, BPE104M, BPE104P, BPG044M, BPG044P, BPG054M, BPG054P, BPG064M, BPG064P, BPG074M, BPG074P, BPG084M, BPG084P, BPG104M, BPG104P, CE041M, CE051M, CE071M, CE100M, CE106M, CE110M, CE200M, CE210M...(Other models you can see in the webshop)		

hose reels and spray guns

spray guns



<b>GEV No.</b>	542062	<b>Ref. No.</b>	62200028 LA62200028 LAR62200028
<b>description</b>	spray gun for appliances 1/2" IT L 225mm type LAINOX		
<b>For models:</b>	GEMT07S, GEMT07X, GEMT10S, GEMT10X, GEMT20S, GEMT20X, GEMT21S, GEMT21X, GEMT40S, GEMT40X, GEVT07S, GEVT07X, GEVT10S, GEVT10X, GEVT20S, GEVT20X, GEVT21S, GEVT21X, GEVT40S, GEVT40X, GGMT07S, GGMT07X, GGMT10S, GGMT10X, GGMT20S, GGMT20X, GGMT21S, GGMT21X, GGMT40S, GGMT40X, GGVTO7S, GGVTO7X, GGVTO10S, GGVTO10X, GGVTO20S, GGVTO20X, GGVTO21S, GGVTO21X, GGVTO40S, GGVTO40X, HME201X, HME202X, HMG201X, HMG202X, HVE201X, HVE202X, HVG201X, HVG202X, KME201S, KME201X...(Other models you can see in the webshop)		

compression springs



<b>GEV No.</b>	690091	<b>Ref. No.</b>	50202710 61620041 LA61620041 LAR50202710 LAR61620041
<b>description</b>	compression spring ø 12mm L 49mm wire gauge ø 1mm		
<b>For models:</b>	ACE04M, ACE05M, ACE10M, ACG10M, AME07D, AME07P, AME10D, APE06, APE07, APG08M, APG10M, AVE07D, AVE07P, AVE10D, AVE10P, AVG05P, AVG10D, AVG20D, BPE044M, BPE044P, BPE054M, BPE054P, BPE064M, BPE064P, BPE074M, BPE074P, BPE084M, BPE084P, BPE104M, BPE104P, BPG044M, BPG044P, BPG054M, BPG054P, BPG064M, BPG064P, BPG074M, BPG074P, BPG084M, BPG084P, BPG104M, BPG104P, CE041M, CE051M, CE071M, CE100M, CE106M, CE110M, CE200M, CE210M...(Other models you can see in the webshop)		

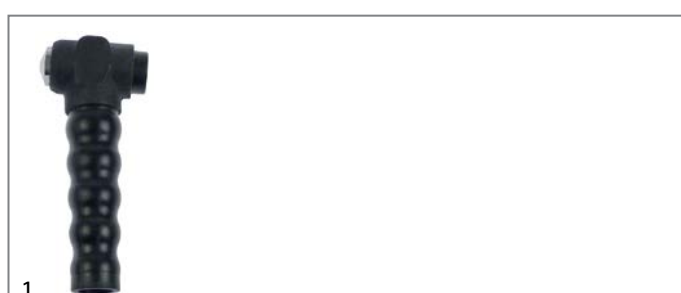

<b>GEV No.</b>	542098	<b>Ref. No.</b>	LA62200133
<b>description</b>	spray gun for appliances 3/8" IT L 130mm type LAINOX		



			
<b>GEV No.</b>	542404	<b>Ref. No.</b>	62200058 LAR62200058
<b>description</b>	shower hose connections 1/2" L 2500mm unbraided nominal-ø DN8mm		
<b>For models:</b>	GEMT07S, GEMT07X, GEMT10S, GEMT10X, GEMT20S, GEMT20X, GEMT21S, GEMT21X, GEMT40S, GEMT40X, GEVT07S, GEVT07X, GEVT10S, GEVT10X, GEVT20S, GEVT20X, GEVT21S, GEVT21X, GEVT40S, GEVT40X, GGMT07S, GGMT07X, GGMT10S, GGMT10X, GGMT20S, GGMT20X, GGMT21S, GGMT21X, GGMT40S, GGMT40X, GGVT07S, GGVT07X, GGVT10S, GGVT10X, GGVT20S, GGVT20X, GGVT21S, GGVT21X, GGVT40S, GGVT40X, HME201X, HME202X, HMG201X, HMG202X, HVE201X, HVE202X, HVG201X, HVG202X, KME201S, KME201X...(Other models you can see in the webshop)		

## hose reels

### appliance hose reels

			
<b>GEV No.</b>	542316	<b>Ref. No.</b>	62200172 LA62200172 LAR62200172
<b>description</b>	evaporator complete with spray gun hose length 1.6m connection John Guest 10mm hose ø 6x12mm		
<b>For models:</b>	AREN064, AREN084, ARES064, ARES084, ARGN064, ARGN084, ARGS064, ARGS084, NAEB071, NAEB071R, NAEB072R, NAEB101, NAEB101R, NAEB102, NAEB102R, NAEB072, NAEB071, NAEB071R, NAEB072, NAEB072R, NAEV101, NAEV101R, NAEV102, NAEV102R, NAGB071, NAGB071R, NAGB072, NAGB072R, NAGB101, NAGB101R, NAGB102, NAGB102R, NAGV071, NAGV071R, NAGV072, NAGV072R, NAGV101, NAGV101R, NAGV102, NAGV102R, SAEB071, SAEB071R, SAEB072, SAEB072R, SAEB101, SAEB101R, SAEB102, SAEB102R, SAEV071, SAEV071R...(Other models you can see in the webshop)		

			
<b>GEV No.</b>	542099	<b>Ref. No.</b>	62200131 LA62200131 LAR62200131
<b>description</b>	hose reel complete with spray gun hose length 1.6m connection John Guest 10mm hose ø 6x12mm		
<b>For models:</b>	CME061X, CVE061X, CVG061X, HME061X, HME101X, HME102X, HMG061P, HMG061T, HMG061X, HMG101X, HMG102X, HVE061X, HVE101X, HVE102X, HVG061P, HVG061T, HVG061X, HVG101X, HVG102X, KME061X, KME072X, KME081X, KME101X, KME102X, KMEA20X, KMG072X, KMG081X, KMG101X, KMG102X, KMGA20X, KVE061X, KVE072X, KVE081X, KVE101X, KVE102X, KVEA20X, KVG061X, KVG072X, KVG081X, KVG101X, KVG102X, KVGA20X, ME061H, ME061P, ME061T, ME101H, ME101P, ME101T, ME102H, ME102P...(Other models you can see in the webshop)		
<b>accessories for</b>	542099		
	<b>GEV No.</b>	542098	<b>Ref. No.</b> LA62200133
spray gun for appliances 3/8" IT L 130mm type LAINOX			

## dosing pumps

### membrane dosing pumps

#### self-priming

#### LANG

#### accessories

			
<b>GEV No.</b>	101286	<b>Ref. No.</b>	62070023 LA62070023 LAR62070023
<b>description</b>	olive ID ø 6mm Qty 1 pcs		
<b>For models:</b>	AREN064, AREN084, AREN154, ARES154, ARGN064, ARGN084, ARGN154, ARGS064, ARGS084, ARGS154, CBEN061, CBES061, CKES10, CME061S, CME061X, CVE061S, CVE061X, CVEN061, CVES061, CVG061S, CVG061X, GEMT07S, GEMT07X, GEMT10S, GEMT10X, GEMT20S, GEMT20X, GEMT21S, GEMT21X, GEMT40S, GEMT40X, GEVT07S, GEVT07X, GEVT10S, GEVT10X, GEVT20S, GEVT20X, GEVT21S, GEVT21X, GEVT40S, GEVT40X, GGMT07S, GGMT07X, GGMT10S, GGMT10X, GGMT20S, GGMT20X, GGMT21S, GGMT21X, GGMT40S...(Other models you can see in the webshop)		
<b>accessories for</b>	101286		
	<b>GEV No.</b>	100909	<b>Ref. No.</b> 62060223 LA62060223 LAR62060223 R62060223
union screw thread M10x1 for pipe ø 6mm Qty 1 pcs			
	<b>GEV No.</b>	101464	<b>Ref. No.</b> —
union nut thread M12x1 for pipe ø 6mm			

### accessories

#### container filters with non-return valve

			
<b>GEV No.</b>	361058	<b>Ref. No.</b>	65110650 LA65110650 LAR65110650
<b>description</b>	container filter with non-return valve SS hose ø 4x6mm ø 20mm L 56mm		
<b>For models:</b>	ABE084S, ABE104S, ABE156X, ABG084X, ABG104X, ABG156S, AREN154, ARES154, ARGN154, ARGS154, CEV026S, CEV026X, CEV061S, CEV061X, CEV101S, CEV101X, CKES10, CME061S, CME061X, CVE024S, CVE024X, CVE061S, CVE061X, CVG061S, CVG061X, EMT20P, EMT21P, EPE056T, EPE086T, EPE156T, EPEV05T, EPEV08T, EPEV15T, EPG056T, EPG086T, EPG156T, EPGV05T, EPGV08T, EPGV15T, EVEA20S, GEMT06P, GEMT06T, GEMT07S, GEMT07X, GEMT10P, GEMT10S, GEMT10T, GEMT10X, GEMT20P, GEMT20S...(Other models you can see in the webshop)		



## hoses

### pre-rinse hoses

#### stainless steel flexi hoses



<b>GEV No.</b>	542404	<b>Ref. No.</b>	62200058 LAR62200058
<b>description</b>	shower hose connections 1/2" L 2500mm unbraided nominal-ø DN8mm		
<b>For models:</b>	GEMT07S, GEMT07X, GEMT10S, GEMT10X, GEMT20S, GEMT20X, GEMT21S, GEMT21X, GEMT40S, GEMT40X, GEVT07S, GEVT07X, GEVT10S, GEVT10X, GEVT20S, GEVT20X, GEVT21S, GEVT21X, GEVT40S, GEVT40X, GGMT07S, GGMT07X, GGMT10S, GGMT10X, GGMT20S, GGMT20X, GGMT21S, GGMT21X, GGMT40S, GGMT40X, GGVT07S, GGVT07X, GGVT10S, GGVT10X, GGVT20S, GGVT20X, GGVT21S, GGVT21X, GGVT40S, GGVT40X, HME201X, HME202X, HMG201X, HMG202X, HVE201X, HVE202X, HVG201X, HVG202X, KME201S, KME201X...(Other models you can see in the webshop)		

<b>accessories for</b>	520973			
	<b>GEV No.</b>	440639	<b>Ref. No.</b>	—
	push-in fitting John Guest angled thread 1/4" BSP pipe connection ø10mm			
	<b>GEV No.</b>	520359	<b>Ref. No.</b>	62090528 LA62090528 LAR62090528 R62090528
	push-in fitting John Guest angled pipe connection ø10mm grommet ø 10mm			
	<b>GEV No.</b>	520363	<b>Ref. No.</b>	62090468 LA62090468 LAR62090468 R62090468
	push-in fitting John Guest T-piece pipe connection ø10mm - ø10mm - ø10mm			
	<b>GEV No.</b>	520494	<b>Ref. No.</b>	62090478 LA62090478 LAR62090478 R62090478
	push-in fitting John Guest angled pipe connection ø10mm - ø10mm			

### industrial hoses

#### Niplaflex hoses



<b>GEV No.</b>	530561	<b>Ref. No.</b>	70070010 LAR70070010
<b>description</b>	pressure hose ID ø 10mm ED ø 17mm L 5m thickness 3.5mm operating p. 10bar burst p. 30bar t.max. 110°C		

### PU hoses



<b>GEV No.</b>	512505	<b>Ref. No.</b>	80150020 LA80150020 LAR80150020
<b>description</b>	PU hose ID ø 5mm ED ø 8mm L 1m thickness 1.5mm t.max. -40 up to +60°C polyurethane transparent/colourless		
<b>For models:</b>	AREN064, AREN084, AREN154, ARES064, ARES084, ARES154, ARGN064, ARGN084, ARGN154, ARGS064, ARGS084, ARGS154, CBEN061, CBES061, CEV026S, CEV026X, CEV061S, CEV061X, CEV101S, CEV101X, CME061S, CME061X, CVE024S, CVE024X, CVE061S, CVE061X, CVEN061, CVES061, CVG061S, CVG061X, CVGN061, CVGS061, GEMT07S, GEMT07X, GEMT10S, GEMT10X, GEMT20S, GEMT20X, GEMT21S, GEMT21X, GEMT40S, GEMT40X, GEVT07S, GEVT07X, GEVT10S, GEVT10X, GEVT20S, GEVT20X, GEVT21S, GEVT21X...(Other models you can see in the webshop)		

### PE hoses



<b>GEV No.</b>	520973	<b>Ref. No.</b>	70070040 LA80150000 LAR70070040 LAR80150000 R70070050
----------------	--------	-----------------	---

<b>description</b>	hose John Guest thickness 1.5mm LLDPE blue ID ø 7mm ED ø 10mm		
<b>For models:</b>	ABE084S, ABE104S, ABE156X, ABG064M, ABG074M, ABG084X, ABG104X, ABG156S, AME07D, AME07P, AME10D, AREN064, AREN084, AREN154, ARES064, ARES084, ARES154, ARGN064, ARGN084, ARGN154, ARGS064, ARGS084, ARGS154, BPE064M, BPE064P, BPE074M, BPE074P, BPE084M, BPE084P, BPE104M, BPE104P, BPG064M, BPG064P, BPG074M, BPG074P, BPG084M, BPG084P, BPG104M, BPG104P, CEV026S, CEV026X, CEV061S, CEV061X, CEV101S, CEV101X, CME061S, CME061X, CVE024S, CVE024X, CVE061S...(Other models you can see in the webshop)		

### PVC hoses

#### PVC hoses without fabric



<b>GEV No.</b>	520278	<b>Ref. No.</b>	70070100 LAR70070100
----------------	--------	-----------------	-------------------------

<b>description</b>	PVC hose ID ø 6mm ED ø 8mm L 2m thickness 1mm t.max. 60°C transparent		
<b>For models:</b>	ABE084S, ABE104S, ABE156X, ABG084X, ABG104X, ABG156S, EMT20P, EMT21P, EPE056T, EPE086T, EPE156T, EPEV05T, EPEV08T, EPEV15T, EPG056T, EPG086T, EPG156T, EPGV05T, EPGV08T, EPGV15T, EVEA20S, GEMT06P, GEMT06T, GEMT10P, GEMT10T, GEMT20P, GEMT20T, GEMT21P, GEMT21T, GEMT40P, GEMT40T, GEVT06P, GEVT06S, GEVT06T, GEVT10P, GEVT10T, GEVT20P, GEVT20T, GEVT20X, GEVT21P, GEVT21T, GEVT40P, GEVT40T, GGMT06P, GGMT06T, GGMT10P, GGMT10T, GGMT20P, GGMT20T, GGMT21P...(Other models you can see in the webshop)		

<b>accessories for</b>	520973			
	<b>GEV No.</b>	440564	<b>Ref. No.</b>	—
	push-in fitting John Guest straight thread 1/4" BSP pipe connection ø10mm			
	<b>GEV No.</b>	440565	<b>Ref. No.</b>	—
	push-in fitting John Guest straight thread 3/8" BSP pipe connection ø10mm			
	<b>GEV No.</b>	440608	<b>Ref. No.</b>	—
	push-in fitting John Guest straight thread 1/2" BSP stub ø 10mm			



**silicone hoses**
**without fabric**

<b>GEV No.</b>	530899	<b>Ref. No.</b>	70060080 LAR70060080
<b>description</b>	silicone hose ID ø 13mm ED ø 18mm L 0.08m thickness 2.5mm red for combi-steamer		
<b>For models:</b>	ABE156X, ABG156S, AME07D, AME07P, AME10D, AREN064, AREN084, AREN154, ARES064, ARES084, ARES154, ARGN064, ARGN084, ARGN154, ARGS064, ARGS084, ARGS154, AVE07D, AVE07P, AVE10D, AVE10P, AVG05P, AVG10D, AVG20D, CBEN061, CBES061, CEC40M, CES24M, CES40M, CEV026S, CEV026X, CEV061S, CEV061X, CEV101S, CEV101X, CGC24M, CGC40M, CGS24M, CGS40M, CKES10, CME061S, CME061X, COEN026, COEN061, COEN101, COES026, COES061, COES101, CVE061S, CVE061X...(Other models you can see in the webshop)		



<b>GEV No.</b>	530884	<b>Ref. No.</b>	70060060 70060070 LAR70060060 LAR70060070
<b>description</b>	silicone hose ID ø 15mm ED ø 19mm L 0.08m thickness 3mm red for combi-steamer		
<b>For models:</b>	CG105M, CVE004H, CVE004M, CVE104H, CVE104M, CVE105H, CVE105M, CVG105H, CVG105M, EM006H, EM006M+SC, EM010H, EM010M+SC, EM020M, EM106H, EM106M, EM106M+SC, EM106P, EM110H, EM110M, EM110M+SC, EM110P, EM210H, EM210M, EM210M+SC, EM210P, FME101AX, FME201SX, FME61A, FME61S, FMG201A, FMG201S, GM020H, GM020M, GM106H, GM106M, GM106M+SC, GM106P, GM110H, GM110M, GM110M+SC, GM110P, GM210H, GM210M, GM210M+SC, GM210P, ME004L, ME004S, ME104L, ME104S...(Other models you can see in the webshop)		

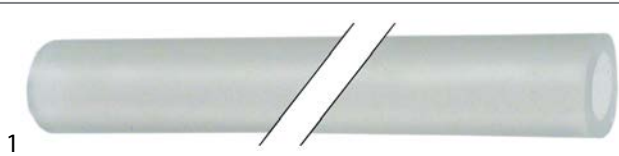

<b>GEV No.</b>	570157	<b>Ref. No.</b>	80120060 LA80120060 LAR70070090 LAR80120060
<b>description</b>	silicone hose ID ø 7mm ED ø 12mm L 1m thickness 2.5mm transparent for combi-steamer		
<b>For models:</b>	ABE084S, ABE104S, ABE156X, ABG084X, ABG104X, ABG156S, AREN064, AREN084, AREN154, ARES064, ARES084, ARES154, ARGN064, ARGN084, ARGN154, ARGS064, ARGS084, ARGS154, EVEA20S, GEMT07S, GEMT07X, GEMT10S, GEMT10X, GEMT20S, GEMT20X, GEMT21S, GEMT21X, GEMT40S, GEMT40X, GEVT06S, GEVT07S, GEVT07X, GEVT10S, GEVT10X, GEVT20S, GEVT20X, GEVT21S, GEVT21X, GEVT40S, GEVT40X, GGMT07S, GGMT07X, GGMT10S, GGMT10X, GGMT20S, GGMT20X, GGMT21S, GGMT21X, GGMT40S, GGMT40X...(Other models you can see in the webshop)		

**formed hoses**
**straight**

<b>GEV No.</b>	520534	<b>Ref. No.</b>	70060040 LA70060040 LAR70060040
<b>description</b>	hose ID ø 50mm ED ø 58mm L 50mm silicone Qty 1 for combi-steamer thickness 4mm		
<b>For models:</b>	ABE084S, ABE104S, ABE156X, ABG084X, ABG104X, ABG156S, AREN064, AREN084, AREN154, ARES064, ARES084, ARES154, ARGN064, ARGN084, ARGN154, ARGS064, ARGS084, ARGS154, CE106M, CE110M, CE210M, CG106M, CG110M, CG210M, CKES10, EMT21P, EPE056T, EPE086T, EPE156T, EPEV05T, EPEV08T, EPEV15T, EPG056T, EPG086T, EPG156T, EPGV05T, EPGV08T, EPGV15T, FE051M, FE051X, FE101M, FE101X, FE105M, FE105X, FE110M, FE110X, FE1102P, FG051M, FG051X, FG101M...(Other models you can see in the webshop)		



<b>GEV No.</b>	530901	<b>Ref. No.</b>	70060050 LA70060050 R70060050
<b>description</b>	hose ID ø 54mm ED ø 60mm L 50mm for combi-steamer		
<b>For models:</b>	FE102M, FE102X, FE210M, FE210X, FG102M, FG102X, FG210M, FG210X, GEMT20P, GEMT20S, GEMT20T, GEMT20X, GEMT40P, GEMT40S, GEMT40T, GEMT40X, GEVT20P, GEVT20S, GEVT20T, GEVT20X, GEVT40P, GEVT40S, GEVT40T, GEVT40X, GGMT20S, GGMT20X, GGMT40P, GGMT40S, GGMT40T, GGMT40X, GGV20S, GGV20X, GGV20P, GGV20S, GGV20T, GGV20X, HME102P, HME102S, HME102T, HME102X, HME202P, HME202S, HME202T, HME202X, HMG202P, HMG202T, HMG202X, HVE102P, HVE102S, HVE102T...(Other models you can see in the webshop)		



<b>GEV No.</b>	694499	<b>Ref. No.</b>	70070060 LAR70070060 R70070070
<b>description</b>	hose ID ø 7mm L 2000mm LLDPE for beverage technology ED ø 10mm John Guest		
<b>For models:</b>	ACE10M, ACG10M, APE06, APE07, APG08M, APG10M, AVE07D, AVE07P, AVE10D, AVE10P, AVG10D, AVG20D, CE071M, CE100M, CE200M, CG071M, CG100M, CG200M, EMT06D, EVT06D, EVT20D, GVT20D, MACE07M, MACE10M, MACE20M, MACG07M, MACG10M, MACG20M, ME061D, ME061T, ME101T, ME102T, MEMT06D, MEVT06D, MEVT20D, MEVT20P, MG061T, MG101T, MG102T, MGVT20D, MGVT20P, PE064M, PE064P, PE074M, PE074P, PE084M, PE084P, PE104M, PE104P, PEV08T...(Other models you can see in the webshop)		





			
<b>GEV No.</b>	592327	<b>Ref. No.</b>	80150060 LA80150060 LAR80150060
<b>description</b>	water hose ID ø 7mm ext. ø 10 L 1000mm operating p. 3bar temp.-resist. 92°C for combi-steamer		
<b>For models:</b>	AREN064, AREN084, AREN154, ARES064, ARES084, ARES154, ARGN064, ARGN084, ARGN154, ARGS064, ARGS084, ARGS154, GEMT07S, GEMT07X, GEMT10S, GEMT10X, GEMT20S, GEMT20X, GEMT40S, GEMT40X, GEVT07S, GEVT07X, GEVT10S, GEVT10X, GEVT20S, GEVT20X, GEVT21S, GEVT21X, GEVT40S, GEVT40X, GGMT07S, GGMT07X, GGMT10S, GGMT10X, GGMT20S, GGMT20X, GGMT21X, GGMT40S, GGMT40X, GGVT07S, GGVT07X, GGVT10S, GGVT10X, GGVT20S, GGVT20X, GGVT21S, GGVT21X, GGVT40S, GGVT40X, LBES071...(Other models you can see in the webshop)		

hose connectors

plastic

			
<b>GEV No.</b>	362015	<b>Ref. No.</b>	LAR62090638
<b>description</b>	hose connector plastic straight IT 1/4" hose ø 8mm		
<b>For models:</b>	AREN154, ARES154, ARGN154, ARGS154, CEV026S, CEV026X, CEV061S, CEV061X, CEV101S, CEV101X, CKES10, CME061S, CME061X, CVE024S, CVE024X, CVE061S, CVE061X, CVG061S, CVG061X, GEMT07S, GEMT07X, GEMT10S, GEMT10X, GEMT20S, GEMT20X, GEMT21S, GEMT21X, GEMT40S, GEMT40X, GEVT07S, GEVT07X, GEVT10S, GEVT10X, GEVT20S, GEVT20X, GEVT21S, GEVT21X, GEVT40S, GEVT40X, GGMT07S, GGMT07X, GGMT10S, GGMT10X, GGMT20S, GGMT20X, GGMT21S, GGMT21X, GGMT40S, GGMT40X, GGVT07S...(Other models you can see in the webshop)		

fittings, hose and pipe connectors

fittings

double nipples

			
<b>GEV No.</b>	521182	<b>Ref. No.</b>	62020118 LA62020118 LAR62020118
<b>description</b>	double nipple plastic thread 1/4" - 1/4" Qty 1 pcs		
<b>For models:</b>	AREN154, ARES154, ARGN154, ARGS154, GEMT07S, GEMT07X, GEMT10S, GEMT10X, GEMT20S, GEMT20X, GEMT21S, GEMT21X, GEMT40S, GEMT40X, GEVT07S, GEVT07X, GEVT10S, GEVT10X, GEVT20S, GEVT20X, GEVT21S, GEVT21X, GEVT40S, GEVT40X, GGMT07S, GGMT07X, GGMT10S, GGMT10X, GGMT20S, GGMT20X, GGMT21S, GGMT21X, GGMT40S, GGMT40X, GGVT07S, GGVT07X, GGVT10S, GGVT10X, GGVT20S, GGVT20X, GGVT21S, GGVT21X, GGVT40S, GGVT40X, KME081S, KME081X, KME101S, KME101X, KME-A20S, KMEA20X...(Other models you can see in the webshop)		

			
<b>GEV No.</b>	362010	<b>Ref. No.</b>	62090492 LAR62090492
<b>description</b>	hose connector plastic straight thread 1/4" hose ø 8mm Qty 1 pcs		
<b>For models:</b>	EMT20P, EMT21P, EPE056T, EPE086T, EPE156T, EPEV05T, EPEV08T, EPEV15T, EPG056T, EPG086T, EPG156T, EPGV05T, EPGV08T, EPGV15T, GEMT06P, GEMT06T, GEMT10P, GEMT10T, GEMT20P, GEMT20T, GEMT21P, GEMT21T, GEMT40P, GEMT40T, GEVT06P, GEVT06T, GEVT10P, GEVT10T, GEVT20P, GEVT20T, GEVT21P, GEVT21T, GEVT40P, GEVT40T, GGMT06P, GGMT06T, GGMT10P, GGMT10T, GGMT20P, GGMT20T, GGMT21P, GGMT21T, GGMT40P, GGMT40T, GGVT06P, GGVT06T, GGVT10P, GGVT10T, GGVT20P, GGVT20T...(Other models you can see in the webshop)		

screw pipe fittings

angle pieces

			
<b>GEV No.</b>	699452	<b>Ref. No.</b>	62090633 LA62090633 LAR62090633
<b>description</b>	angle piece thread M14x1 tube ø 10mm brass		
<b>For models:</b>	ABE084S, ABE104S, ABE156X, ABG084X, ABG104X, ABG156S, AREN064, AREN084, AREN154, ARES064, ARES084, ARES154, ARGN064, ARGN084, ARGN154, ARGS064, ARGS084, ARGS154, CEV026S, CEV026X, CEV061S, CEV061X, CEV101S, CEV101X, CKES10, CME061S, CME061X, CME061X, CME061X, CME061S, CME061X, CVG061S, CVG061X, EPEV05T, EPEV08T, EPEV15T, EPGV05T, EPGV08T, EPGV15T, EVEA20S, GEMT07S, GEMT07X, GEMT10S, GEMT10X, GEMT20S, GEMT20X, GEMT21S, GEMT21X, GEMT40S, GEMT40X...(Other models you can see in the webshop)		

			
<b>GEV No.</b>	362011	<b>Ref. No.</b>	62090538 LA62090538 LAR62090538
<b>description</b>	hose connector plastic straight thread 1/4" hose ø 8x6mm Qty 1 pcs		
<b>For models:</b>	ABE084S, ABE104S, ABE156X, ABG084X, ABG104X, ABG156S, CEV061S, CEV061X, CKES10, CME061X, CME061X, CME061S, EMT20P, EMT21P, EPE056T, EPE086T, EPE156T, EPEV05T, EPEV08T, EPEV15T, EPG056T, EPG086T, EPG156T, EPGV05T, EPGV08T, EPGV15T, EVEA20S, GEMT06P, GEMT06T, GEMT10P, GEMT10T, GEMT20P, GEMT20T, GEMT21P, GEMT21T, GEMT40P, GEMT40T, GEVT06P, GEVT06S, GEVT06T, GEVT10P, GEVT10S, GEVT10T, GEVT20P, GEVT20T, GEVT20X, GEVT21P, GEVT21S, GEVT21T...(Other models you can see in the webshop)		

			
<b>GEV No.</b>	362016	<b>Ref. No.</b>	62090658 LAR62090658
<b>description</b>	hose connector plastic straight thread 1/8" hose ø 8x6mm		
<b>For models:</b>	EPE056T, EPE086T, EPE156T, EPEV05T, EPEV08T, EPEV15T, EPG056T, EPG086T, EPG156T, EPGV05T, EPGV08T, EPGV15T, GEMT06P, GEMT06T, GEMT10P, GEMT10T, GEMT20P, GEMT20T, GEMT21P, GEMT21T, GEMT40P, GEMT40T, GEVT06P, GEVT06T, GEVT10P, GEVT10T, GEVT20P, GEVT20T, GEVT21P, GEVT21T, GEVT40P, GEVT40T, GGMT06P, GGMT06T, GGMT10P, GGMT10T, GGMT20P, GGMT20T, GGMT21P, GGMT21T, GGMT40P, GGMT40T, GGVT06P, GGVT06T, GGVT10P, GGVT10T, GGVT20P, GGVT20T, GGVT21P, GGVT21T...(Other models you can see in the webshop)		



stainless steel



<b>GEV No.</b>	542385	<b>Ref. No.</b>	62090663 LA62090663 LAR62090663
<b>description</b>	hose connector SS angled thread 1/4" hose ø 10mm Qty 1 pcs		
<b>For models:</b>	AREN064, AREN084, AREN154, ARES064, ARES084, ARES154, ARGNO64, ARGNO84, ARGN154, ARGS064, ARGS084, ARGS154, CEV026S, CEV026X, CEV061S, CEV061X, CEV101S, CEV101X, CME061S, CME061X, CVE024S, CVE024X, CVE061S, CVE061X, CVG061S, CVG061X, GEMT07S, GEMT07X, GEMT10S, GEMT10X, GEMT20S, GEMT20X, GEMT21S, GEMT21X, GEMT40S, GEMT40X, GEVT07S, GEVT07X, GEVT10S, GEVT10X, GEVT20S, GEVT20X, GEVT21S, GEVT21X, GEVT40S, GEVT40X, GGMT07S, GGMT07X, GGMT10S, GGMT10X...(Other models you can see in the webshop)		

producer-specific



<b>GEV No.</b>	440027	<b>Ref. No.</b>	62090482 LA62090482 LAR62090482
<b>description</b>	connecting piece for hose ID 6mm WS 15 total length 79mm plastic John Guest		
<b>For models:</b>	ABE084S, ABE104S, ABE156X, ABG084X, ABG104X, ABG156S, AREN154, ARES154, ARGN154, ARGS154, CEV026S, CEV026X, CEV061S, CEV061X, CEV101S, CEV101X, CKES10, CME061S, CME061X, CVE024S, CVE024X, CVE061S, CVE061X, CVG061S, CVG061X, EMT20P, EMT21P, EPE056T, EPE086T, EPE156T, EPEV05T, EPEV08T, EPEV15T, EPG056T, EPG086T, EPG156T, EPGV05T, EPGV08T, EPGV15T, EVEA20S, GEMT06P, GEMT06T, GEMT07S, GEMT07X, GEMT10P, GEMT10S, GEMT10T, GEMT10X, GEMT20P, GEMT20S...(Other models you can see in the webshop)		



<b>GEV No.</b>	520339	<b>Ref. No.</b>	62090518 LA62090518 LAR62090518
<b>description</b>	hose connector thread 1/4" straight grommet ø 10mm grommet length 20mm WS 20 total length 37mm thread L 11mm plastic		
<b>For models:</b>	ABE084S, ABE104S, ABE156X, ABG156S, AREN064, AREN084, ARES064, ARES084, ARGNO64, ARGNO84, ARGS064, ARGS084, AVG10D, AVG20D, CBEN061, CBES061, COEN026, COEN061, COEN101, COES026, COES061, COES101, CVEN061, CVES061, CVGN061, CVGS061, EMT20P, EMT21P, EPE056T, EPE086T, EPE156T, EPEV05T, EPEV08T, EPEV15T, EPG056T, EPG086T, EPG156T, EPGV05T, EPGV08T, EPGV15T, EVEA20S, GEMT06P, GEMT06T, GEMT10P, GEMT10T, GEMT20P, GEMT20T, GEMT21P, GEMT21T, GEMT40P...(Other models you can see in the webshop)		



<b>GEV No.</b>	520360	<b>Ref. No.</b>	62090508 LAR62090508
<b>description</b>	hose connector thread 1/4" with coupling straight plastic		
<b>For models:</b>	ABE084S, ABE104S, ABE156X, ABG084X, ABG104X, ABG156S, AREN064, AREN084, ARES064, ARES084, ARGNO64, ARGNO84, ARGS064, ARGS084, AVE07D, AVE07P, AVE10D, AVE10P, AVG05P, BPE044P, BPE054P, BPE064M, BPE064P, BPE074M, BPE074P, BPE084M, BPE084P, BPE104M, BPE104P, BPG044P, BPG054P, BPG064M, BPG064P, BPG074M, BPG074P, BPG084M, BPG084P, BPG104M, BPG104P, CEV026S, CEV026X, CEV061S, CEV061X, CEV101S, CEV101X, CME061S, CME061X, CVE024S, CVE024X, CVE061S...(Other models you can see in the webshop)		



push-in fittings

JOHN GUEST



<b>GEV No.</b>	440019	<b>Ref. No.</b>	62090548 LA62090548 LAR62090548
<b>description</b>	push-in fitting John Guest straight pipe connection ø6mm grommet ø 10mm		
<b>For models:</b>	EMT20P, EMT21P, EPE056T, EPE086T, EPE156T, EPEV05T, EPEV08T, EPEV15T, EPG056T, EPG086T, EPG156T, EPGV05T, EPGV08T, EPGV15T, GEMT06P, GEMT06T, GEMT10P, GEMT10T, GEMT20P, GEMT20T, GEMT21P, GEMT21T, GEMT40P, GEMT40T, GEVT06P, GEVT06T, GEVT10P, GEVT10T, GEVT20P, GEVT20T, GEVT21P, GEVT21T, GEVT40P, GEVT40T, GGMT06P, GGMT06T, GGMT10P, GGMT10T, GGMT20P, GGMT20T, GGMT21P, GGMT21T, GGMT40P, GGMT40T, GGVT06P, GGVT06T, GGVT10P, GGVT10T, GGVT20P, GGVT20T...(Other models you can see in the webshop)		
<b>accessories for</b>	440019		
	<b>GEV No.</b>	520971	<b>Ref. No.</b> —
	hose thickness 1mm LLDPE blue ID ø 4mm ED ø 6mm operating pressure at 20°C 16bar		



			
<b>GEV No.</b>	520359	<b>Ref. No.</b>	62090528 LA62090528 LAR62090528
<b>description</b>	push-in fitting John Guest angled pipe connection ø10mm grommet ø 10mm		
<b>For models:</b>	ABE084S, ABE104S, ABE156X, ABG084X, ABG104X, ABG156S, AREN064, AREN084, AREN154, ARES064, ARES084, ARES154, ARGN064, ARGN084, ARGN154, ARGS064, ARGS084, ARGS154, CBES061, CEV026S, CEV026X, CEV061S, CEV061X, CEV101S, CEV101X, CKES10, CME061S, CME061X, COEN026, COEN061, COEN101, COES026, COES061, COES101, CVE024S, CVE024X, CVE061S, CVE061X, CVES061, CVG061S, CVG061X, CVGS061, EMT20P, EMT21P, EPE056T, EPE086T, EPE156T, EPEV05T, EPEV08T, EPEV15T...(Other models you can see in the webshop)		
<b>accessories for</b>	520359		
			
<b>GEV No.</b>	520973	<b>Ref. No.</b>	70070040 LA80150000 LAR70070040 LAR80150000 R70070040 R70070050 R80150000
hose John Guest thickness 1.5mm LLDPE blue ID ø 7mm ED ø 10mm			

			
<b>GEV No.</b>	440671	<b>Ref. No.</b>	62090648 62090678 LA62090678 LAR62090648 LAR62090678
<b>description</b>	push-in fitting John Guest angled pipe connection ø8mm grommet ø 8mm		
<b>For models:</b>	ABE084S, ABE104S, ABE156X, ABG084X, ABG104X, ABG156S, AREN064, AREN084, AREN154, ARES064, ARES084, ARES154, ARGN064, ARGN084, ARGN154, ARGS064, ARGS084, ARGS154, CEV026S, CEV026X, CEV061S, CEV061X, CEV101S, CEV101X, CME061S, CME061X, CVE024S, CVE024X, CVE061S, CVE061X, CVG061S, CVG061X, EPE056T, EPE086T, EPE156T, EPEV05T, EPEV08T, EPEV15T, EPG056T, EPG086T, EPG156T, EPGV05T, EPGV08T, EPGV15T, EVEA20S, GEMT06P, GEMT06T, GEMT07S, GEMT07X, GEMT10P...(Other models you can see in the webshop)		
<b>accessories for</b>	440671		
			
<b>GEV No.</b>	520972	<b>Ref. No.</b>	—
hose John Guest thickness 1mm LLDPE blue ID ø 6mm ED ø 8mm			

			
<b>GEV No.</b>	440021	<b>Ref. No.</b>	62090808 LA62090808
<b>description</b>	push-in fitting John Guest angled pipe connection ø6mm grommet ø 6mm		
<b>For models:</b>	CME061S, CME061X, GEMT07S, GEMT07X, GEMT10S, GEMT10X, GEMT20S, GEMT20X, GEMT21S, GEMT21X, GEMT40S, GEMT40X, GGMT07S, GGMT07X, GGMT10S, GGMT10X, GGMT20S, GGMT20X, GGMT21S, GGMT21X, GGMT40S, GGMT40X, KME061S, KME061X, KME072S, KME072X, KME081S, KME081X, KME101S, KME101X, KME102X, KME201S, KME201X, KME202S, KME202X, KMEA20S, KMEA20X, KMG072S, KMG072X, KMG081S, KMG081X, KMG101S, KMG101X, KMG102S, KMG102X, KMG201S, KMG201X, KMG202S, KMG202X, KMG20S...(Other models you can see in the webshop)		
<b>accessories for</b>	440021		
			
<b>GEV No.</b>	520971	<b>Ref. No.</b>	—
hose thickness 1mm LLDPE blue ID ø 4mm ED ø 6mm operating pressure at 20°C 16bar			

			
<b>GEV No.</b>	520493	<b>Ref. No.</b>	62090618 LA62090618 LAR62090618
<b>description</b>	hose connector John Guest straight pipe connection ø8mm - ø10mm L 41mm PM201008E NSF, SK		
<b>For models:</b>	ABE084S, ABE104S, ABE156X, ABG084X, ABG104X, ABG156S, AREN064, AREN084, AREN154, ARES064, ARES084, ARES154, ARGN064, ARGN084, ARGN154, ARGS064, ARGS084, ARGS154, CEV026S, CEV026X, CEV061S, CEV061X, CEV101S, CEV101X, CKES10, CME061S, CME061X, CVE024S, CVE024X, CVE061S, CVE061X, CVG061S, CVG061X, EMT20P, EMT21P, EPE056T, EPE086T, EPEV05T, EPEV08T, EPG056T, EPG086T, EPGV05T, EPGV08T, EVEA20S, GEMT06P, GEMT06T, GEMT10P, GEMT10T, GEMT20P, GEMT20T...(Other models you can see in the webshop)		

			
<b>GEV No.</b>	520492	<b>Ref. No.</b>	62090458 LA62090458 LAR62090458
<b>description</b>	push-in fitting John Guest straight pipe connection ø10mm - ø10mm		
<b>For models:</b>	ABE044M, ABE054M, ABE084S, ABE104S, ABE156X, ABG084X, ABG104X, ABG156S, ACE04M, ACE05M, AME07D, AME07P, AME10D, AVE07D, AVE07P, AVE10D, AVE10P, AVG05P, AVG10D, AVG20D, BPE044M, BPE044P, BPE054M, BPE054P, BPE064M, BPE064P, BPE074M, BPE074P, BPE084M, BPE084P, BPE104M, BPE104P, BPG044M, BPG044P, BPG054M, BPG054P, BPG064M, BPG064P, BPG074M, BPG074P, BPG084M, BPG084P, BPG104M, BPG104P, CE041M, CE051M, CEV026S, CEV026X, CEV061S, CEV061X...(Other models you can see in the webshop)		





1

<b>GEV No.</b>	440647	<b>Ref. No.</b>	62090798
<b>description</b>	push-in fitting John Guest straight pipe connection $\phi 6\text{mm} - \phi 8\text{mm}$		





1

<b>GEV No.</b>	520961	<b>Ref. No.</b>	62090788 LA62090788 LAR62090788
<b>description</b>	push-in fitting pipe connection $\phi 6\text{mm} - \phi 10\text{mm}$		
<b>For models:</b>	ICET041, REC023M, REC051M, REC071M, REP044S, REP054M, REP054S, REV051M, REV051S, REV071M, REV071S, REV101M, REV101S, RGC101M		





1

<b>GEV No.</b>	520494	<b>Ref. No.</b>	62090478 LA62090478 LAR62090478
<b>description</b>	push-in fitting John Guest angled pipe connection $\phi 10\text{mm} - \phi 10\text{mm}$		
<b>For models:</b>	ABE044M, ABE054M, ABE084S, ABE104S, ABE156X, ABG064M, ABG074M, ABG084X, ABG104X, ABG156S, ACE04M, ACE05M, ACE10M, ACG10M, AME07D, AME07P, AME10D, APE06, APE07, APG08M, APG10M, AREN064, AREN084, AREN154, ARES064, ARES084, ARES154, ARGN064, ARGN084, ARGN154, ARGS064, ARGS084, ARGS154, AVE07D, AVE07P, AVE10D, AVE10P, AVG05P, AVG10D, AVG20D, BPE044M, BPE044P, BPE054M, BPE054P, BPE064M, BPE064P, BPE074M, BPE074P, BPE084M, BPE084P...(Other models you can see in the webshop)		
<b>accessories for</b>	520494		
	<b>GEV No.</b>	520973	<b>Ref. No.</b>
			70070040 LA80150000 LAR70070040 LAR80150000 R70070040 R70070050 R80150000
hose John Guest thickness 1.5mm LLDPE blue ID $\phi 7\text{mm}$ ED $\phi 10\text{mm}$			



1

<b>GEV No.</b>	520363	<b>Ref. No.</b>	62090468 LA62090468 LAR62090468
<b>description</b>	push-in fitting John Guest T-piece pipe connection $\phi 10\text{mm} - \phi 10\text{mm} - \phi 10\text{mm}$		
<b>For models:</b>	ABE084S, ABE104S, ABE156X, ABG084X, ABG104X, ABG156S, AREN064, AREN084, AREN154, ARES064, ARES084, ARES154, ARGN064, ARGN084, ARGN154, ARGS064, ARGS084, ARGS154, CEV026S, CEV026X, CEV061S, CEV061X, CEV101S, CEV101X, CKES10, CME061S, CME061X, CVE024S, CVE024X, CVE061S, CVE061X, CVG061S, CVG061X, EMT20P, EMT21P, EPE056T, EPE086T, EPE156T, EPEV05T, EPEV08T, EPEV15T, EPG056T, EPG086T, EPG156T, EPGV05T, EPGV08T, EPGV15T, EVEA20S, GEMT06P, GEMT06T...(Other models you can see in the webshop)		
<b>accessories for</b>	520363		
	<b>GEV No.</b>	520973	<b>Ref. No.</b>
			70070040 LA80150000 LAR70070040 LAR80150000 R70070040 R70070050 R80150000
hose John Guest thickness 1.5mm LLDPE blue ID $\phi 7\text{mm}$ ED $\phi 10\text{mm}$			



1

<b>GEV No.</b>	520495	<b>Ref. No.</b>	62090608 LA62090608 LAR62090608
<b>description</b>	push-in fitting John Guest straight thread 1/8" BSP stub $\phi 8\text{mm}$		
<b>For models:</b>	ABE084S, ABE104S, ABE156X, ABG084X, ABG104X, ABG156S, AREN154, ARES154, ARGN154, ARGS154, CBEN061, CBES061, CEV026S, CEV026X, CEV061S, CEV061X, CEV101S, CEV101X, CKES10, CME061S, CME061X, COEN026, COEN061, COEN101, COES026, COES061, COES101, CVE024S, CVE024X, CVE061S, CVE061X, CVEN061, CVES061, CVG061S, CVG061X, CVGN061, CVGS061, EMT20P, EMT21P, EPE056T, EPE086T, EPE156T, EPEV05T, EPEV08T, EPEV15T, EPG056T, EPG086T, EPG156T, EPGV05T, EPGV08T...(Other models you can see in the webshop)		
<b>accessories for</b>	520495		
	<b>GEV No.</b>	520971	<b>Ref. No.</b>
			—
hose thickness 1mm LLDPE blue ID $\phi 4\text{mm}$ ED $\phi 6\text{mm}$ operating pressure at 20°C 16bar			



			
1			
<b>GEV No.</b>	440031	<b>Ref. No.</b>	62090688 LA62090688 LAR62090688
<b>description</b>	push-in fitting John Guest straight thread 1/2" pipe connection ø8mm - ø8mm bulkhead connector		
<b>For models:</b>	AREN154, ARES154, ARGN154, ARG154, CEV026S, CEV026X, CEV061S, CEV061X, CEV101S, CEV101X, CME061S, CME061X, CVE024S, CVE024X, CVE061S, CVE061X, CVG061S, CVG061X, GEMT07S, GEMT07X, GEMT10S, GEMT10X, GEMT20S, GEMT20X, GEMT21S, GEMT21X, GEMT40S, GEMT40X, GEVT07S, GEVT07X, GEVT10S, GEVT10X, GEVT20S, GEVT20X, GEVT21S, GEVT21X, GEVT40S, GEVT40X, GGMT07S, GGMT07X, GGMT10S, GGMT10X, GGMT20S, GGMT20X, GGMT21S, GGMT21X, GGMT40S, GGMT40X, GGV07S, GGV07X...(Other models you can see in the webshop)		

			
1			
<b>GEV No.</b>	403042	<b>Ref. No.</b>	65110560 LAR65110560
<b>description</b>	ball valve inlet 3/4" IT outlet 3/4" IT 230V L 68mm closed off-current mode of operation electric connection cable 400mm		
<b>For models:</b>	AME07D, AME07P, AME10D, CBEN061, CBES061, CME061S, CME061X, EMT06D, EMT10D, EMT20P, EMT21P, GEMT06P, GEMT06T, GEMT10P, GEMT10T, GEMT20P, GEMT20T, GEMT21P, GEMT21T, GEMT40P, GEMT40T, GGMT06P, GGMT06T, GGMT10P, GGMT10T, GGMT20P, GGMT20T, GGMT21P, GGMT21T, GGMT40P, GGMT40T, GMT06D, GMT06P, GMT20D, GMT20P, GSE201N, HME061P, HME061T, HME061X, HME101P, HME101S, HME101T, HME101X, HME102P, HME102S, HME102T, HME102X, HME201P, HME201S, HME201T...(Other models you can see in the webshop)		

valves and tank inlets

ball valves

universal

ball valves with butterfly handle

			
1			
<b>GEV No.</b>	540658	<b>Ref. No.</b>	1450500
<b>description</b>	ball valve connection 3/4" IT - 3/4" IT DN20 total length 69mm		

ball valves electric

			
1			
<b>GEV No.</b>	403026 <sup>1</sup>	<b>Ref. No.</b>	65110540 LAR65110540
<b>description</b>	ball valve inlet 1/2" IT outlet 1/2" IT 230V L 90mm 50/60Hz off-current open mode of operation electric W 60mm H 100mm connection cable 450mm IT 1/2"		
<b>For models:</b>	EM006H, EM006M+SC, EM010H, EM010M+SC, EM020M, EM106H, EM106M, EM106M+SC, EM106P, EM110H, EM110M, EM110M+SC, EM110P, EM210H, EM210M, EM210M+SC, EM210P, GM020H, GM020M, GM106H, GM106M, GM106M+SC, GM106P, GM110H, GM110M, GM110M+SC, GM110P, GM210H, GM210M, GM210M+SC, GM210P, ME004L, ME004S, ME104L, ME104S, ME105L, ME105S, ME106D, ME106H, ME106L, ME106M, ME106P, ME106S, ME106T, ME106X, ME110D, ME110H, ME110L, ME110M, ME110P...(Other models you can see in the webshop)		

<sup>1</sup>off-current open

beverage technology

valves

non-return valves

			
1			
<b>GEV No.</b>	440727	<b>Ref. No.</b>	65110680 LA65110680 LAR65110680
<b>description</b>	non-return valve John Guest pipe connection ø10mm - ø10mm operating pressure at 20°C 10bar opening pressure 0.02bar POM		
<b>For models:</b>	ABG084X, ABG104X, AREN064, AREN084, AREN154, ARES064, ARES084, ARES154, ARGN064, ARGN084, ARGN154, ARG104, ARG154, ARG5084, ARG5154, CEV026S, CEV026X, CEV061S, CEV061X, CEV101S, CEV101X, CKES10, CME061S, CME061X, CVE024S, CVE024X, CVE061S, CVE061X, CVG061S, CVG061X, GEMT21S, GEMT21X, GEMT40S, GEMT40X, GEVT21S, GEVT21X, GEVT40S, GEVT40X, GGMT21S, GGMT21X, GGMT40S, GGMT40X, GGV21S, GGV21X, GGV40S, GGV40X, KME061S, KME061X, KME072S, KME072X, KME081S...(Other models you can see in the webshop)		

			
1			
<b>GEV No.</b>	440026	<b>Ref. No.</b>	62300018 LAR62300018
<b>description</b>	non-return valve kit John Guest pipe connection ø10x10mm operating pressure at 20°C 10bar opening pressure 0.02bar POM		
<b>For models:</b>	ME061T, ME101T, ME102T, ME201T, MG061T, MG101T, MG102T, MG201T, MG202T		





## ancillary products

### clamps

#### hose clamps

DIN 3017 - W2



1

<b>GEV No.</b>	520112	<b>Ref. No.</b>	61630011 LAR61630011
<b>description</b>	hose clamp ø 12-20mm width 9mm Qty 10 pcs DIN 3017		
<b>For models:</b>	ABE084S, ABE104S, ABE156X, ABG084X, ABG104X, ABG156S, AME07D, AME07P, AME10D, AREN084, AVE07D, AVE07P, AVE10D, AVE10P, AVG05P, AVG10D, AVG20D, CE106M, CE110M, CE210M, CEC40M, CES24M, CES40M, CEV061S, CEV061X, CG105M, CG106M, CG110M, CG210M, CGC24M, CGC40M, CGS24M, CGS40M, CKES10, CME061X, CVE004H, CVE004M, CVE024S, CVE061S, CVE104H, CVE104M, CVE105H, CVE105M, CVG105H, CVG105M, EC020M, EC106M, EC110M, EC210M, EM006H...(Other models you can see in the webshop)		



1

<b>GEV No.</b>	520454	<b>Ref. No.</b>	61630041
<b>description</b>	hose clamp ø 70-90mm width 9mm Qty 5 pcs DIN 3017		

## tools

### hand tools

#### pullers



1

<b>GEV No.</b>	801445	<b>Ref. No.</b>	R75401230
<b>description</b>	puller for fan wheel seat ø 33-40mm WS 24		

## measuring equipment

### thermometers

#### built-in thermometers

ø52mm



1

<b>GEV No.</b>	541077	<b>Ref. No.</b>	50304610 65340050 LA65340050 LAR50304610 LAR65340050
<b>description</b>	thermometer mounting ø 52mm t.max. 350°C +50 up to +350°C probe ø 6mm probe L 30mm capillary pipe 1000mm built-in depth 28mm		
<b>For models:</b>	CE106M, CE110M, CE210M, CEC40M, CES24M, CES40M, CG106M, CG110M, CG210M, CGC24M, CGC40M, CGS24M, CGS40M, EC020M, EC106M, EC110M, EC210M, EM006M+SC, EM010M+SC, EM020M, EM106M, EM106M+SC, EM110M, EM110M+SC, EM210M, EM210M+SC, EV006M, EV010M, EV020M, EV106M, EV106M+SC, EV110M, EV110M+SC, EV210M, EV210M+SC, FE05, FE051M, FE051X, FE101M, FE101X, FE102M, FE102X, FE105M, FE105X, FE110M, FE110X, FE210M, FE210X, FG05, FG051M...(Other models you can see in the webshop)		

## fastening material

### screws

#### raised countersunk head screws





1

<b>GEV No.</b>	560541	<b>Ref. No.</b>	61040272 LA61050102 LAR61040272
<b>description</b>	raised countersunk head screw thread M6 thread L 13mm SS DIN 966/ISO 7047 Qty 1 pcs intake slotted head ø 11mm head thickness 5mm		
<b>For models:</b>	ABE156X, ABG156S, CEC40M, CES24M, CES40M, CGC24M, CGC40M, CGS24M, CGS40M, EMT21P, EPE156T, EPEV15T, EPG156T, EPGV15T, FME201SX, GEMT21P, GEMT21T, GEMT40P, GEMT40T, GEVT21P, GEVT21T, GEVT40P, GEVT40T, GGMT21P, GGMT21T, GGMT40P, GG-MT40T, GGV21P, GGV21T, GGV240P, GGV240T, GSE201N, HME201P, HME201S, HME201T, HME201X, HME202P, HME202S, HME202T, HME202X, HMG201P, HMG201T, HMG201X, HMG202P, HMG202T, HMG202X, HVE201P, HVE201S, HVE201T, HVE201X...(Other models you can see in the webshop)		





hexagonal screws			
			
1			
<b>GEV No.</b>	550682	<b>Ref. No.</b>	58006410 LAR58006410
<b>description</b>	hexagonal screw thread M8 thread L 20mm SS WS 13 Qty 1 pcs DIN 933 / ISO 4017		
<b>For models:</b>	FMG201A, FMG201S, ME110L, ME110S, ME110T, ME120L, ME120S, ME120T, ME210L, ME210S, ME210T, ME220L, ME220S, ME220T, MG110L, MG110S, MG110T, MG120L, MG120S, MG120T, MG210L, MG210S, MG210T, MG220L, MG220S, MG220T, VE110L, VE110S, VE110T, VE120L, VE120S, VE210L, VE210S, VE210T, VG110L, VG110S, VG110T, VG210L, VG210S, VG210T		

			
1			
<b>GEV No.</b>	560594	<b>Ref. No.</b>	61020562 LA61020562 LAR61020562
<b>description</b>	hexagonal screw thread M6 thread L 20mm WS 10 total length 59mm		
<b>For models:</b>	ABE084S, ABE104S, ABE156X, ABG064M, ABG074M, ABG084X, ABG104X, ABG156S, ACE10M, ACG10M, AME10D, APG08M, APG10M, AREN064, AREN084, AREN154, ARES064, ARES084, ARES154, ARGN064, ARGN084, ARGN154, ARGS064, ARGS084, ARGS154, AVE10D, AVE10P, AVG10D, AVG20D, BPE084M, BPE084P, BPE104M, BPE104P, BPG084M, BPG084P, BPG104M, BPG104P, CE100M, CE110M, CE200M, CE210M, CEC40M, CES24M, CES40M, CG100M, CG110M, CG200M, CG210M, CGC24M, CGC40M...(Other models you can see in the webshop)		

cylinder head bolts			
DIN 912/ISO 4762			
			
1			
<b>GEV No.</b>	520455	<b>Ref. No.</b>	61030601 LA61030601 LAR61030601
<b>description</b>	screw thread M8 thread L 20mm WS 6 SS Qty 1 pcs DIN 912/ISO 4762		
<b>For models:</b>	ABE156X, ABG156S, EMT21P, EPE156T, EPEV15T, EPG156T, EPGV15T, GEMT21P, GEMT21T, GEMT40P, GEMT40T, GEVT21P, GEVT21T, GEVT40P, GEVT40T, GGMT21P, GGMT21T, GGMT40P, GGMT40T, GGV21P, GGV21T, GGV40P, GGV40T, GSE201N, HME201P, HME201S, HME201T, HME201X, HME202P, HME202S, HME202T, HME202X, HMG201P, HMG201T, HMG201X, HMG202P, HMG202T, HMG202X, HVE201P, HVE201S, HVE201T, HVE201X, HVE202P, HVE202T, HVE202X, HVG201P, HVG201T, HVG201X, HVG202P, HVG202T...(Other models you can see in the webshop)		

grub screws			
DIN 913/ISO 4026			
			
1			
<b>GEV No.</b>	560024	<b>Ref. No.</b>	61090052 LA61090052 LAR61090052
<b>description</b>	grub screw thread M6 L 16mm SS DIN 913/ISO 4026 intake internal hexagon WS 3 Qty 20 pcs		
<b>For models:</b>	ABE156X, ABG156S, CEC40M, CES24M, CES40M, CGC24M, CGC40M, CGS24M, CGS40M, EMT21P, EPE156T, EPEV15T, EPG156T, EPGV15T, FME201SX, GEMT21P, GEMT21S, GEMT21T, GEMT21X, GEMT40P, GEMT40S, GEMT40T, GEMT40X, GEVT21P, GEVT21S, GEVT21T, GEVT21X, GEVT40P, GEVT40S, GEVT40T, GEVT40X, GGMT21P, GGMT21S, GGMT21T, GGMT21X, GGMT40P, GGMT40S, GGMT40T, GGMT40X, GGV21P, GGV21S, GGV21T, GGV21X, GGV40P, GGV40S, GGV40T, GGV40X, GSE201N, HME201P, HME201S...(Other models you can see in the webshop)		

			
1			
<b>GEV No.</b>	560495	<b>Ref. No.</b>	61090592 LAR61090592
<b>description</b>	grub screw thread M8 L 16mm intake 4mm Qty 1 pcs		
<b>For models:</b>	FMG201A, FMG201S, ME120L, ME120S, ME120T, ME220L, ME220S, ME220T, MG120L, MG120S, MG120T, MG220L, MG220S, MG220T, VE120L, VE120S		

miscellaneous			
			
1			
<b>GEV No.</b>	690594	<b>Ref. No.</b>	58002560 LA58002560 LAR58002560
<b>description</b>	pressure screw for door hinge		
<b>For models:</b>	ABE156X, ABG156S, AREN154, ARES154, ARGN154, ARGS154, CEC40M, CES24M, CES40M, CGC24M, CGC40M, CGS24M, CGS40M, EMT21P, EPE156T, EPEV15T, EPG156T, EPGV15T, FME201SX, GEMT21P, GEMT21S, GEMT21T, GEMT21X, GEMT40P, GEMT40S, GEMT40T, GEMT40X, GEVT21P, GEVT21S, GEVT21T, GEVT21X, GEVT40P, GEVT40S, GEVT40T, GEVT40X, GGMT21P, GGMT21S, GGMT21T, GGMT21X, GGMT40P, GGMT40S, GGMT40T, GGMT40X, GGV21P, GGV21S, GGV21T, GGV21X, GGV40P, GGV40S, GGV40T, GGV40X...(Other models you can see in the webshop)		

			
1			
<b>GEV No.</b>	694991	<b>Ref. No.</b>	58006400 LA58006400 LAR58006400
<b>description</b>	screw thread M6 L 16mm for air baffle combi-steamer		
<b>For models:</b>	ABE044M, ABE054M, ABE084S, ABE104S, ACE04M, ACE05M, ACE10M, ACG10M, AME07D, AME07P, AME10D, APE06, APE07, APG08M, APG10M, AVE07D, AVE07P, AVE10D, AVE10P, AVG05P, AVG10D, AVG20D, BPE044M, BPE044P, BPE054M, BPE054P, BPE064M, BPE064P, BPE074M, BPE074P, BPE084M, BPE084P, BPE104M, BPE104P, BPG044M, BPG044P, BPG054M, BPG054P, BPG064M, BPG064P, BPG074M, BPG074P, BPG084M, BPG084P, BPG104M, BPG104P, CBEN061, CBES061, CE041M, CE051M...(Other models you can see in the webshop)		

## nuts

## hexagonal nuts

DIN 934 / ISO 4032/8673

			
1			
<b>GEV No.</b>	560129	<b>Ref. No.</b>	LA61310322
<b>description</b>	hexagonal nut thread M5 H 4mm WS 8 SS DIN/ISO DIN 934 / ISO 4032/8673 Qty 1 pcs		

ISO 4033 / UNI5587

			
1			
<b>GEV No.</b>	550866	<b>Ref. No.</b>	58004020 LA58004020 LAR58004020
<b>description</b>	nut thread M10x1.5 H 10mm SS WS 17 Qty 1 pcs DIN/ISO DIN 934 / ISO 4032/8673 left-hand thread		
<b>For models:</b>	AME07D, AME07P, APE06, APE07, AVE07D, AVE07P, BPE064M, BPE064P, BPE074M, BPE074P, BPG064M, BPG064P, BPG074M, BPG074P, CE071M, CE106M, CG071M, CG105M, CG106M, CVE105H, CVE105M, CVG105H, CVG105M, EC106M, EM006H, EM006M+SC, EM106H, EM106M, EM106M+SC, EM106P, EMT06D, EV006M, EV006P, EV106H, EV106M, EV106M+SC, EV106P, EVT06D, EVT06P, FE051M, FE051X, FE105M, FE105X, FG051M, FG051X, FG105M, FG105X, FME61A, FME61S, GC106M...(Other models you can see in the webshop)		

## hexagonal nuts metric (without norm)

			
1			
<b>GEV No.</b>	550681	<b>Ref. No.</b>	58004050 LA58004050 LAR58004050
<b>description</b>	nut thread M12x1.25 H 5mm WS 17 brass Qty 1 pcs		
<b>For models:</b>	ABE044M, ABE054M, ABE084S, ABE104S, ABE156X, ABG064M, ABG074M, ABG084X, ABG104X, ABG156S, ACE10M, ACG10M, AME07D, AME07P, AME10D, APE06, APE07, APG08M, APG10M, AREN064, AREN084, AREN154, ARES064, ARES084, ARES154, ARGN064, ARGN084, ARGN154, ARGS064, ARGS084, ARGS154, AVE07D, AVE07P, AVE10D, AVE10P, AVG10D, AVG20D, BPE064M, BPE064P, BPE074M, BPE074P, BPE084M, BPE084P, BPE104M, BPE104P, BPG064M, BPG064P, BPG074M, BPG074P, BPG084M...(Other models you can see in the webshop)		

			
1			
<b>GEV No.</b>	691289	<b>Ref. No.</b>	58004830 LAR58004830
<b>description</b>	nut thread M18x1 H 5mm WS 22 brass Qty 1 pcs for door handle		
<b>For models:</b>	ACE04M, ACE05M, ACE10M, ACG10M, AME07D, AME07P, AME10D, APE06, APE07, APG08M, APG10M, AVE07D, AVE07P, AVE10D, AVE10P, AVG05P, AVG10D, AVG20D, BPE044M, BPE044P, BPE054M, BPE054P, BPE064M, BPE064P, BPE074M, BPE074P, BPE084M, BPE084P, BPE104M, BPE104P, BPG044M, BPG044P, BPG054M, BPG054P, BPG064M, BPG064P, BPG074M, BPG074P, BPG084M, BPG084P, BPG104M, BPG104P, CE041M, CE051M, CE071M, CE100M, CE106M, CE110M, CE200M, CE210M...(Other models you can see in the webshop)		

## washers

## spring washers

			
1			
<b>GEV No.</b>	697933	<b>Ref. No.</b>	61420021 LAR61420021
<b>description</b>	spring washer ID ø 13mm ED ø 24mm Qty 1 pcs		
<b>For models:</b>	ABE156X, ABG156S, CEC40M, CES24M, CES40M, CGC24M, CGC40M, CGS24M, CGS40M, EMT21P, EPE156T, EPEV15T, EPG156T, EPGV15T, FME201SX, FMG201A, FMG201S, GEMT21P, GEMT21T, GEMT40P, GEMT40T, GEVT21P, GEVT21T, GEVT40P, GEVT40T, GGMT21P, GGMT21T, GGMT40P, GGMT40T, GGVT21P, GGVT21T, GGVT40P, GGVT40T, GSE201N, HME201P, HME201S, HME201T, HME201X, HME202P, HME202S, HME202T, HME202X, HMG201P, HMG201T, HMG201X, HMG202P, HMG202T, HMG202X, HVE201P, HVE201S...(Other models you can see in the webshop)		

			
1			
<b>GEV No.</b>	696397	<b>Ref. No.</b>	61620091 LAR61620091
<b>description</b>	spring washer ID ø 6.3mm ED ø 14mm Qty 1 pcs		
<b>For models:</b>	ABE156X, ABG156S, AREN154, ARES154, ARGN154, ARGS154, CEC40M, CES24M, CES40M, CGC24M, CGC40M, CGS24M, CGS40M, EMT21P, EPE156T, EPEV15T, EPG156T, EPGV15T, FME201SX, GEMT21P, GEMT21S, GEMT21T, GEMT21X, GEMT40P, GEMT40S, GEMT40T, GEMT40X, GEVT21P, GEVT21S, GEVT21T, GEVT21X, GEVT40P, GEVT40S, GEVT40T, GEVT40X, GGMT21P, GGMT21S, GGMT21T, GGMT21X, GGMT40P, GGMT40S, GGMT40T, GGMT40X, GGVT21P, GGVT21S, GGVT21T, GGVT21X, GGVT40P, GGVT40S, GGVT40T...(Other models you can see in the webshop)		

## washers

DIN 125A

			
1			
<b>GEV No.</b>	560312	<b>Ref. No.</b>	50000590
<b>description</b>	plain washer ID ø 10.5mm ED ø 20mm thickness 2mm SS Qty 1 pcs DIN 125A for thread M10		



miscellaneous			
 <p>1</p>			
<b>GEV No.</b>	691296	<b>Ref. No.</b>	61400052 LA61400052 LAR61400052
<b>description</b>	plain washer ID ø 10.5mm ED ø 21mm thickness 2mm SS Qty 1 pcs for fan wheel		
<b>For models:</b>	ABG064M, ABG074M, AME07D, AME07P, APE06, APE07, AVE07D, AVE07P, BPE064M, BPE064P, BPE074M, BPE074P, BPG064M, BPG064P, BPG074M, BPG074P, CE071M, CE106M, CG071M, CG105M, CG106M, CVE105H, CVE105M, CVG105H, CVG105M, EC106M, EM006H, EM006M+SC, EM106H, EM106M, EM106M+SC, EM106P, EMT06D, EV006M, EV006P, EV106H, EV106M, EV106M+SC, EV106P, EVT06D, EVT06P, FE051M, FE051X, FE105M, FE105X, FG051M, FG051X, FG105M, FG105X, FME61A...(Other models you can see in the webshop)		

 <p>1</p>			
<b>GEV No.</b>	691292	<b>Ref. No.</b>	10401710 LAR10401710
<b>description</b>	plain washer ID ø 12mm ED ø 17.5mm thickness 1mm SS Qty 1 pcs		
<b>For models:</b>	ACE10M, ACG10M, AME07D, AME07P, AME10D, APE06, APE07, APG08M, APG10M, AVE07D, AVE07P, AVE10D, AVE10P, AVG10D, AVG20D, BPE064M, BPE064P, BPE074M, BPE074P, BPE084M, BPE084P, BPE104M, BPE104P, BPG064M, BPG064P, BPG074M, BPG074P, BPG084M, BPG084P, BPG104M, BPG104P, CE071M, CE100M, CE106M, CE110M, CE200M, CE210M, CG071M, CG100M, CG106M, CG110M, CG200M, CG210M, EMT06D, EMT10D, EMT20P, EPE056T, EPE086T, EPEV05T, EPEV08T...(Other models you can see in the webshop)		

 <p>1</p>			
<b>GEV No.</b>	690593	<b>Ref. No.</b>	58002570 LA58002570 LAR58002570
<b>description</b>	plain washer ID ø 15mm ED ø 30mm thickness 3mm Qty 1 pcs for door hinge		
<b>For models:</b>	ABE156X, ABG156S, AREN154, ARES154, ARGN154, ARGS154, CEC40M, CES24M, CES40M, CGC24M, CGC40M, CGS24M, CGS40M, EMT21P, EPE156T, EPEV15T, EPG156T, EPGV15T, FME201SX, GEMT21P, GEMT21S, GEMT21T, GEMT21X, GEMT40P, GEMT40S, GEMT40T, GEMT40X, GEVT21P, GEVT21S, GEVT21T, GEVT21X, GEVT40P, GEVT40S, GEVT40T, GEVT40X, GGMT21P, GGMT21S, GGMT21T, GGMT21X, GGMT40P, GGMT40S, GGMT40T, GGMT40X, GGV21P, GGV21S, GGV21T, GGV21X, GGV240P, GGV240S, GGV240T...(Other models you can see in the webshop)		

 <p>1</p>			
<b>GEV No.</b>	551434	<b>Ref. No.</b>	58004010 LA58004010 LAR58004010
<b>description</b>	plain washer ø 30mm thickness 3mm hole ø 12.5mm for fan wheel combi-steamer		
<b>For models:</b>	ABE084S, ABE104S, ABE156X, ABG084X, ABG104X, ABG156S, ACE10M, ACG10M, AME10D, APG08M, APG10M, AREN064, AREN084, AREN154, ARES064, ARES084, ARES154, ARGN064, ARGN084, ARGN154, ARGS064, ARGS084, ARGS154, AVE10D, AVE10P, AVG10D, AVG20D, BPE084M, BPE084P, BPE104M, BPE104P, BPG084M, BPG084P, BPG104M, BPG104P, CE100M, CE110M, CE200M, CE210M, CEC40M, CES24M, CES40M, CG100M, CG110M, CG200M, CG210M, CGC24M, CGC40M, CGS24M, CGS40M...(Other models you can see in the webshop)		

fasteners

clamps

hose clamps

DIN 3017 - W2

 <p>1</p>			
<b>GEV No.</b>	520112	<b>Ref. No.</b>	61630011 LAR61630011
<b>description</b>	hose clamp ø 12-20mm width 9mm Qty 10 pcs DIN 3017		
<b>For models:</b>	ABE084S, ABE104S, ABE156X, ABG084X, ABG104X, ABG156S, AME07D, AME07P, AME10D, AREN084, AVE07D, AVE07P, AVE10D, AVE10P, AVG05P, AVG10D, AVG20D, CE106M, CE110M, CE210M, CEC40M, CES24M, CES40M, CEV061S, CEV061X, CG105M, CG106M, CG110M, CG210M, CGC24M, CGC40M, CGS24M, CGS40M, CKES10, CME061X, CVE004H, CVE004M, CVE024S, CVE061S, CVE104H, CVE104M, CVE105H, CVE105M, CVG105H, CVG105M, ECO20M, EC106M, EC110M, EC210M, EM006H...(Other models you can see in the webshop)		

 <p>1</p>			
<b>GEV No.</b>	520454	<b>Ref. No.</b>	61630041
<b>description</b>	hose clamp ø 70-90mm width 9mm Qty 5 pcs DIN 3017		

consumables

sealants and adhesives

high temperature silicone



<b>GEV No.</b>	890037	<b>Ref. No.</b>	85010015 LAR85010015
<b>description</b>	high temperature silicone MOMENTIVE RTV106 -60 up to +260°C red tube 83ml		
<b>description</b>	<p>Momentive RTV106 - tube 83ml - red</p> <p>Used for sealing heating elements, gasketing, electrical insulation, and other critical bonding and sealing applications where parts must perform at high temperatures. Can be applied to vertical or overhead surfaces.</p> <p>Capability to cure at room temperature and ambient humidity, low temperature flexibility, excellent weatherability and ozone and chemical resistance, excellent electrical insulation properties.</p> <p>Temperature range -60°C to +260°C</p> <p>NSF approved</p>		

cleaning agents

combisteamer detergents/descalers

*Notice: Articles labelled 'DANGEROUS GOODS' are delivered by road through a forwarder for reasons of safety and are charged separately!*



<b>GEV No.</b>	802065	<b>Ref. No.</b>	85150080 CF010 CR0349981 LA85150080 LAR85150080
<b>description</b>	descaler CALFREE Qty 1 pcs 10l		
<b>description</b>			

<b>GEV No.</b>	802112	<b>Ref. No.</b>	85150140 LA85150140 LAR85150140 SCA01
<b>description</b>	descaler for combi-steamer LAINOX SOLID CAL 6 cans of 850g		
<b>description</b>	<p>LAINOX SOLID CAL - descaler - 6 cans of 1kg (powder)</p> <p>Is a LAINOX product that hinders limescale formation in steam generators. SOLID CAL offers a number of advantages:</p> <ul style="list-style-type: none"> <li>- Faults caused by limescale deposits are avoided</li> <li>- A sufficient amount of clean steam is always available</li> <li>- Maximum energy efficiency and hence reduced consumption</li> <li>- High performance even after a long running time</li> </ul> <p>- Longer steam generator life SOLID CLEAN with a new formula has a maximum disinfecting action, can be transported without a permit (not a liquid), takes us little space (solid) and rehydrates during use.</p>		

<b>GEV No.</b>	802039 <sup>1</sup>	<b>Ref. No.</b>	331520 85150020 CR0331520 LA85150020 LAR85150020
<b>description</b>	detergent for combi-steamer LAINOX Combi Clean 10 litres		
<b>description</b>	<p>LAINOX Combi Clean - detergent - canister 10l</p> <p>Triple-action alkaline detergent, specially designed for cleaning the cooking chambers of Lainox combi steamers. With its special 3-in-1 formula with detergent, rinse aid and descaler the detergent removes food residue and gives the cooking chamber a streak-free shine. The detergent helps ensure a long seal life. Can corrode metals.</p>		

<sup>1</sup>DANGEROUS GOODS

<b>GEV No.</b>	802105	<b>Ref. No.</b>	85150130 CR0331521 LA85150130 LAR85150130 SCL01
<b>description</b>	detergent for combi-steamer LAINOX SOLID CLEAN 6 cans of 930g		
<b>description</b>	<p>LAINOX SOLID CLEAN - detergent - 6 cans of 1kg</p> <p>SOLID CLEAN with a new formula has a maximum disinfecting action, can be transported without a permit (not a liquid), takes us little space (solid) and rehydrates during use.</p>		





fuses

fine fuses



1

<b>GEV No.</b>	358662	<b>Ref. No.</b>	65200080
<b>description</b>	fine fuse size ø5x20mm 0.125A fast-acting rated 250V Qty 10 pcs		
<b>For models:</b>	FME61A, FME61S, ME004L, ME004S, ME104L, ME104S, ME105L, ME105S, ME106L, ME106S, ME106T, ME110L, ME110S, ME110T, ME120L, ME120S, ME120T, ME210L, ME210S, ME210T, ME220L, ME220S, ME220T, MG105L, MG105S, MG106L, MG106S, MG106T, MG110L, MG110S, MG110T, MG120L, MG120S, MG120T, MG210L, MG210S, MG210T, MG220L, MG220S, MG220T, VE004S, VE104S, VE105S, VE106L, VE106S, VE106T, VE110L, VE110S, VE110T, VE210L... (Other models you can see in the webshop)		



1

<b>GEV No.</b>	358532	<b>Ref. No.</b>	65200200 LAR65200200 LAR65200200
<b>description</b>	fine fuse size ø5x20mm 2A fast-acting rated 250V Qty 10 pcs		
<b>For models:</b>	ABE044M, ABE054M, ABE084S, ABE104S, ABE156X, ABG156S, ACE04M, ACE05M, ACE10M, ACG10M, AME07D, AME07P, AME10D, APE06, APE07, APG08M, APG10M, AVE07D, AVE07P, AVE10D, AVE10P, AVG05P, AVG10D, AVG20D, BPE044M, BPE044P, BPE054M, BPE054P, BPE064M, BPE064P, BPE074M, BPE074P, BPE084M, BPE084P, BPE104M, BPE104P, BPG044M, BPG044P, BPG054M, BPG054P, BPG064M, BPG064P, BPG074M, BPG074P, BPG084M, BPG084P, BPG104M, BPG104P, CE041M, CE051M...(Other models you can see in the webshop)		



1

<b>GEV No.</b>	358678	<b>Ref. No.</b>	65200370 LAR65200370
<b>description</b>	fine fuse size ø5x20mm 8A fast-acting rated 250V Qty 10 pcs		



1

<b>GEV No.</b>	358593	<b>Ref. No.</b>	65200086 LAR65200086 R65200088
<b>description</b>	fine fuse size ø5x20mm 0.125A slow-acting rated 250V Qty 10 pcs		
<b>For models:</b>	ABE044M, ABE054M, ABE084S, ABE104S, AVG05P, BPE044M, BPE044P, BPE054M, BPE054P, BPE064M, BPE064P, BPE074M, BPE074P, BPE084M, BPE084P, BPE104M, BPE104P, BPG044M, BPG044P, BPG054M, BPG054P, BPG064M, BPG064P, BPG074M, BPG074P, BPG084M, BPG084P, BPG104M, BPG104P, CVE004H, CVE104H, CVE105H, CVG105H, EM006H, EM006M+SC, EM010M+SC, EM106H, EM106M+SC, EM106P, EM110M+SC, EM110P, EM210M+SC, EM210P, EMT20P, EMT21P, EPE056T, EPE086T, EPE156T, EPEV05T, EPEV08T... (Other models you can see in the webshop)		



1

<b>GEV No.</b>	358592	<b>Ref. No.</b>	65200140 65200300 LAR65200300 LAR65200140 LAR65200300
<b>description</b>	fine fuse size ø5x20mm 0.1A slow-acting rated 250V Qty 10 pcs		
<b>For models:</b>	GMT20D, ME004L, ME004S, ME104L, ME104S, ME105L, ME105S, ME106L, ME106S, ME110L, ME110S, ME120L, ME120S, ME210L, ME210S, ME220L, ME220S, MG061M, MG101D, MG101M, MG102D, MG102M, MG105L, MG105S, MG106L, MG106S, MG110L, MG110S, MG120L, MG120S, MG201D, MG201M, MG210L, MG210S, MG220L, MG220S, MGMT20D, VG101D, VG101M, VG102D, VG102M, VG201D, VG201M		



1

<b>GEV No.</b>	358595	<b>Ref. No.</b>	65200145 65200320 LAR65200320 LAR65200145 LAR65200320
<b>description</b>	fine fuse size ø5x20mm 0.2A slow-acting rated 250V Qty 10 pcs		
<b>For models:</b>	ACE10M, AVE10D, AVG10D, AVG20D, BPE064P, BPE074P, BPG064P, BPG074P, CE100M, CE106M, CE200M, CG106M, EC106M, EM006H, EM006M+SC, EM010H, EM106H, EM106M, EM106M+SC, EM106P, EM110H, EM110P, EM210H, EM210P, EMT10D, EPE056T, EPEV05T, EPG056T, EPGV05T, EV006M, EV006P, EV010H, EV010P, EV106H, EV106M, EV106M+SC, EV106P, EV110H, EV110P, EV210H, EV210P, EVT20D, FE051X, FE1102P, FG051X, FG105X, FME101AX, FME201SX, FME61S, GC106M...(Other models you can see in the webshop)		



1

<b>GEV No.</b>	358703	<b>Ref. No.</b>	65200350 LAR65200350 LAR65200350
<b>description</b>	fine fuse size ø5x20mm 0.4A slow-acting rated 250V Qty 10 pcs		
<b>For models:</b>	ABE084S, ABE104S, ABE156X, ABG156S, BPE084P, BPE104P, BPG084P, BPG104P, CE110M, CE210M, CEC40M, CES24M, CES40M, CG110M, CG210M, CGC24M, CGC40M, CGS24M, CGS40M, ECO20M, EC110M, EC210M, EM010H, EM010M+SC, EM020M, EM110H, EM110M, EM110M+SC, EM110P, EM210H, EM210M, EM210M+SC, EM210P, EPE086T, EPE156T, EPEV08T, EPEV15T, EPG086T, EPG156T, EPGV08T, EPGV15T, EV010H, EV010M, EV010P, EV020M, EV110H, EV110M, EV110M+SC, EV110P, EV210H...(Other models you can see in the webshop)		



1

<b>GEV No.</b>	358600	<b>Ref. No.</b>	65200160
<b>description</b>	fine fuse size ø5x20mm 1A slow-acting rated 250V Qty 10 pcs		



			
1			
<b>GEV No.</b>	358603	<b>Ref. No.</b>	50304780
<b>description</b>	fine fuse size ø5x20mm 2A slow-acting rated 250V Qty 10 pcs		

			
1			
<b>GEV No.</b>	358609	<b>Ref. No.</b>	65200240 R65200240
<b>description</b>	fine fuse size ø5x20mm 5A slow-acting rated 250V Qty 10 pcs		
<b>For models:</b>	GEMT06T, GEVT06T, GGMT06T, GGVT06T, HME061T, HME061X, HMG061T, HMG061X, HVE061T, HVE061X, HVG061T, HVG061X, MG106M, MG106P, MG106X, MG110M, MG110P, MG110X, MG120M, MG120P, MG120X, MG210M, MG210P, MG210X, MG220M, MG220P, MG220X, MG227M, MG227P, MG227X		

fine fuse holders

			
1			
<b>GEV No.</b>	358512	<b>Ref. No.</b>	50302160 50305160 65210020 LA65210020 LAR50302160 LAR65210020
<b>description</b>	fuse holder		
<b>For models:</b>	ABE044M, ABE054M, ABE084S, ABE104S, ABG064M, ABG074M, ABG084X, ABG104X, ABG156S, ACE04M, ACE05M, ACE10M, ACG10M, AME07D, AME07P, AME10D, APE06, APE07, APG08M, APG10M, AREN084, AVE07D, AVE07P, AVE10D, AVE10P, AVG05P, AVG10D, AVG20D, BPE044M, BPE044P, BPE054M, BPE054P, BPE064M, BPE064P, BPE074M, BPE074P, BPE084M, BPE084P, BPE104M, BPE104P, BPG044M, BPG044P, BPG054M, BPG054P, BPG064M, BPG064P, BPG074M, BPG074P, BPG084M, BPG084P...(Other models you can see in the webshop)		

<b>A</b>			
alarm devices	24		
appliance hose reels	142		
axial fans	54		
<b>B</b>			
ball valves	149		
ball valves electric	53, 149		
bar burners	87		
beverage technology	149		
booster pumps II	68		
<b>C</b>			
cables	73		
cam switches	17		
castors and bumper angles	119		
clamps	150, 153		
cleaning agents	154		
combisteamer detergents/descalers	154		
condensators & interference suppression filters	69		
consumables	154		
contactors	25		
container filters	142		
control equipment	18		
control thermostats	8		
cylinder head bolts	151		
<b>D</b>			
door catches	112		
door seals	124		
door seals with fixing hook	136		
dosing pumps	142		
double nipples	145		
drain pumps	68		
<b>E</b>			
edgemount latches	111		
electric accessories	73		
electric timers	24		
electrodes	53		
electronic controllers	35		
electronic magnets	74		
energy regulators	8		
espagnolette locks	112		
<b>F</b>			
fans	54		
fasteners	153		
fastening material	150		
ferrite rings	70		
filters	70		
fine fuses	155		
		fittings	145
		float switches	16
		forced air burners	89
		formed hoses	144
		fuses	71, 155
<b>G</b>			
		gas burners	87
		gas control valves	74
		gas nozzles	89
		gaskets for heated units	120
		gaskets for tray rack trolleys	137
		GEV	2
		grates	120
		grub screws	151
<b>H</b>			
		halogen lamp	20
		hand tools	150
		handle latches	111
		heating elements	2
		heating elements for convection	3
		hexagonal nuts	152
		hexagonal screws	151
		high temperature silicone	154
		hose clamps	150, 153
		hose connectors	145
		hose reels	142
		hoses	143
		hot air fans	66
		hot air motors	55
<b>I</b>			
		ignition boxes	77
		ignition cables	84
		ignition units	85
		immersion heating elements	2
		indicator lights	19
		indicator lights (complete)	19
		industrial hoses	143
<b>L</b>			
		lamps	19
		light bulbs	20
<b>M</b>			
		magnetic switches	18
		measuring equipment	150
		microswitches	15
		motors	68
<b>N</b>			
		Niplaflex hoses	143

non-return valves	149	timers	22
nuts	152	tools	150
<b>O</b>		touch sensitive light switches	18
operating capacitors	69	transformers	33
O-rings	138	<b>U</b>	
oven lamps	20	universal probes	35
<b>P</b>		<b>V</b>	
PE hoses	143	valves	149
pilot burners	79	valves and tank inlets	149
pre-rinse hoses	143	vibration pumps	69
pressure switches	53, 91	<b>W</b>	
probes	35	washers	152
programme timers	22	window seals	120
PU hoses	143		
pullers	150		
pumps	68		
push/momentary push switches	14		
push-in fittings	146		
PVC hoses	143		
<b>R</b>			
radial fans	67		
raised countersunk head screws	150		
relays	31		
ribbon cables	73		
rocker/momentary rocker switches	13		
rotary switches	17		
<b>S</b>			
safety thermostats	11		
screw pipe fittings	145		
screws	150		
sealants and adhesives	154		
sealing washers	138		
shaft gaskets	139		
shelves and shelf rails	120		
silicone	154		
silicone hoses	144		
snap locks	112		
solenoid valves	49		
spray guns	141		
spring washers	152		
stainless steel flexi hoses	143		
switches and momentary switches	13		
<b>T</b>			
temperature probes	35		
terminals	73		
thermocouples	86		
thermostats	8		
time relays	32		