



Spare Parts for Ovens & Combi Ovens



Spare parts suitable for

OLIS

2018

Find the complete and up-to-date range of products in our GEV Webshop



heating elements



immersion heating elements

with round flange ø57.5mm



GEV No.	415849	Ref. No.	R65020420 R65020421
description	heating element 15000W 230V heating circuits 3 mounting ø 57.5mm L 530mm W 45mm H 30mm round flange connection M4 immersion heater tube ø 8.5mm connection length 15mm thermostat sleeves ø 7mm number of thermostat sleeves 1 length thermostat sleeves 272mm thermostat sleeve eccentric, clinging		
For models:	CKEP20B, CKEP21B, CKEP40B, CKET20B, CKET21B, CKET40B		
spare parts for	415849		
	GEV No.	550002	Ref. No. 16045
	tension strap H 10mm L 21mm W 10mm hole ø 6.5mm for heating element		





GEV No.	415848	Ref. No.	R65020350
description	heating element 7500W 230V heating circuits 3 mounting ø 57.5mm L 365mm W 36mm H 50mm round flange connection M4 immersion heater tube ø 8.5mm thermostat sleeves ø 7.5mm number of thermostat sleeves 1 length thermostat sleeves 270mm thermostat sleeve eccentric, clinging		
For models:	CKEP06B, CKEP10B, CKET06B, CKET10B		
spare parts for	415848		
	GEV No.	510409	Ref. No. 13015 LA70045010 LAR70045010 R70045010
	O-ring EPDM thickness 5.34mm ID ø 56.52mm Qty 1 pcs		
accessories for	415848		
	GEV No.	550002	Ref. No. 16045
	tension strap H 10mm L 21mm W 10mm hole ø 6.5mm for heating element		



GEV No.	418112	Ref. No.	6A037484 BN6A037484
description	heating element 15000W 220V heating circuits 6 L 310mm W 230mm H 130mm thermostat sleeves ø 6/4mm length thermostat sleeves 137/125mm number of thermostat sleeves 2 thermostat sleeve clinging / not clinging connection male faston 6.3mm immersion heater		
For models:	CVP10E, CVP10E-1320700, CVP10E-2, CVP10E2-1320740, CVP10E2S-1320790, CVP10E-S, CVP10ES-1320750, CVP10E-S2, CVP10G, CVP10G-1310700, CVP10G-1310750, CVP10G-2, CVP10G2-1310740, CVP10GP-1310700, CVP10G-S, CVP10G-S2, CVP10GS2-1310790, CVP20E, CVP20E-1320800, CVP20E-2, CVP20E2-1320840, CVP20E-S, CVP20ES-1320850, CVP20E-S2, CVP20ES2-1320890, CVP20G, CVP20G-1310800, CVP20G-1310850, CVP20G-2, CVP20G-S, CVP20GS-1310840, CVP20G-S2, CVP20GS2-1310890, CVP21E, CVP21E-1322700, CVP21E-2, CVP21E-S, CVP21ES-1322750, CVP21E-S2, CVP21ES2-1322790, CVP21G, CVP21G-1312700, CVP21G-2, CVP21G2-1312740, CVP21G-S, CVP21GS-1312750, CVP21G-S2, CVP21GS2-1312790, ECVM10ES2, ECVM10ES2-1324290...(Other models you can see in the webshop)		
accessories for	418112		
	GEV No.	550692	Ref. No. 6A037485 A037485 BN6A037485
	gasket silicone thickness 7mm ID ø 193.7mm Qty 1 pcs for heating element suitable for BARON equiv. no. A037485		







			
1			
GEV No.	418111	Ref. No.	6A037483 BN6A037483
description	heating element 7500W 220V heating circuits 6 L 310mm W 145mm H 130mm thermostat sleeves ø 6x4mm length thermostat sleeves 137/125mm number of thermostat sleeves 2 thermostat sleeves clinging / not clinging connection male faston 6.3mm immersion heater special fixing		
For models:	CVP6E, CVP6E-1320600, CVP6E-2, CVP6E2-1320640, CVP6E-S, CVP6ES-1320650, CVP6E-S2, CVP6ES2-1320690, CVP6G, CVP6G-1310600, CVP6G-2, CVP6G2-1310640, CVP6G-S, CVP6GS-1310650, CVP6G-S2, CVP6GS2-1310690, ECV6ES2, ECV6ES2-1324190, ECV6ES2-1326100, ECV6ES2-1326100H, ECV6GS2, ECV6GS2-1314190, ECV6GS2-1316100, ECV6ES2, ECV6ES2-1324590, ECV6ES2-1326180, ECV6GS2, ECV6GS2-1314590, ECV6GS2-1316180, FCV6E, FCV6E-2, FCV6E-2-418035420640, FCV6E-2S, FCV6E-2S-418035420690, FCV6E-418035420600, FCV6E-S, FCV6E-S-418035420650, FCV6G-2-418035410640, FCV6G-2S-418035410690, FCV6G-418035410600, FCV6G-S-418035410650, NECVM6ES2, NECVM6ES2-1327190, NECVM6ES2-1328100, NECVM6GS2, NECVM6GS2-1317190, NECVM6GS2-1318100, NECVP6ES2, NECVP6ES2-1327590, NECVP6ES2-1328180...(Other models you can see in the webshop)		
accessories for	418111		
			
GEV No.	550692	Ref. No.	6A037485 A037485 BN6A037485
description	gasket silicone thickness 7mm ID ø 193.7mm Qty 1 pcs for heating element suitable for BARON equiv. no. A037485		

			
1			
GEV No.	415828	Ref. No.	LAR65011310
description	heating element 15000W 230V heating circuits 3 ID ø 388mm ED ø 408mm L 428mm H 132mm L1 20mm W1 105mm H1 114mm H2 18mm flange length 140mm flange width 25mm hole distance 126mm connection M4 connection length 65mm tube ø 8.5mm convection heating element hole ø 6.3mm rectangular flange		
For models:	CCE101M, CKEP10, CKEP10B, CKEP20, CKEP20B, CKEP21, CKEP21B, CKEP40, CKEP40B, CKET10, CKET10B, CKET20, CKET20B, CKET21, CKET21B, CKET40, CKET40B		

			
1			
GEV No.	418197	Ref. No.	LAR65011250
description	heating element 15000W 230V heating circuits 3 ID ø 512mm ED ø 530mm L 545mm H 130mm L1 15mm W1 105mm H1 25mm H2 105mm flange length 142mm flange width 25mm hole distance 126mm connection M4 connection length 68mm tube ø 8.5mm convection heating element hole ø 6mm rectangular flange		
For models:	CKEP20, CKEP20B, CKEP40, CKEP40B, CKET20, CKET20B, CKET40, CKET40B		



heating elements for convection

			
1			
GEV No.	418110	Ref. No.	6A037470 BN6A037470
description	heating element 10500W 230V heating circuits 3 ID ø 370mm ED ø 384mm L 405mm H 141mm L1 20mm W1 105mm H1 41mm H2 100mm flange length 142mm flange width 25mm hole distance 63mm connection M5 tube ø 6.5mm convection heating element hole ø 6mm rectangular flange		
For models:	CV20E, CV20E-1320200, CV20E-2, CV20E2-1320240, CV20EB-1321200, CV20E-S, CV20ES-1320250, CV20E-S2, CV20ES2-1320290, CVM20E, CVM20E-1320500, CVM20E-2, CVM20E2-1320540, CVM20E-S, CVM20ES-1320550, CVM20E-S2, CVM20ES2-1320590, CVP20E, CVP20E-1320800, CVP20E-2, CVP20E2-1320840, CVP20EB-1321200, CVP20E-S, CVP20ES-1320850, CVP20E-S2, CVP20ES2-1320890, ECV20ES2, ECV20ES2-1324390, ECV20ES2-1326140, ECV20ES2, ECV20ES2-1324790, ECV20ES2-1326220, FC20E, FC20E-2, FC20E-2-418035420240, FC20E-2S, FC20E-2S-418035420290, FC20E-418035420200, FC20E-S, FC20E-S-418035420250, FC-M20E, FCM20E-2, FCM20E-2-418035420540, FCM20E-2S, FCM20E-2S-418035420590, FCM20E-418035420500, FCM20E-S, FCM20E-S-418035420550, FCV20E, FCV20E-2...(Other models you can see in the webshop)		

			
1			
GEV No.	415966	Ref. No.	1037300200
description	heating element 2500W 230V heating circuits 1 ID ø 176mm ED ø 188mm L 210mm H 28mm L1 22mm W1 30mm H1 3mm H2 25mm flange length 70mm flange width 22mm hole distance 56mm connection male faston 6.3mm tube ø 6.3mm convection heating element hole ø 5mm rectangular flange		
For models:	FOE60M, OFOE60M, OFOE-60M-12601001		
spare parts for	415966		
			
GEV No.	510368	Ref. No.	—
description	gasket L 70mm W 23.5mm hole ø 5mm hole distance 56mm FIBER thickness 2mm for heating element		
accessories for	415966		
			
GEV No.	510368	Ref. No.	—
description	gasket L 70mm W 23.5mm hole ø 5mm hole distance 56mm FIBER thickness 2mm for heating element		

			
1			
GEV No.	415845	Ref. No.	R65010320
description	heating element 3150W 230V heating circuits 3 ID ø 201mm ED ø 215mm L 272mm H 35mm L1 57mm W1 60mm H1 8mm H2 27mm flange length 95mm flange width 22mm hole distance 77mm connection male faston 6.3mm connection length 20mm tube ø 6.5mm convection heating element hole ø 6mm rectangular flange		
For models:	CCE042M		

			
1			
GEV No.	418196	Ref. No.	R65011530
description	heating element 6000W 230V heating circuits 3 ID ø 215mm ED ø 228mm L 266mm H 78mm L1 38mm W1 102mm H1 10mm H2 68mm flange length 142mm flange width 25mm hole distance 57mm connection M4 connection length 66mm tube ø 6.3mm convection heating element hole ø 6mm rectangular flange		
For models:	CCE051M		

			
1			
GEV No.	415829	Ref. No.	R65011540
description	heating element 7500W 230V heating circuits 3 ID ø 248mm ED ø 260mm L 287mm H 88mm L1 20mm W1 105mm H1 23mm H2 65mm flange length 142mm flange width 25mm hole distance 64mm connection M4 connection length 78mm convection heating element hole ø 5mm rectangular flange		
For models:	CCE071M, CKEP06, CKEP06B, CKET06, CKET06B		
accessories for	415829		
	GEV No.	531270	Ref. No. —
	gasket L 141mm W 22mm D1 ø 10mm D2 ø 9mm 9 holes graphite thickness 1mm suitable for UNOX		

			
1			
GEV No.	418107	Ref. No.	6A037460 BN6A037460
description	heating element 7500W 230V heating circuits 3 ID ø 368mm ED ø 385mm L 405mm H 135mm L1 24mm W1 105mm H1 35mm H2 100mm flange length 142mm flange width 24mm hole distance 64mm connection M5 connection length 92mm tube ø 8.5mm convection heating element hole ø 5.5mm rectangular flange		
For models:	CMV6ES2-1320392, CV10E, CV10E-1320100, CV10E-1320110, CV10E-2, CV10E2-1320140, CV10EB-1321100, CV10E-S, CV10ES-1320150, CV10E-S2, CV10ES2-1320190, CV21E, CV21E-1322100, CV21E-2, CV21E2-1322140, CV21E-S, CV21ES-1322150, CV21E-S2, CV21ES2-1322190, CV6E, CV6E-1320000, CV6E-1320010, CV6E-1320050, CV6E-2, CV6E2-1320040, CV6EB-1321000, CV6E-S, CV6E-S2, CV6ES2-1320090, CVM10E, CVM10E-1320400, CVM10E-1320410, CVM10E-2, CVM10E2-1320440, CVM10E-S, CVM10ES-1320450, CVM10E-S2, CVM10ES2-1320490, CVM21E, CVM21E-1322400, CVM21E-2, CVM21E2-1322440, CVM21E-S, CVM21ES-1322450, CVM21E-S2, CVM21ES2-1322490, CVM6E, CVM6E-1320300, CVM6E-1320340, CVM6E-1320390...(Other models you can see in the webshop)		

			
1			
GEV No.	418108	Ref. No.	6A037480 BN6A037480
description	heating element 7500W 230V heating circuits 3 ID ø 475mm ED ø 495mm L 515mm H 143mm L1 15mm W1 105mm H1 43mm H2 100mm flange length 142mm flange width 25mm hole distance 64mm connection M4 tube ø 8.5mm convection heating element hole ø 6mm rectangular flange		
For models:	CV10E, CV10E-1320100, CV10E-1320110, CV10E-2, CV10E2-1320140, CV10EB-1321100, CV10E-S, CV10ES-1320150, CV10E-S2, CV10ES2-1320190, CV21E, CV21E-1322100, CV21E-2, CV21E2-1322140, CV21E-S, CV21ES-1322150, CV21E-S2, CV21ES2-1322190, CVM10E, CVM10E-1320400, CVM10E-1320410, CVM10E-2, CVM10E2-1320440, CVM10E-S, CVM10ES-1320450, CVM10E-S2, CVM10ES2-1320490, CVM21E, CVM21E-1322400, CVM21E-2, CVM21E2-1322440, CVM21E-S, CVM21ES-1322450, CVM21E-S2, CVM21ES2-1322490, CVP10E, CVP10E-1320700, CVP10E-1320710, CVP10E-2, CVP10E2-1320740, CVP10E2S-1320790, CVP10E-S, CVP10ES-1320750, CVP10ES-1320760, CVP10E-S2, CVP21E, CVP21E-1322700, CVP21E-2, CVP21E-S, CVP21ES-1322750...(Other models you can see in the webshop)		



			
GEV No.	419110	Ref. No.	R65011900
description	heating element 9000W 230V heating circuits 3 ID ϕ 250mm ED ϕ 266mm L 290mm H 93mm L1 24mm W1 105mm H1 11mm H2 82mm flange length 142mm flange width 25mm hole distance 63mm connection M4 tube ϕ 8.5mm hole ϕ 6.1mm		
For models:	CKEP06, CKEP06B, CKET06, CKET06B		

			
GEV No.	418109	Ref. No.	6A037475 BN6A037475
description	heating element 9000W 230V heating circuits 3 ID ϕ 470mm ED ϕ 485mm L 520mm H 155mm L1 18mm W1 104mm H1 50mm H2 105mm flange length 142mm flange width 25mm hole distance 63mm connection M5 tube ϕ 6.5mm convection heating element hole ϕ 6.3mm rectangular flange		
For models:	CV20E, CV20E-1320200, CV20E-2, CV20E2-1320240, CV20EB-1321200, CV20E-S, CV20ES-1320250, CV20E-S2, CV20ES2-1320290, CVM20E, CVM20E-1320500, CVM20E-2, CVM20E2-1320540, CVM20E-S, CVM20ES-1320550, CVM20E-S2, CVM20ES2-1320590, CVP20E, CVP20E-1320800, CVP20E-2, CVP20E2-1320840, CVP20EB-1321200, CVP20E-S, CVP20ES-1320850, CVP20E-S2, CVP20ES2-1320890, ECV20ES2, ECV20ES2-1324390, ECV20ES2-1326140, ECV20ES2, ECV20ES2-1324790, ECV20ES2-1326220, FC20E, FC20E-2, FC20E-2-418035420240, FC20E-2S, FC20E-2S-418035420290, FC20E-418035420200, FC20E-S, FC20E-S-418035420250, FCM20E, FCM20E-2, FCM20E-2-418035420540, FCM20E-2S, FCM20E-2S-418035420590, FCM20E-418035420500, FCM20E-S, FCM20E-S-418035420550, FCV20E, FCV20E-2...(Other models you can see in the webshop)		

accessories

sealing washers

fibre gaskets

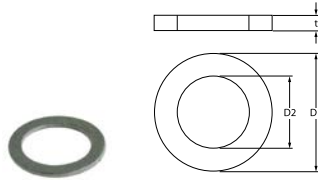
			
GEV No.	510404	Ref. No.	6A022280 BN6A022280
description	flat gasket fibre ED ϕ 44mm ID ϕ 34mm thickness 2mm Qty 1 pcs		
For models:	74-02NPEI, 74-02NPEI-12701755, 74-02NPGD, 74-02NPGD-12700750, 74-02NPGI, 74-02NPGI-12700755, 7NP-G50, 7NP-GI50, 7PN-EI50		

<p>O-rings</p> 			
GEV No.	505092	Ref. No.	BN0119472130
description	O-ring EPDM thickness 5.34mm ID ϕ 43.82mm Qty 1 pcs		

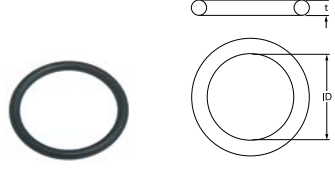
			
GEV No.	510408	Ref. No.	13005
description	O-ring EPDM thickness 5.34mm ID ϕ 47mm Qty 1 pcs		
For models:	OLDS40-1081010, OLDS40D-1081011, OLDS40LS-1081012, OLDS40LSD-1081013, OLDS45, OLDS50, OLDS50-1081088, OLDS50D-1081089, OLDS50E-1081090, OLDS50ED-1081091, OLDS50-Neutra, OLDS50P-1081018, OLDS50PD-1081019, OLElectron500, OLG600, OLGastro450, OLGastro500Plus, OLGastro500S, OLGastro750Plus, OLGastro750S, OLG545, OLG550, OLG550-1080705, OLG550D-1080706, OLG550E-1080730, OLG550ECO-1081014, OLG550ECOD-1081015, OLG550ED-1080731, OLG550-Neutra, OLG585, OLG585-1081016, OLG585D-1081017, OLG585-Neutra, OLLLinear, OLLP-ZERO, OLLPZERO-1081057		

miscellaneous

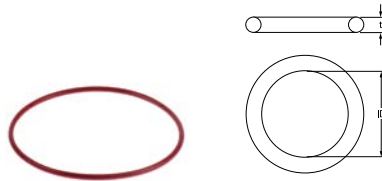
			
GEV No.	550692	Ref. No.	6A037485 BN6A037485
description	gasket silicone thickness 7mm ID ϕ 193.7mm Qty 1 pcs for heating element suitable for BARON equiv. no. A037485		
For models:	CVP10E, CVP10E-1320700, CVP10E-2, CVP10E2-1320740, CVP10E2S-1320790, CVP10E-S, CVP10ES-1320750, CVP10E-S2, CVP10G, CVP10G-1310700, CVP10G-1310750, CVP10G-2, CVP10G2-1310740, CVP10GP-1310700, CVP10G-S, CVP10G-S2, CVP10GS2-1310790, CVP20E, CVP20E-1320800, CVP20E-2, CVP20E2-1320840, CVP20E-S, CVP20ES-1320850, CVP20E-S2, CVP20ES2-1320890, CVP20G, CVP20G-1310800, CVP20G-1310850, CVP20G-2, CVP20G-S, CVP20GS-1310840, CVP20G-S2, CVP20GS2-1310890, CVP21E, CVP21E-1322700, CVP21E-2, CVP21E-S, CVP21ES-1322750, CVP21E-S2, CVP21ES2-1322790, CVP21G, CVP21G-1312700, CVP21G-2, CVP21G2-1312740, CVP21G-S, CVP21GS-1312750, CVP21G-S2, CVP21GS2-1312790, CVP6E, CVP6E-1320600...(Other models you can see in the webshop)		



energy regulators

EGO

1-circuit



GEV No.	380015	Ref. No.	0111641820 6A049320 BN0111641820
description	energy regulator 230V 13A single-circuit turn direction right shaft ø 6x4.6mm shaft L 23mm mounting thread M4 power release 6-100% no. 50.57021.010		
For models:	40SEW, 40SEW-1825190, 74-02CTE, 74-02CTE-12701170, 74-02CTEE, 74-02CTEE-12701180, 74-02NPEI, 74-02NPEI-12701755, 74-02TCTE, 74-02TCTE-12731170, 7PN-EI50, 7TP-E800, 7TPF-EE800, 7TPV-E800, 7TPVP-E800, 911PEB-1192805, 911RPEB-1392890, 915PEB-1192800, 96-04KBEC-12901105, 9BR-E100, 9BR-E105, 9BR-E100, 9BR-E105, CV10E, CV10E-1320100, CV10E-2, CV10E2-1320140, CV10EB-1321100, CV10E-S, CV10ES-1320150, CV10E-S2, CV10ES2-1320190, CV10G, CV10G-1310100, CV10G-2, CV10G2-1310140, CV10GB-1311100, CV10G-S, CV10GS-1310150, CV10G-S2, CV10GS2-1310190, CV20E, CV20E-1320200, CV20E-2, CV20E2-1320240, CV20EB-1321200, CV20E-S, CV20ES-1320250, CV20E-S2, CV20ES2-1320290...(Other models you can see in the webshop)		

thermostats

bi-metal thermostats

bi-metal thermostats



GEV No.	375638	Ref. No.	6A046186 BN6A046186
description	bi-metal thermostat hole distance 23.5mm 1NC 1-pole connection F6.3 2 hole fixing		
For models:	CVP10E, CVP10E-1320700, CVP10E-2, CVP10E2-1320740, CVP10E2S-1320790, CVP10E-S, CVP10ES-1320750, CVP10E-S2, CVP10G, CVP10G-1310700, CVP10G-1310750, CVP10G-2, CVP10G2-1310740, CVP10GP-1310700, CVP10G-S, CVP10G-S2, CVP10GS2-1310790, CVP20E, CVP20E-1320800, CVP20E-2, CVP20E2-1320840, CVP20E-S, CVP20ES-1320850, CVP20E-S2, CVP20ES2-1320890, CVP20G, CVP20G-1310800, CVP20G-1310850, CVP20G-2, CVP20G-S, CVP20GS-1310840, CVP20G-S2, CVP20GS2-1310890, CVP21E, CVP21E-1322700, CVP21E-2, CVP21E-S, CVP21ES-1322750, CVP21E-S2, CVP21ES2-1322790, CVP21G, CVP21G-1312700, CVP21G-2, CVP21G2-1312740, CVP21G-S, CVP21GS-1312750, CVP21G-S2, CVP21GS2-1312790, CVP6E, CV-P6E-1320600...(Other models you can see in the webshop)		

control and safety thermostats

EGO

control thermostats

55.10/19_ series



GEV No.	375647	Ref. No.	6A046100 BN6A046100
description	thermostat t.max. 110°C temperature range 31-110°C 1-pole 1NO 16A probe ø 6mm probe L 133mm capillary pipe 870mm capillary pipe isolatedmm gland nut shaft ø 6x4.6mm shaft L 23mm shaft position upper rotation 318°		
For models:	TAC100-1022005, TAC101-1022006, TAC102-1022007, TAC130-1022105, TAC131-1022106, TAC132-1022107, TAC170-1022205, TAC171-1022206, TAC172-1022207, TAC6100-1622005, TAC6130-1622105, TAC6131-1622106, TAC6170-1622205		



GEV No.	375184	Ref. No.	1037102300
description	thermostat t.max. 298°C temperature range 55-294°C 1-pole 1NO 16A probe ø 3.1mm probe L 226mm capillary pipe 870mm capillary pipe isolated 350mm gland nut shaft L 23mm shaft position upper probe material SS		
For models:	CFE60, CFE60P, FOE60M, OCFE60, OCFE-60-12601005, OCFE-60-12601005MN, OCFGE61, OFOE60M, OFOE-60M-12601001		



GEV No.	375667	Ref. No.	R65070360
description	thermostat t.max. 300°C temperature range 68-300°C 1-pole 1NO 16A probe ø 3.1mm probe L 226mm capillary pipe 980mm capillary pipe isolated 980mm gland nut shaft ø 6x4.6mm shaft L 23mm shaft position upper rotation 318°		
For models:	CCE042M, CCE051M, CCE071M, CCE101M, CCE102M, CCG051M, CCG071M, CCG101M, CCG102M		



GEV No.	375002	Ref. No.	6A048800 9010
description	thermostat t.max. 320°C temperature range 55-320°C 1-pole 1NO 16A probe ø 3.1mm probe L 226mm capillary pipe 870mm capillary pipe isolated 850mm gland nut shaft L 23mm shaft position upper rotation 270°		
For models:	OLCX, OLFX, OLFX250E-1081151, OLFX250V-1081152, OLFX250V-1081153, OLFX380E-1081154, OLFX380E-1081155, OLFX380V-1081156, OLFX380V-1081157, OLFX420E-1081158, OLFX420E-1081159, OLFX420V-1081160, OLFX420V-1081161, OLFX540E-1081162, OLFX540E-1081163, OLFX540V-1081164, OLFX540V-1081165, OLFX600E-1081166, OLFX600E-1081167, OLFX600V-1081168, OLFX600V-1081169, OLFX680E-1081170, OLFX680E-1081171, OLFX680V-1081172, OLFX680V-1081173, OLFX780E-1081174, OLFX780E-1081175, OLFX780V-1081176, OLFX780V-1081177, OLFX900E-1081178, OLFX900E-1081179, OLFX900V-1081180, OLFX900V-1081181, WASHER-1081150		



GEV No.	375636	Ref. No.	6A046195 BN6A046195
description	thermostat t.max. 60°C temperature range fixed 60°C 1-pole 1CO 16A probe ø 1.1mm probe L 29mm capillary pipe 1470mm capillary pipe isolated 1450mm gland nut screw-in probe probe thread M14x1		
For models:	CMV6ES2-1320392, CVM10E, CVM10E-1320400, CVM10E-1320410, CVM10E-2, CVM10E2-1320440, CVM10E-S, CVM10E-S-1320450, CVM10E-S2, CVM10ES2-1320490, CVM10ES2-1320495, CVM10G, CVM10G-1310400, CVM10G-1310410, CVM10G-1310430, CVM10G-1310450, CVM10G-2, CVM10G2-1310440, CVM10GP-1310400, CVM10G-S, CVM10GS-1310460, CVM10G-S2, CVM10GS2-1310490, CVM10GS2-1310495, CVM20E, CVM20E-1320500, CVM20E-2, CVM20E2-1320540, CVM20E-S, CVM20ES-1320550, CVM20E-S2, CVM20ES2-1320590, CVM20G, CVM20G-1310500, CVM20G-2, CVM20G2-1310540, CVM20G-S, CVM20GS-1310550, CVM20G-S2, CVM20GS2-1310590, CVM21E, CVM21E-1322400, CVM21E-2, CVM21E2-1322440, CVM21E-S, CVM21ES-1322450, CVM21E-S2, CVM21ES2-1322490, CVM21ES2-1322495, CVM21G...(Other models you can see in the webshop)		

55.34_series



GEV No.	375192	Ref. No.	1309115
description	thermostat t.max. 300°C temperature range 50-300°C 3-pole 3NO 16A probe ø 3mm probe L 219mm capillary pipe 900mm capillary pipe isolatedmm gland nut shaft ø 6x4.6mm shaft L 23mm shaft position upper rotation 270°		
For models:	BRE40, BRE40D, BRE40DB, BRE40DG, BRE40DGB, BRE40G, FTE100B, FTE100BR, FTE100CRL, FTE40B, FTE40BR, FTE40C, FTE40D, FTE40DC, FTE60B, FTE60BR, FTE60C, FTE60D, FTE60DC, FTE60DR, FTE60DRCL, OBRE40, OBRE-40-12601110, OBRE-40-12601110MN, OFTE-100C-12601136, OFTE-100C-12601136MN, OFTE100CRL, OFTE-100CRL-12601138, OFTE40B, OFTE-40B-12601130, OFTE-40B-12601130MN, OFTE40BR, OFTE-40BR-12601132, OFTE-40BR-12601132MN, OFTE40C, OFTE-40C-12601135, OFTE-40C-12601135MN, OFTE60B, OFTE-60B-12601140, OFTE-60B-12601140MN, OFTE60BR, OFTE-60BR-12601141, OFTE-60BR-12601141MN, OFTE60BRR, OFTE-60BRR-12601142, OFTE-60BRR-12601142MN, OFTE60C, OFTE-60C-12601145, OFTE-60C-12601145MN		



GEV No.	375412	Ref. No.	6A038400 6A044600 BN6A044600
description	thermostat t.max. 320°C temperature range 50-320°C 3-pole 3NO 16A probe ø 3.1mm probe L 226mm capillary pipe 1480mm capillary pipe isolated 1400mm gland nut shaft ø 6x4.6mm shaft L 23mm shaft position upper rotation 318°		
For models:	40SEFT, 40SEFT-1825040, 40SEFT-1825045, 40SEFTC, 40SEFTC-1825045, 40SEFTR, 40SEFTR-1825041, 60SEFT, 60SEFT1-2R-1825051, 60SEFT1-3RIG-1825050, 60SEFT-1825050, 60SEFTC, 60SEFTC-1825050, 60SEFTR-1825052, 60SEFTRIG-1825050, 714CT-GVFE-1000180, 714CTGVFE-1000180, 714CT-GVFE-1000180R, 72-02FTE, 72-02FTE-12701130, 72-02FTER, 72-02FTER-12701132, 72-02TFTE, 72-02TFTE-12731130, 72-02TFTER, 72-02TFTER-12731132, 74-02FTE, 74-02FTE-12701140, 74-02FTE1-2R, 74-02FTE1-2R-12701141, 74-02FTER, 74-02FTER-12701142, 74-02TFTE, 74-02TFTE-12731140, 74-02TFTE-12731140MN, 74-02TFTE1-2R, 74-02TFTE1-2R-12731141, 74-02TFTER, 74-02TFTER-12731142, 741CE-1000405, 741CE-1000405R, 749CGVFE-1950059, 749CGVFE-1950059R, 74CE-000400, 74CE-1000400, 74CE-1000400R, 74FTE-000800, 74FT-E-1000800, 74FTE-1000800, 74FT-E-1000800R...(Other models you can see in the webshop)		



GEV No.	375383	Ref. No.	6A044900
description	thermostat t.max. 350°C temperature range 100-350°C 3-pole 3NO 16A probe ø 6mm probe L 75mm capillary pipe 870mm capillary pipe isolatedmm gland nut shaft ø 6x4.6mm shaft L 23mm shaft position upper rotation 270°		
For models:	40SEKB-1825200, 40SKE, 40SKE-1825200, FT-E940-1050510, FT-E940-1050511, FT-E980-1050520, FT-E980-1050521, FT-E980R1-2-1050522		



GEV No.	375380	Ref. No.	6A049405 BN6A049405
description	safety thermostat switch-off temp. 160°C 3-pole 20A probe ø 6mm probe L 89mm capillary pipe 900mm capillary pipe isolated 900mm gland nut probe SS		
For models:	40SECP, 40SECP-1825080, 40SECP-1825080E, 74-02NPEI, 74-02NPEI-12701755, 74-02NPGI, 7NP-GI50, 7PN-EI50, 911PEB-1192805, 911RPEB-1392890, 915PEB-1192800		

safety thermostats

55.10/19_series

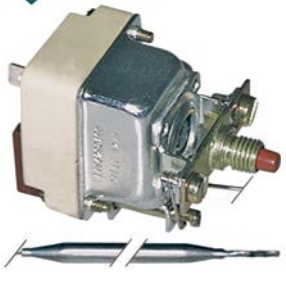

GEV No.	375285	Ref. No.	6A049500 BN6A049500
description	safety thermostat switch-off temp. 327°C 1-pole 1NC 16A probe ø 6mm probe L 77mm capillary pipe 870mm capillary pipe isolatedmm gland nut probe SS		
For models:	KB-E970-1050410, KB-E970A-1050411, KB-G970-1050450, KB-G970A-1050451		



GEV No.	375635	Ref. No.	6A046190 BN6A046190
description	safety thermostat switch-off temp. 300°C 1-pole 20A probe ø 11mm probe L 16mm capillary pipe 900mm capillary pipe isolated 900mm gland nut screw-in probe probe thread M14x1		
For models:	CV10E, CV10E-1320100, CV10E-2, CV10E2-1320140, CV10EB-1321100, CV10E-S, CV10ES-1320150, CV10E-S2, CV10ES2-1320190, CV10G, CV10G-1310100, CV10G-2, CV10G2-1310140, CV10GB-1311100, CV10G-S, CV10GS-1310150, CV10G-S2, CV10GS2-1310190, CV20E, CV20E-1320200, CV20E-2, CV20E2-1320240, CV20EB-1321200, CV20E-S, CV20ES-1320250, CV20E-S2, CV20ES2-1320290, CV20G, CV20G-1310200, CV20G-2, CV20G2-1310240, CV20GB-1311200, CV20G-S, CV20GS-1310250, CV20G-S2, CV20GS2-1310290, CV21E, CV21E-1322100, CV21E-2, CV21E2-1322140, CV21E-S, CV21ES-1322150, CV21E-S2, CV21ES2-1322190, CV21G, CV21G-1312100, CV21G-2, CV21G2-1312140, CV21G-S, CV21GS-1312150...(Other models you can see in the webshop)		

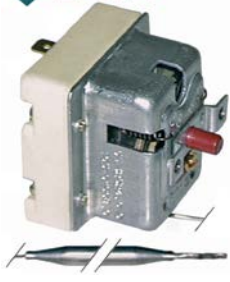

55.32_series



GEV No.	390159	Ref. No.	R65070081
description	safety thermostat switch-off temp. 150°C 1-pole 20A probe ø 6mm probe L 89mm capillary pipe 900mm capillary pipe isolated 800mm gland nut probe		
For models:	CKEP06B, CKEP10B, CKEP20B, CKEP21B, CKEP40B, CKET06B, CKET10B, CKET20B, CKET21B, CKET40B, CKGP06B, CKGP10B, CKGP20B, CKG-P21B, CKGP40B, CKGT06B, CKGT10B, CKGT20B, CKGT21B, CKGT40B		



GEV No.	375220	Ref. No.	LAR6507050
description	safety thermostat switch-off temp. 330°C 3-pole 20A probe ø 11mm probe L 18.5mm capillary pipe 900mm capillary pipe isolated 900mm gland nut probe screw-in probe probe thread M14x1		

1

GEV No.	375228	Ref. No.	6A046150 BN6A046150
description	safety thermostat switch-off temp. 350°C 3-pole 20A probe ø 3mm probe L 188mm capillary pipe 900mm capillary pipe isolated 900mm gland nut probe SS		
For models:	40SEFTC-1825045, 60SEFTC-1825055, 72-02CEPQ, 72-02CEPQ-12701201, 72-02CEPT, 72-02CEPT-12701001, 72-02CEPT-2212701001, 72-02FTEC, 72-02FTEC-12701135, 72-02TCEPQ, 72-02TCEPQ-12731201, 72-02TCEPT, 72-02TCEPT-12731001, 72-02TFTEC, 72-02TFTEC-12731135, 7-2FXE, 74-02CEEPO, 74-02CEEPO-12701210, 74-02CEEPT, 74-02CEEPT-12701010, 74-02CEPQ, 74-02CEPQ-12701202, 74-02CEPT, 74-02CEPT-12701002, 74-02CGE, 74-02CGE-12700011, 74-02CGE-12700011TA, 74-02CTEE, 74-02CTEE-12701180, 74-02CTGE, 74-02CTGE-12700190, 74-02CTGE-12700190TA, 74-02TCEPQ, 74-02TCEPQ-12731202, 74-02TCEPT, 74-02TCEPT-12731002, 74-02VTCEV, 74-02VTCEV, 74-02VTCEV-12701020, 74CE-000400, 74FT-EC-1000805, 74FT-EC-1000805R, 74TFTEC-1009805, 74TFTEC-1009805R, 76-02CEEANPQ, 76-02CEEANPT, 76-02CEEACAPQ, 76-02CEEACAPT, 76-02CEEAPQ-12701216, 76-02CEEAPT-12701016...(Other models you can see in the webshop)		



1

GEV No.	375684	Ref. No.	LA65070350 LAR65070350
description	safety thermostat switch-off temp. 360°C 1-pole 20A probe ø 11mm probe L 16mm capillary pipe 900mm capillary pipe isolated 900mm gland nut probe screw-in probe probe thread M14x1		
For models:	CCE042M, CCE051M, CCE071M, CCE101M, CCE102M, CCG051M, CCG071M, CCG101M, CCG102M, CKEP06, CKEP06B, CKEP10, CKEP10B, CKEP20, CKEP20B, CKEP21, CKEP21B, CKEP40, CKEP40B, CKET06, CKET06B, CKET10, CKET10B, CKET20, CKET20B, CKET21, CKET21B, CKET40, CKET40B, CKGP06, CKGP06B, CKGP10, CKGP10B, CKGP20, CKGP20B, CKGP21, CKGP21B, CKGP40, CKGP40B, CKGT06, CKGT06B, CKGT10B, CKGT20, CKGT20B, CKGT21, CKGT21B, CKGT40, CKGT40B		

various

safety thermostats



1

GEV No.	375637	Ref. No.	6A046185 BN6A046185
description	safety thermostat switch-off temp. 135°C temperature range°C 1-pole 1NC 16A probe ø 6mm probe L 75mm capillary pipe 600mm capillary pipe isolatedmm gland nut shaft ømm probe copper 250V		
For models:	CVP10E, CVP10E-1320700, CVP10E-2, CVP10E2-1320740, CVP10E2S-1320790, CVP10E-S, CVP10ES-1320750, CVP10E-S2, CVP10G, CVP10G-1310700, CVP10G-1310750, CVP10G-2, CVP10G2-1310740, CVP10GP-1310700, CVP10G-S, CVP10G-S2, CVP10GS2-1310790, CVP20E, CVP20E-1320800, CVP20E-2, CVP20E2-1320840, CVP20E-S, CVP20ES-1320850, CVP20E-S2, CVP20ES2-1320890, CVP20G, CVP20G-1310800, CVP20G-1310850, CVP20G-2, CVP20G-S, CVP20GS-1310840, CVP20G-S2, CVP20GS2-1310890, CVP21G, CVP21G-1312700, CVP21G-2, CVP21G2-1312740, CVP21G-S, CVP21GS-1312750, CVP21G-S2, CVP21GS2-1312790, CVP6E, CVP6E-1320600, CVP6E-2, CVP6E2-1320640, CVP6E-S, CVP6ES-1320650, CVP6E-S2, CVP6ES2-1320690, CVP6G...(Other models you can see in the webshop)		

accessories

gland nut accessories

bolts with slot



1

GEV No.	520243	Ref. No.	6A038801 BN6A038801	
description	bolt with slot thread M9x1 Qty 10 pcs nickel-plated brass			
For models:	40SEFR2S-1826140, 40SGFR-1826160, 40SGFR2S-1826160, 55-45FRG, 55-90FRG, 60SEFR2S-1826150, 60SGFR-1826170, 60SGFR2S-1826170, 72-02FRG, 72-02FRG-12700500, 72-02FRG17-12700505, 73-02FRG, 73-02FRG-12700550, 74-02FRG, 74-02FRG-12700600, 74-02FRG17-12700605, 7FRI-G415, 7FRI-G610, 7FRI-G815, 9122PFRG-1103930, 914PFRTE-1204940, 92-04FRG15L, 92-04FRG15L-12900510, 92-04FRG17L-12900515, 92-04FRG20L, 92-04FRG20L-12900500, 92-04FRG20L-12900500TA, 922FRG-1191930, 922RFRG-1391930, 93-04FRG, 93-04FRG-12900550, 93-04FRG-12900550H, 94-04FRG-12900600, 94-04FRG20L, 94-04FRG20L-12900600TA, 94-04FRG23L-12900605, 9FRI-G415, 9FRI-G610, 9FRI-G815, FR-E925N-1050730, FR-E950N-1050732, FR-G925N-1050731, FR-G950N-1050733			
accessories for	520243			
	GEV No.	510591	Ref. No.	—
	washer with slot ED ø 8.8mm slit width 1.2mm Qty 10			
	GEV No.	510592	Ref. No.	—
	gasket ø 8x8.7mm Qty 10 pcs slotted silicone			



connecting bows



GEV No.	550060	Ref. No.	1988500 6A045900 921200 BN6A045900
description	connecting bow long for thermostat Qty 1 pcs		
For models:	40SEC, 40SEC-1825060, 60SEC, 60SEC-1825070, 61FE-1826050, 61SCGF3S-1826055, 61SCGF4S-1827055, 61SECFE-1826075, 72-02CBE-12701150, 72-02CG, 72-02CG-12700001, 72-02CG-12700001TA, 72-02FRE, 72-02FRE-12701500, 72-02TCBE-12731150, 72-02TCG-12730001, 72-02TCG-12730001TA, 72-02TGC, 725KB-E-1000200, 725KB-E-1000200R, 725KB-EB-1000201, 725KB-EB-1000201R, 725KB-EM-1000210R, 725KB-EMB-1000211, 74-02CG, 74-02CG-12700002, 74-02CG-12700002TA, 74-02CGE, 74-02CGE-12700011, 74-02CGE-12700011TA, 74-02CGG, 74-02CGG-12700010, 74-02CGG-12700010TA, 74-02FRE, 74-02FRE-12701600, 74-02KBEB-12701110, 74-02KBEBI-12701115, 74-02KBEMB-12701120, 74-02KBEMBI-12701125, 74-02KBGB, 74-02KBGB-12700110, 74-02KBGBI, 74-02KBGBI-12700115, 74-02KBGMB, 74-02KBGMB-12700120, 74-02KBGMBI, 74-02KBGMBI-12700125, 74-02TCG-12730002, 74-02TCG-12730002TA, 74-02TGC...(Other models you can see in the webshop)		



GEV No.	550059	Ref. No.	6A045000
description	connecting bow short for switch Qty 1 pcs		
For models:	40SEBM2S-1826100, 40SEC-1825060, 40SECP-1825080, 40SECP-1825080E, 40SEFR, 40SEFR-1826140, 40SEFR2S-1826140, 40SEFT-1825040, 40SEFTC-1825045, 40SEFTR-1825041, 40SEKB-1825200, 41SEFR-1826120, 41SEFR2S-1826120, 421SEFR-1826125, 60SEBM-1826110, 60SEBM2S-1826110, 60SEC-1825070, 60SEFR, 60SEFR-1826150, 60SEFR2S-1826150, 60SEFT1-2R-1825051, 60SEFT-1825050, 60SEFTC-1825055, 60SEFTR-1825052, 61SEFR-1826130, 61SEFR2S-1826130, 621SEFR-1826135, 7101FR-E-1077750R, 7121FR-E-1077950R, 714CT-GVFE-1000180, 714CT-GVFE-1000180R, 7201FR-E-1077850R, 72-02CBE, 72-02CBE-12701150, 72-02CPE, 72-02CPE-12701900, 72-02FTE, 72-02FTE-12701130, 72-02FTEC, 72-02FTEC-12701135, 72-02FTEC, 72-02FTEC-12701132, 72-02TCBE, 72-02TCBE-12731150, 72-02TFTE, 72-02TFTE-12731130, 72-02TFTEC, 72-02TFTEC-12731135, 72-02TFTEC, 72-02TFTEC-12731132...(Other models you can see in the webshop)		

push/momentary push switches

30x22mm



GEV No.	301086	Ref. No.	6A038550 BN6A038550
description	push switch mounting measurements 30x22mm black 2NO 250V 12A 0-1 connection male faston 6.3mm ambient temperature max. 85/55°C protection IP54 with protective collar		
For models:	ECVM10ES2, ECVM10ES2-1324290, ECVM10ES2-1324290MN, ECVM10ES2-1326120, ECVM10GS2, ECVM10GS2-1314290, ECVM10GS2-1316120, ECVM20ES2, ECVM20ES2-1324390, ECVM20ES2-1326140, ECVM20GS2, ECVM20GS2-1314390, ECVM20GS2-1316140, ECVM21ES2, ECVM21ES2-1324490, ECVM21ES2-1326160, ECVM21GS2-1314490, ECVM21GS2-1316160, ECVM6ES2, ECVM6ES2-1324190, ECVM6ES2-1326100, ECVM6ES2-1326100H, ECVM6GS2, ECVM6GS2-1314190, ECVM6GS2-1316100, ECVP10ES2, ECVP10ES2-1324690, ECVP10ES2-1326200, ECVP10GS2, ECVP10GS2-1314690, ECVP10GS2-1316200, ECVP20ES2, ECVP20ES2-1324790, ECVP20ES2-1326220, ECVP20GS2, ECVP20GS2-1314790, ECVP20GS2-1316220, ECVP21ES2, ECVP21ES2-1324890, ECVP21ES2-1326240, ECVP21GS2, ECVP21GS2-1314890, ECVP21GS2-1316240, ECVP6ES2, ECVP6ES2-1324590, ECVP6ES2-1326180, ECVP6GS2, ECVP6GS2-1314590, ECVP6GS2-1316180		

ø16mm



GEV No.	301172	Ref. No.	R65260610
description	momentary push switch mounting ø 16mm black 1NO 250V 16A connection male faston 6.3mm protection IP40 ambient temperature max. 150°C		
For models:	CCE042M, CCE051M, CCE071M, CCE101M, CCE102M, CCG051M, CCG071M, CCG101M, CCG102M		



GEV No.	301227	Ref. No.	R65260600
description	push switch mounting ø 16mm black 1NO 250V 16A connection male faston 6.3mm protection IP40 ambient temperature max. 150°C		
For models:	CCE042M, CCE051M, CCE071M, CCE101M, CCE102M, CCG051M, CCG071M, CCG101M, CCG102M		

ø25mm



GEV No.	345162 ¹	Ref. No.	826630200
description	push switch mounting ø 25mm yellow 2NO 250V 16A illuminated connection male faston 6.3mm ambient temperature max. 85°C protection IP40		

¹illuminated

switches and momentary switches

rocker/momentary rocker switches

30x22mm





GEV No.	301017	Ref. No.	21110299 MA21110299
description	rocker switch mounting measurements 30x22mm green 2CO 250V 16A illuminated connection male faston 6.3mm ambient temperature max. 125/55°C protection IP40		

accessories for 301017



GEV No.	301036	Ref. No.	—
protective cover internal size 30x22mm for rocker switch mounting measurementsmm			



			
1			
GEV No.	346318	Ref. No.	BN826630050
description	momentary push switch mounting ø 25mm red 1NO 250V 16A with cover cap ignition connection male faston 6.3mm ambient temperature max. 85°C protection IP65		
accessories for	346318		
		GEV No.	345039
		Ref. No.	41826630420 826630060
description	protective cover round ED ø 33mm external size 23mm internal size 21mm H 12mm clear mounting ø 25mm		

			
1			
GEV No.	345039	Ref. No.	41826630420 826630060
description	protective cover round ED ø 33mm external size 23mm internal size 21mm H 12mm clear mounting ø 25mm		
For models:	7CP-G400, 7CP-G800, 7PCF-G120, 7PCF-G121, 7PCF-G160, 7PCF-G161, 7PCF-G800, 7PCF-G811, 9BR-G125, 9CP-G400, 9CP-G800, 9FRI-G415, 9FRI-G610, 9FRI-G815, 9GL-G400, 9GL-G800, 9TGL-G400, 9TGL-G800		
accessories for	345039		
		GEV No.	345001
		Ref. No.	—
description	momentary push switch mounting ø 25mm yellow 1NO/indicator light 250V 16A cover connection male faston 6.3mm ambient temperature max. 85°C protection IP65		

<h3>2 hole fixing</h3>			
			
1			
GEV No.	346359	Ref. No.	3108870 BN3108870
description	momentary push switch connection cable ambient temperature max. 85°C protection IP40 door contact switch		
For models:	CV10E, CV10E-1320100, CV10E-2, CV10E2-1320140, CV10E-S, CV10ES-1320150, CV10E-S2, CV10ES2-1320190, CV10G, CV10G-1310100, CV10G-2, CV10G2-1310140, CV10G-S, CV10GS-1310150, CV10G-S2, CV10GS2-1310190, CV20E, CV20E-1320200, CV20E-2, CV20E2-1320240, CV20E-S, CV20ES-1320250, CV20E-S2, CV20ES2-1320290, CV20G, CV20G-1310200, CV20G-2, CV20G2-1310240, CV20G-S, CV20GS-1310250, CV20G-S2, CV20GS2-1310290, CV21E, CV21E-1322100, CV21E-2, CV21E2-1322140, CV21E-S, CV21ES-1322150, CV21E-S2, CV21ES2-1322190, CV21G, CV21G-1312100, CV21G-2, CV21G2-1312140, CV21G-S, CV21GS-1312150, CV21G-S2, CV21GS2-1312190, CV6E, CV6E-1320000...(Other models you can see in the webshop)		

accessories

blank elements

			
1			
GEV No.	346353	Ref. No.	3102870 BN3102870
description	dummy element		
For models:	CV10E, CV10E-1320100, CV10E-1320110, CV10E-2, CV10E2-1320140, CV10EB-1321100, CV10E-S, CV10ES-1320150, CV10E-S2, CV10ES2-1320190, CV10G, CV10G-1310100, CV10G-2, CV10G2-1310140, CV10GB-1311100, CV10G-S, CV10GS-1310150, CV10G-S2, CV10GS2-1310190, CV20E, CV20E-1320200, CV20E-2, CV20E2-1320240, CV20EB-1321200, CV20E-S, CV20ES-1320250, CV20E-S2, CV20ES2-1320290, CV20G, CV20G-1310200, CV20G-2, CV20G2-1310240, CV20GB-1311200, CV20G-S, CV20GS-1310250, CV20G-S2, CV20GS2-1310290, CV21E-1322100, CV21E2-1322140, CV21G-1312100, CV21G2-1312140, CV6E, CV6E-1320000, CV6E-1320010, CV6E-1320050, CV6E-2, CV6E2-1320040, CV6EB-1321000, CV6E-S, CV6E-S2...(Other models you can see in the webshop)		

microswitches

lever actuated

			
1			
GEV No.	345044	Ref. No.	164602
description	microswitch with lever 250V 16A 1CO connection male faston 6.3mm ambient temperature max. 85°C mounting distance 25mm type C99ZP3 actuating force: 25g lever length 71mm		
For models:	KBT40-21091640, KC41-210916400BDC, KR41-210906400BFA, KTN40-21090640		



pin-plunger actuated

M10



GEV No.	345032	Ref. No.	6A039800 BN6A039800 R65260540
description	microswitch with plunger thread M10x1 thread L 12mm 250V 16A 1CO connection male faston 6.3mm stroke 7mm mounting distance 22mm L 28mm ambient temperature max. 125°C type SP9603 actuating force: 180g		
For models:	41SEFR, 41SEFR-1826120, 41SEFR2S-1826120, 421SEFR-1826125, 55-45FRE, 55-90FRE, 61SEFR, 61SEFR-1826130, 61SEFR2S-1826130, 621SEFR-1826135, 7101FR-E-1077750R, 710FRE-1077700, 7121FR-E-1077950R, 712FRE-1077900, 7201FR-E-1077850R, 72-02FRE, 72-02FRE-12701500, 72-02FREM, 72-02FREM-12701530, 720FRE-1077800, 7221FR-E-1078050R, 722FRE-1078000, 725KBEM-000200, 725KBEM-1000210, 725KB-EM-1000210R, 725KB-EMB-1000211, 725KBEMB-1000211, 73-02FRE, 73-02FRE-12701550, 73-02FREM, 73-02FREM-12701580, 74-02FRE, 74-02FRE-12701600, 74-02FREM, 74-02FREM-12701630, 74-02KBEB, 74-02KBEB-12701110, 74-02KBEBI, 74-02KBEBI-12701115, 74-02KBEMB, 74-02KBEMB-12701120, 74-02KBEMBI, 74-02KBEMBI-12701125, 74-02KBEMBI-12701125HB, 74-02KBGB, 74-02KBGB-12700110, 74-02KBGBI, 74-02KBGBI-12700115, 74-02KBGMB, 74-02KBGMB-12700120...(Other models you can see in the webshop)		

system switches (ROLD)



GEV No.	345601	Ref. No.	15827
description	indicator lamp holder V ø 11mm		
For models:	OLDS35-Neutra, OLDS37-Neutra, OLDS40-Neutra, OLDS50-Neutra, OLG35-Neutra, OLG537-Neutra, OLG540, OLG540-Neutra, OLG550E-COD-1081015, OLG550-Neutra, OLG585-Neutra, OLHT-11-Neutra, OLHT11S-Neutra, OLHT12S-Neutra, OLLP1-800-Neutra		



GEV No.	347193	Ref. No.	15813
description	momentary switch unit 1NO 250V 16A connection male faston 6.3mm		
For models:	OLDerby, OLDS35, OLDS35-1081005, OLDS35-1081061, OLDS35D-1081062, OLDS35-Neutra, OLDS37, OLDS37-1081006, OLDS37-1081063, OLDS37D-1081007, OLDS37D-1081064, OLDS37LS-1081008, OLDS37LSD-1081009, OLDS37-Neutra, OLDS40, OLDS40-1081010, OLDS40-1081065, OLDS40D-1081011, OLDS40D-1081066, OLDS40E-1081067, OLDS40ED-1081068, OLDS40LS-1081012, OLDS40LSD-1081013, OLDS40-Neutra, OLDS45, OLDS50, OLDS50-1081088, OLDS50D-1081089, OLDS50E-1081090, OLDS50ED-1081091, OLDS50-Neutra, OLDS50P-1081018, OLDS50PD-1081019, OLG35, OLG35-1080702, OLG35D-1081000, OLG35-Neutra, OLG600, OLGastro450, OLGastro500Plus, OLGastro500S, OLGastro750Plus, OLGastro750S, OLG537, OLG537-1080700, OLG537D-1080707, OLG537LS-1081001, OLG537LSD-1081002, OLG537-Neutra, OLG540...(Other models you can see in the webshop)		



GEV No.	345606	Ref. No.	15811/A
description	momentary switch unit 2CO 250V 16A connection male faston 6.3mm		
For models:	OLDS40, OLDS40-1081010, OLDS40-1081065, OLDS40D-1081011, OLDS40D-1081066, OLDS40E-1081067, OLDS40ED-1081068, OLDS40LS-1081012, OLDS40LSD-1081013, OLDS50-Neutra, OLDS50P-1081018, OLDS50PD-1081019, OLGastro500Plus, OLGastro500S, OLGastro750Plus, OLGastro750S, OLG540, OLG540, OLG540-1080701, OLG540D-1080708, OLG540D-1081003, OLG545, OLG545LSD-1081004, OLG550, OLG550-1080705, OLG550D-1080706, OLG550E-1080730, OLG550ECO-1081014, OLG550ECOD-1081015, OLG550ED-1080731, OLG550-Neutra, OLG585, OLG585-1081016, OLG585D-1081017, OLHT11-1081071, OLHT11D-1081072, OLHT11ECO-1081070, OLHT-11-Neutra, OLHT11S, OLHT11S-Neutra, OLHT12S-Neutra, OLLinear, OLLP1-800, OLLP1-800-1080721, OLLP1-800EL, OLLP1-800-Neutra, OLLP1-S8, OLLP1-S8EL, OLLP-ZERO, OLLPZERO-1081057		



GEV No.	345539	Ref. No.	84001
description	push button size 17x13mm grey		
For models:	OLDS35-Neutra, OLDS37-Neutra, OLDS40-Neutra, OLDS50-Neutra, OLG35-Neutra, OLG537-Neutra, OLG540-Neutra, OLG550E-COD-1081015, OLG550-Neutra, OLHT11S-Neutra, OLHT12S-Neutra		



GEV No.	345605	Ref. No.	15811
description	switch 2CO 250V 16A connection male faston 6.3mm		
For models:	OLDS35, OLDS35-1081061, OLDS35D-1081062, OLDS35-Neutra, OLDS37, OLDS37-1081006, OLDS37-1081063, OLDS37D-1081007, OLDS37D-1081064, OLDS37LS-1081008, OLDS37LSD-1081009, OLDS37-Neutra, OLDS40, OLDS40-1081010, OLDS40-1081065, OLDS40D-1081011, OLDS40D-1081066, OLDS40E-1081067, OLDS40ED-1081068, OLDS40LS-1081012, OLDS40LSD-1081013, OLDS40-Neutra, OLDS45, OLDS50-Neutra, OLDS50P-1081018, OLDS50PD-1081019, OLG35, OLG35-1080702, OLG35D-1081000, OLG35-Neutra, OLGastro500Plus, OLGastro500S, OLGastro750Plus, OLGastro750S, OLG537, OLG537-1080700, OLG537D-1080707, OLG537LS-1081001, OLG537LSD-1081002, OLG537-Neutra, OLG540, OLG540, OLG540-1080701, OLG540D-1080708, OLG540D-1081003, OLG545, OLG545LSD-1081004, OLG550, OLG550-1080705, OLG550D-1080706, OLG550E-1080730, OLG550ECO-1081014...(Other models you can see in the webshop)		



			
1			
GEV No.	345720	Ref. No.	15812
description	switch 2NO 250V 16A connection male faston 6.3mm		
For models:	OLAX151, OLAX151EDX-1080725, OLAX151ELEFT-1080727, OLAX151-highspeed, OLAX160, OLAX160E-1080750, OLAX160E-1080751, OLAX160V-1080755, OLAX160V-1080756, OLAX160V-1081031, OLAX160V-1081032, OLAX210, OLAX210E-1081029, OLAX210E-1081030, OLAX220, OLAX220E-1080787, OLAX220E-1080788, OLAX220V-1080789, OLAX220V-1080790, OLAX230, OLAX230E-1080791, OLAX230E-1080792, OLAX230V-1080793, OLAX230V-1080794, OLAX240, OLAX240E-1080795, OLAX240E-1080796, OLAX240V-1080797, OLAX240V-1080798, OLAX250, OLAX250E-1080760, OLAX250E-1080761, OLAX250V-1080765, OLAX250V-1080766, OLAX300, OLAX300E-1080770, OLAX300E-1080771, OLAX300E-1081033, OLAX300E-1081035, OLAX300E-1081036, OLAX300LC, OLAX300LCE-1081034, OLAX300V-1080775, OLAX300V-1080776, OLAX310, OLAX310E-1081110, OLAX310E-1081111, OLAX310LC, OLAX310LCE-1081114, OLAX310LCE-1081115...(Other models you can see in the webshop)		

4-position			
			
1			
GEV No.	300104	Ref. No.	6A038300 BN6A038300
description	cam switch 4 operating positions 3NO/1CO sequence 0-1-2-3 32A shaft ø 6x4.6mm shaft L 23mm connection screw ceramic		

cam switches

on/off

			
1			
GEV No.	300020	Ref. No.	6A049300 BN6A049300
description	cam switch 4 operating positions 2NO sequence 0-1-0-1 16A shaft ø 6x4.6mm shaft L 23mm connection screw ceramic		
For models:	40SECC, 40SECC-1826260, 72-02FREM, 72-02FREM-12701530, 72-02KBEF, 72-02KBEF-12701127, 72-02SPE-12701700, 725KBEM-000200, 725KB-G-1000110, 725KBG-1000110, 725KB-G-1000110R, 725KB-GB-1000111, 725KB-GB-1000111R, 725KBGM-000120, 725KB-GM-1000120, 725KB-GM-1000120R, 725KB-GMB-1000121, 725KB-GMB-1000121R, 74-02FREM, 74-02FREM-12701630, 74-02KBEF, 74-02KBEF-12701128, FR-E925N-1050730, FR-E950N-1050732, KB-E970-1050410, KBE970-1050410, KB-E970A-1050411, KB-G970-1050450, KB-G970A-1050451		
accessories for	300020		
	GEV No.	110135	Ref. No. —
rosette knob up to ø 52mm			
	GEV No.	110231	Ref. No. —
knob switch 0-1-0-1 t.max.°Cø 50mm shaft ø 6x4.6mm shaft flat upper black			

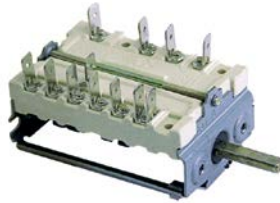
4 operating positions			
			
1			
GEV No.	300010	Ref. No.	R65080010
description	cam switch 4 operating positions 2NO/2CO sequence 0-1-2-3 16A shaft ø 6x4.6mm shaft L 23mm connection male faston 6.3mm ceramic		
For models:	CCE042M, CCE051M, CCE071M, CCE101M, CCE102M, CCG051M, CCG071M, CCG101M, CCG102M		

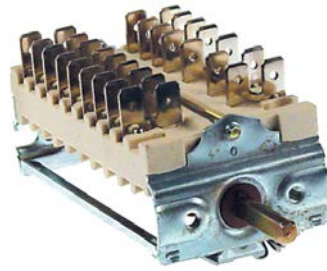
5 operating positions			
			
1			
GEV No.	346352	Ref. No.	6A046015 BN6A046015
description	cam switch 5 operating positions 5NO/2CO sequence 1-0-2-3-4 16A shaft ø 6x4.6mm shaft L 23mm connection male faston 6.3mm ceramic		
For models:	CV10E, CV10E-1320100, CV10E-2, CV10E2-1320140, CV10EB-1321100, CV10E-S, CV10ES-1320150, CV10E-S2, CV10ES2-1320190, CV10G, CV10G-1310100, CV10G-2, CV10G2-1310140, CV10GB-1311100, CV10G-S, CV10GS-1310150, CV10G-S2, CV10GS2-1310190, CV20E, CV20E-1320200, CV20E-2, CV20E2-1320240, CV20EB-1321200, CV20E-S, CV20ES-1320250, CV20E-S2, CV20ES2-1320290, CV20G, CV20G-1310200, CV20G-2, CV20G2-1310240, CV20GB-1311200, CV20G-S, CV20GS-1310250, CV20G-S2, CV20GS2-1310290, CV21E, CV21E-1322100, CV21E-2, CV21E2-1322140, CV21E-S, CV21ES-1322150, CV21E-S2, CV21ES2-1322190, CV21G, CV21G-1312100, CV21G-2, CV21G2-1312140, CV21G-S, CV21GS-1312150...(Other models you can see in the webshop)		



operation switches



GEV No.	300002	Ref. No.	6A046001 BN6A046001
description	cam switch 2 operating positions 4NO 16A sequence 0-1 shaft ø 6x4.6mm shaft L 23mm connection male faston 6.3mm ceramic		
For models:	110-135CGE, 110-135CGE2P, 110-135CGEE, 110-135CGEE2P, 110-135CGEEP, 110-135CGEP, 110-90CGE, 110-90CGE1P, 110-90CGEP, 110-90CTEE, 110-90CTGE, 110-90FTEE, 110-90FTTE, 40SEC-1825060, 40SECP, 40SECP-1825080, 40SECP-1825080E, 40SEFR, 40SEFR-1826140, 40SEFR2S-1826140, 40SEFT, 40SEFT-1825040, 40SEFT-1825045, 40SEFTC, 40SEFTC-1825045, 40SEFTR, 40SEFTR-1825041, 41SEFR, 41SEFR-1826120, 41SEFR2S-1826120, 421SEFR-1826125, 55-45CPE, 55-90CPE, 60SEC-1825070, 60SEFR, 60SEFR-1826150, 60SEFR2S-1826150, 60SEFT, 60SEFT1-2R-1825051, 60SEFT1-3RIG-1825050, 60SEFT-1825050, 60SEFTC, 60SEFTC-1825050, 60SEFTC-1825055, 60SEFTR-1825052, 60SEFTRIG-1825050, 61SECFE-1826075, 61SEFR, 61SEFR-1826130, 61SEFR2S-1826130...(Other models you can see in the webshop)		



GEV No.	300080	Ref. No.	6A044800 710300 MA710300
description	cam switch 2 operating positions 4NO 16A sequence 0-1 shaft ø 6x4.6mm shaft L 23mm connection screw operation switch ceramic ambient temperature max. 150°C		
For models:	40SEBM, 40SEBM-1826100, 40SECP, 40SEKB-1825200, 40SKE, 40SKE-1825200, 60SEBM, 60SEBM-1826110, 72-02FRGM, 72-02FRGM-12700530, 72-02FRGM-12700530TA, 73-02FRGM, 73-02FRGM-12700580, 73-02FRGM-12700580TA, 74-02FRGM, 74-02FRGM-12700630, BRE40, BRE40D, BRE40DB, BRE40DG, BRE40DGB, BRE40G, CFE60, CFE60P, FTE100B, FTE100BR, FTE100CRL, FTE40B, FTE40BR, FTE40C, FTE40D, FTE40DC, FTE60B, FTE60BR, FTE60C, FTE60D, FTE60DC, FTE60DR, FTE60DRCL, OBRE40, OBRE-40-12601110, OBRE-40-12601110MN, OCFE60, OCFE-60-12601005, OCFE-60-12601005MN, OCFGE61, OFTE-100C-12601136, OFTE-100C-12601136MN, OFTE100CRL, OFTE-100CRL-12601138...(Other models you can see in the webshop)		
accessories for	300080		
	GEV No.	551456	Ref. No. —
	gasket for switch ED ø 14mm ID ø 2.5mm thickness 3.5mm white		



GEV No.	300200	Ref. No.	1037313200 6A046000 MA1037313200
description	operation switch 2 operating positions 2NO 16A sequence 0-1 shaft ø 6x4.6mm shaft L 23mm connection male faston 6.3mm operation switch ceramic		
For models:	110-90FTE, 110-90FTE1-2R, 110-90FTEC, 110-90FTEC1-2R, 110-90FTECR, 110-90FTEE, 110-90FTEE, 110-90FTECR, 110-90FTTE, 110-90FTTE1-2R, 110-90FTTEC, 110-90FTTEC1-2R, 110-90FTTECR, 110-90FTTER, 40SEC, 40SEC-1825060, 40SEFT-1825040, 55-45FRE, 55-90FRE, 60SEC, 60SEC-1825070, 61FE-1826050, 61SCGFE3S-1826055, 61SCGFE4S-1827055, 61SECFE-1826075, 710FRE-1077700, 72-02CBE-12701150, 72-02FRE, 72-02FRE-12701500, 72-02TCBE-12731150, 720FRE-1077800, 722FRE-1078000, 725KB-E-1000200, 725KBE-1000200, 725KB-E-1000200R, 725KB-EB-1000201, 725KBEB-1000201, 725KB-EB-1000201R, 725KBEM-1000210, 725KB-EM-1000210R, 725KB-EMB-1000211, 725KBEMB-1000211, 74-02FRE, 74-02FRE-12701600, 74-02KBEB, 74-02KBEB-12701110, 74-02KBEBI, 74-02KBEBI-12701115, 74-02KBEMB, 74-02KBEMB-12701120, 74-02KBEMBI...(Other models you can see in the webshop)		

touch sensitive light switches



GEV No.	346388	Ref. No.	R65260750
description	touch sensitive light switch 1NOVA for combi-steamer L 47mm W 20mm H 30mm		
For models:	CCE071M, CCE101M, CCE102M, CCG071M, CCG101M, CCG102M, CKEP06, CKEP06B, CKEP10, CKEP10B, CKEP20, CKEP20B, CKEP21, CKEP21B, CKEP40, CKEP40B, CKET06, CKET06B, CKET10, CKET10B, CKET20, CKET20B, CKET21, CKET21B, CKET40, CKET40B, CKGP06, CKGP06B, CKGP10, CKGP10B, CKGP20, CKGP20B, CKGP21, CKGP21B, CKGP40, CKGP40B, CKGT06, CKGT06B, CKGT10, CKGT10B, CKGT20B, CKGT21, CKGT21B, CKGT40, CKGT40B		



magnetic switches

36x13mm

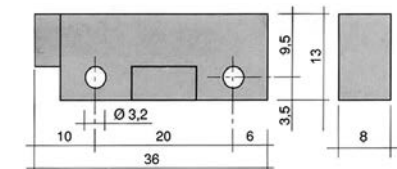

GEV No.	345335	Ref. No.	5169100 995405 MA5169100
description	magnetic switch L 36mm W 13mm 1NO 250V 0.04A P max. 10W connection cable cable length 960mm		
For models:	031, 051, 081, 121, 161, BBC051DF-ASX-4186V21A286220, BBF031AF-ASX-4186V204286210, KBC051-20354051, KBC151-20354151, KBC201-20355201, KBC201-PASS-THROUGH-20355221, KBC202-20355202, KBC202-PASS-THROUGH-20355222, KBF051T-20363050, KRC201-20358201, KRC202-20358202, OBC051DF-ASX-6V21A-286220OL, OBC081AF-ASX-6V221285220OL, OBC121DF-ASX-6V23A-285220OL, OBC161DF-ASX-6V24A485220OL, OBF031AF-ASX-6V204286210OL, OLBFO51-20364051OL, OLBFO51T-20363050OL, OLBFO51-20364151OL, OLBFO201-20365201OL, OLBFO201-20365221OL, OLBFO202-20365202OL, OLBFO202-20365222OL, OLRFO201-20368201OL, OLRFO202-20368202OL		
accessories for	345335		
	GEV No.	519049	Ref. No. —
	magnet \varnothing mm L 63mm H 10.7mm W 18.8mm hole distance 52mm M2 hole \varnothing 2mm		

37x16mm



GEV No.	347790	Ref. No.	LAR65265100
description	magnetic switch L 37mm W 16mm 1NO 250V connection cable cable length 1960mm 10W with magnet nominal 0.04A		
For models:	CKEP06, CKEP06B, CKEP10, CKEP10B, CKEP20, CKEP20B, CKEP21, CKEP21B, CKEP40, CKEP40B, CKET06, CKET06B, CKET10, CKET10B, CKET20, CKET20B, CKET21, CKET21B, CKET40, CKET40B, CKGP06, CKGP06B, CKGP10, CKGP10B, CKGP20, CKGP20B, CKGP21, CKGP21B, CKGP40, CKGP40B, CKGT06, CKGT06B, CKGT10B, CKGT20, CKGT20B, CKGT21, CKGT21B, CKGT40, CKGT40B		

40x13mm

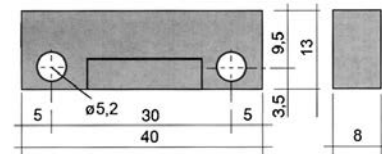

GEV No.	346351	Ref. No.	6A047085 BN6A047085
description	magnetic switch L 40mm W 13mm 1NO 250V 0.04A P max. 10W connection cable cable length 650mm		
For models:	CMV6ES2-1320392, CV10E, CV10E-1320100, CV10E-1320110, CV10E-2, CV10E2-1320140, CV10EB-1321100, CV10E-S, CV10ES-1320150, CV10E-S2, CV10ES2-1320190, CV10G, CV10G-1310100, CV10G-2, CV10G2-1310140, CV10GB-1311100, CV10G-S, CV10GS-1310150, CV10G-S2, CV10GS2-1310190, CV20E, CV20E-1320200, CV20E-2, CV20E2-1320240, CV20EB-1321200, CV20E-S, CV20ES-1320250, CV20E-S2, CV20ES2-1320290, CV20G, CV20G-1310200, CV20G-2, CV20G2-1310240, CV20GB-1311200, CV20G-S, CV20GS-1310250, CV20G-S2, CV20GS2-1310290, CV21E, CV21E-1322100, CV21E-2, CV21E2-1322140, CV21E-S, CV21ES-1322150, CV21E-S2, CV21ES2-1322190, CV21G, CV21G-1312100, CV21G-2, CV21G2-1312140...(Other models you can see in the webshop)		

65x20mm

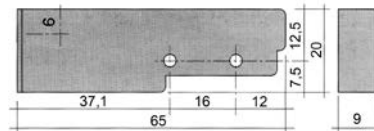

GEV No.	345116	Ref. No.	3003112
description	magnetic switch L 65mm W 20mm 1NO 250V 0.4A P max. 100W connection cable cable length 3000mm		
For models:	OLAX151, OLAX151EDX-1080725, OLAX151LEFT-1080727, OLAX151-highspeed, OLAX160, OLAX160E-1080750, OLAX160E-1080751, OLAX160V-1080755, OLAX160V-1080756, OLAX160V-1081031, OLAX160V-1081032, OLAX210, OLAX210E-1081029, OLAX210E-1081030, OLAX220, OLAX220E-1080787, OLAX220E-1080788, OLAX220V-1080789, OLAX220V-1080790, OLAX230, OLAX230E-1080791, OLAX230E-1080792, OLAX230V-1080793, OLAX230V-1080794, OLAX240, OLAX240E-1080795, OLAX240E-1080796, OLAX240V-1080797, OLAX240V-1080798, OLAX250, OLAX250E-1080760, OLAX250E-1080761, OLAX250V-1080765, OLAX250V-1080766, OLAX300, OLAX300E-1080770, OLAX300E-1080771, OLAX300E-1081033, OLAX300E-1081035, OLAX300E-1081036, OLAX300LC, OLAX300LCE-1081034, OLAX300V-1080775, OLAX300V-1080776, OLAX310, OLAX310E-1081110, OLAX310E-1081111, OLAX310LC, OLAX310LCE-1081114, OLAX310LCE-1081115...(Other models you can see in the webshop)		
accessories for	345116		
	GEV No.	345399	Ref. No. —
	magnet \varnothing 3.3mm L 40mm H 8mm W 13mm hole distance 30mm M3		



miscellaneous



GEV No.	401961	Ref. No.	R66110300
description	magnetic switch door contact		
For models:	CCE071M, CCE101M, CCE102M, CCG071M, CCG101M, CCG102M, CKEP06, CKEP06B, CKEP10, CKEP10B, CKEP20, CKEP20B, CKEP21, CKEP21B, CKEP40, CKEP40B, CKET06, CKET06B, CKET10, CKET10B, CKET20, CKET20B, CKET21, CKET21B, CKET40, CKET40B, CKGP06, CKGP06B, CKGP10, CKGP10B, CKGP20, CKGP20B, CKGP21, CKGP21B, CKGP40, CKGP40B, CKGT06, CKGT06B, CKGT10, CKGT10B, CKGT20B, CKGT21, CKGT21B, CKGT40, CKGT40B		

accessories

magnets

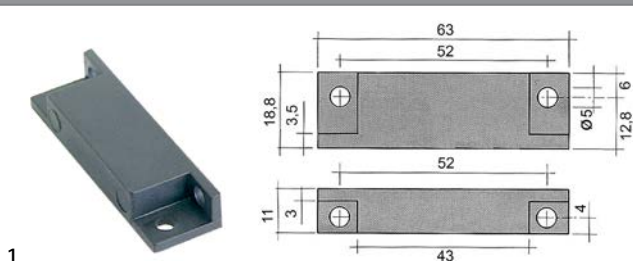

GEV No.	345336	Ref. No.	3108890 80232 BN3108890
description	magnet \varnothing 4.8mm L 63mm H 11mm W 18.8mm hole distance 51mm M4		
For models:	CMV6ES2-1320392, CV10E, CV10E-1320100, CV10E-1320110, CV10E-2, CV10E2-1320140, CV10EB-1321100, CV10E-S, CV10ES-1320150, CV10E-S2, CV10ES2-1320190, CV10G, CV10G-1310100, CV10G-2, CV10G2-1310140, CV10GB-1311100, CV10G-S, CV10GS-1310150, CV10G-S2, CV10GS2-1310190, CV20E, CV20E-1320200, CV20E-2, CV20E2-1320240, CV20EB-1321200, CV20E-S, CV20ES-1320250, CV20E-S2, CV20ES2-1320290, CV20G, CV20G-1310200, CV20G-2, CV20G2-1310240, CV20GB-1311200, CV20G-S, CV20GS-1310250, CV20G-S2, CV20GS2-1310290, CV21E, CV21E-1322100, CV21E-2, CV21E2-1322140, CV21E-S, CV21ES-1322150, CV21E-S2, CV21ES2-1322190, CV21G, CV21G-1312100, CV21G-2, CV21G2-1312140...(Other models you can see in the webshop)		

miscellaneous



GEV No.	346360	Ref. No.	3108879 BN3108879
description	switch mounting pos. door		
For models:	CMV6ES2-1320392, CV10E, CV10E-1320100, CV10E-1320110, CV10E-2, CV10E2-1320140, CV10E-S, CV10ES-1320150, CV10E-S2, CV10ES2-1320190, CV10G, CV10G-1310100, CV10G-2, CV10G2-1310140, CV10G-S, CV10GS-1310150, CV10G-S2, CV10GS2-1310190, CV20E, CV20E-1320200, CV20E-2, CV20E2-1320240, CV20E-S, CV20ES-1320250, CV20E-S2, CV20ES2-1320290, CV20G, CV20G-1310200, CV20G-2, CV20G2-1310240, CV20G-S, CV20GS-1310250, CV20G-S2, CV20GS2-1310290, CV21E, CV21E-1322100, CV21E-2, CV21E2-1322140, CV21E-S, CV21ES-1322150, CV21E-S2, CV21ES2-1322190, CV21G, CV21G-1312100, CV21G-2, CV21G2-1312140, CV21G-S, CV21GS-1312150, CV21G-S2, CV21GS2-1312190...(Other models you can see in the webshop)		

control equipment

MOELLER/EATON

switches (complete)

rotary switches



GEV No.	346461	Ref. No.	R65080150
description	rotary switch mounting measurements \varnothing 22mm black latching 1NC/1NO sequence 0-1		
For models:	CKEP06, CKEP06B, CKEP10, CKEP10B, CKEP20, CKEP20B, CKEP21, CKEP21B, CKEP40, CKEP40B, CKGP06, CKGP06B, CKGP10, CKGP10B, CKGP20, CKGP20B, CKGP21, CKGP21B, CKGP40, CKGP40B		



SIEMENS

3SB series ø16mm

fascias



GEV No.	346357	Ref. No.	3102860 BN3102860
description	blank mounting measurements ø16mm black		
For models:	CMV6ES2-1320392, CV10E, CV10E-1320100, CV10E-1320110, CV10E-2, CV10E2-1320140, CV10EB-1321100, CV10E-S, CV10ES-1320150, CV10E-S2, CV10ES2-1320190, CV10G, CV10G-1310100, CV10G-2, CV10G2-1310140, CV10GB-1311100, CV10G-S, CV10GS-1310150, CV10G-S2, CV10GS2-1310190, CV20E, CV20E-1320200, CV20E-2, CV20E2-1320240, CV20E-S, CV20ES-1320250, CV20E-S2, CV20ES2-1320290, CV20G, CV20G-1310200, CV20G-2, CV20G2-1310240, CV20GB-1311200, CV20G-S, CV20GS-1310250, CV20G-S2, CV20GS2-1310290, CV21E, CV21E-1322100, CV21E-2, CV21E2-1322140, CV21E-S, CV21ES-1322150, CV21E-S2, CV21ES2-1322190, CV21G, CV21G-1312100, CV21G2-1312140, CV21GS-1312150, CV21GS2-1312190, CV6E...(Other models you can see in the webshop)		

push buttons



GEV No.	346356	Ref. No.	3102801 BN3102801
description	push button mounting measurements ø16mm green		
For models:	CV10E, CV10E-1320100, CV10E-2, CV10E2-1320140, CV10EB-1321100, CV10E-S, CV10ES-1320150, CV10E-S2, CV10ES2-1320190, CV10G, CV10G-1310100, CV10G-2, CV10G2-1310140, CV10GB-1311100, CV10G-S, CV10GS-1310150, CV10G-S2, CV10GS2-1310190, CV20E, CV20E-1320200, CV20E-2, CV20E2-1320240, CV20EB-1321200, CV20E-S, CV20ES-1320250, CV20E-S2, CV20ES2-1320290, CV20G, CV20G-1310200, CV20G-2, CV20G2-1310240, CV20GB-1311200, CV20G-S, CV20GS-1310250, CV20G-S2, CV20GS2-1310290, CV21E, CV21E-1322100, CV21E-2, CV21E2-1322140, CV21E-S, CV21ES-1322150, CV21E-S2, CV21ES2-1322190, CV21G, CV21G-1312100, CV21G-2, CV21G2-1312140, CV21G-S, CV21GS-1312150...(Other models you can see in the webshop)		

3SB series ø22mm old



GEV No.	346354	Ref. No.	3102803 BN3102803
description	contact block SIEMENS 1NO 3SB2404-0B brown max 250V 10A		
For models:	CMV6ES2-1320392, CV10E, CV10E-1320100, CV10E-1320110, CV10E-2, CV10E2-1320140, CV10EB-1321100, CV10E-S, CV10ES-1320150, CV10E-S2, CV10ES2-1320190, CV10G, CV10G-1310100, CV10G-2, CV10G2-1310140, CV10GB-1311100, CV10G-S, CV10GS-1310150, CV10G-S2, CV10GS2-1310190, CV20E, CV20E-1320200, CV20E-2, CV20E2-1320240, CV20EB-1321200, CV20E-S, CV20ES-1320250, CV20E-S2, CV20ES2-1320290, CV20G, CV20G-1310200, CV20G-2, CV20G2-1310240, CV20GB-1311200, CV20G-S, CV20GS-1310250, CV20G-S2, CV20GS2-1310290, CV21E, CV21E-1322100, CV21E-2, CV21E2-1322140, CV21E-S, CV21ES-1322150, CV21E-S2, CV21ES2-1322190, CV21G, CV21G-1312100, CV21G-2, CV21G2-1312140...(Other models you can see in the webshop)		

encoders and potentiometers





GEV No.	401194	Ref. No.	3103267 BN3103267
description	encoder		
For models:	ECVM10ES2, ECVM10ES2-1324290, ECVM10ES2-1324290MN, ECVM10ES2-1326120, ECVM10GS2, ECVM10GS2-1314290, ECVM10GS2-1316120, ECVM20ES2, ECVM20ES2-1324390, ECVM20ES2-1326140, ECVM20GS2, ECVM20GS2-1314390, ECVM20GS2-1316140, ECVM21ES2, ECVM21ES2-1324490, ECVM21ES2-1326160, ECVM21GS2-1314490, ECVM21GS2-1316160, ECVM6ES2, ECVM6ES2-1324190, ECVM6ES2-1326100, ECVM6ES2-1326100H, ECVM6GS2, ECVM6GS2-1314190, ECVM6GS2-1316100, ECVP10ES2, ECVP10ES2-1324690, ECVP10ES2-1326200, ECVP10GS2, ECVP10GS2-1314690, ECVP10GS2-1316200, ECVP20ES2, ECVP20ES2-1324790, ECVP20ES2-1326220, ECVP20GS2, ECVP20GS2-1314790, ECVP20GS2-1316220, ECVP21ES2, ECVP21ES2-1324890, ECVP21ES2-1326240, ECVP21GS2, ECVP21GS2-1314890, ECVP21GS2-1316240, ECVP6ES2, ECVP6ES2-1324590, ECVP6ES2-1326180, ECVP6GS2, ECVP6GS2-1314590, ECVP6GS2-1316180, NECVM10ES2...(Other models you can see in the webshop)		



GEV No.	401338	Ref. No.	R65301450
description	encoder		
For models:	CKEP06, CKEP06B, CKEP10, CKEP10B, CKEP20, CKEP20B, CKEP21, CKEP21B, CKEP40, CKEP40B, CKET06, CKET06B, CKET10, CKET10B, CKET20, CKET20B, CKET21, CKET21B, CKET40, CKET40B, CKGP06, CKGP06B, CKGP10, CKGP10B, CKGP20, CKGP20B, CKGP21, CKGP21B, CKGP40, CKGP40B, CKGT06, CKGT06B, CKGT10, CKGT10B, CKGT20, CKGT20B, CKGT21, CKGT21B, CKGT40, CKGT40B		

			
GEV No.	403835	Ref. No.	LA65302500
description	encoder rotation 360° shaft ø 6x4.6mm shaft L 26mm for combi-steamer cable length 600mm SS		

			
GEV No.	403084	Ref. No.	LA65301941 LAR65301940
description	encoder shaft L 18mm cable length 200mm shaft 6x4.6mm		

			
GEV No.	300188	Ref. No.	3103260 BN3103260
description	potentiometer rotation 310° oven		
For models:	CMV6ES2-1320392, CV10E, CV10E-1320100, CV10E-1320110, CV10E-2, CV10E2-1320140, CV10EB-1321100, CV10E-S, CV10ES-1320150, CV10E-S2, CV10ES2-1320190, CV10G, CV10G-1310100, CV10G-2, CV10G2-1310140, CV10GB-1311100, CV10G-S, CV10GS-1310150, CV10G-S2, CV10GS2-1310190, CV20E, CV20E-1320200, CV20E-2, CV20E2-1320240, CV20EB-1321200, CV20E-S, CV20ES-1320250, CV20E-S2, CV20ES2-1320290, CV20G, CV20G-1310200, CV20G-2, CV20G2-1310240, CV20GB-1311200, CV20G-S, CV20GS-1310250, CV20G-S2, CV20GS2-1310290, CV21E-1322100, CV21E2-1322140, CV21ES-1322150, CV21ES2-1322190, CV21G, CV21G-1312100, CV21G-2, CV21G2-1312140, CV21G-S, CV21GS-1312150, CV21G-S2, CV21GS2-1312190...(Other models you can see in the webshop)		



lamps

indicator lights

indicator lights 2-piece (lens and indicator lamp)

indicator light lenses

ø10mm (type SRZ-3)

			
GEV No.	359123	Ref. No.	6A038501
description	indicator light housings mounting measurements ø10mm green round Qty 1 pcs		
accessories for	359123		
	GEV No.	359132	Ref. No.
			15826
	indicator lamp green 250V connection male faston 6.3mm protection IP54 ambient temperature max. 85°C		

ø12mm (type SDY-3)

			
GEV No.	359262	Ref. No.	6A001438 BN6A001438
description	indicator light housings mounting measurements ø12mm green round Qty 1 pcs		
For models:	94-04PEI100L, 94-04PEI100L-12901765, 94-04PEI110L-12901765BN, 94-04PEI150L, 94-04PEI150L-12901767, 94-04PEI150L-12901767BN, 9PN-EI100, 9PN-EI150		

			
GEV No.	359261	Ref. No.	6A001436 BN6A001436
description	indicator light housings mounting measurements ø12mm red round Qty 1 pcs		
For models:	94-04PEI100L, 94-04PEI100L-12901765, 94-04PEI110L-12901765BN, 94-04PEI150L, 94-04PEI150L-12901767, 94-04PEI150L-12901767BN, 9PN-EI100, 9PN-EI150		

indicator lamps for socket type SRZ / SDK / SDY / SFK

			
GEV No.	359132	Ref. No.	15826
description	indicator lamp green 250V connection male faston 6.3mm protection IP54 ambient temperature max. 85°C		
For models:	OLDerby, OLDS35, OLDS35-1081005, OLDS35-1081061, OLDS35D-1081062, OLDS35-Neutra, OLDS37, OLDS37-1081006, OLDS37-1081063, OLDS37D-1081007, OLDS37D-1081064, OLDS37LS-1081008, OLDS37LSD-1081009, OLDS37-Neutra, OLDS40, OLDS40-1081010, OLDS40-1081065, OLDS40D-1081011, OLDS40D-1081066, OLDS40E-1081067, OLDS40ED-1081068, OLDS40LS-1081012, OLDS40LSD-1081013, OLDS40-Neutra, OLDS45, OLDS50, OLDS50-1081088, OLDS50D-1081089, OLDS50E-1081090, OLDS50ED-1081091, OLDS50-Neutra, OLDS50P-1081018, OLDS50PD-1081019, OLG35, OLG35-1080702, OLG35D-1081000, OLG35-Neutra, OLG600, OLGastro450, OLGastro500Plus, OLGastro500S, OLGastro750Plus, OLGastro750S, OLG37, OLG37-1080700, OLG37D-1080707, OLG37LS-1081001, OLG37LSD-1081002, OLG37-Neutra, OLG37LS-1081001, OLG37LSD-1081002, OLG37-Neutra, OLG37LS-1081001, OLG37LSD-1081002, OLG37-Neutra, OLG37LS-1081001, OLG37LSD-1081002, OLG37-Neutra, OLG37LS-1081001, OLG37LSD-1081002...(Other models you can see in the webshop)		

indicator lights (complete)

ø 6mm

			
GEV No.	359284	Ref. No.	2959600 MA2959600
description	indicator light ø 6mm 24V green cable length 150mm		

			
1			
GEV No.	359285	Ref. No.	2959700 MA2959700
description	indicator light ø 6mm 24V yellow cable length 150mm		

ø10mm			
with screw socket			
			
1			
GEV No.	359378	Ref. No.	1037300810
description	indicator light ø 10mm 230V green connection male faston 6.3mm socket screw base		
For models:	BRE40, BRE40D, BRE40DB, BRE40DG, BRE40DGB, BRE40G, BSEI40M, CFE60, CFE60P, FQE41, FQE41L, FQE41L2, FQE61, FQE61L, FQE61L2, FTE100B, FTE100BR, FTE100CRL, FTE40B, FTE40BR, FTE40C, FTE40D, FTE40DC, FTE60B, FTE60BR, FTE60C, FTE60D, FTE60DC, FTE60DR, FTE60DRCL, OBRE40, OBRE-40-12601110, OBRE-40-12601110MN, OBSEI40M, OBSEI-40M-12601700, OCFE60, OCFE-60-12601005, OCFE-60-12601005MN, OCFGE61, OFQE41, OFQE41-12601510, OFQE41-12601510MN, OFQE41L, OFQE61, OFQE61-12601610, OFQE61-12601610MN, OFQE61L, OFTE-100C-12601136, OFTE-100C-12601136MN, OFTE100CRL...(Other models you can see in the webshop)		

with plug-in socket			
			
1			
GEV No.	359139	Ref. No.	10711/B
description	indicator light ø 10mm green 230V connection male faston 6.3mm Qty 1 pcs		
For models:	OLDS35-Neutra, OLDS37-Neutra, OLDS40-Neutra, OLDS50-Neutra, OLG35-Neutra, OLG37-Neutra, OLG340, OLG340-Neutra, OLG350ECOD-1081015, OLG350-Neutra, OLH600, OLHT-11-Neutra, OLHT11S-Neutra, OLHT12-1081075, OLHT12EL-1081080, OLHT12EL-1081083, OLHT12ELD-1081081, OLHT12ELPLUS-1081086, OLHT12S, OLHT12S-Neutra, OLLP1-800-Neutra		

			
1			
GEV No.	359140	Ref. No.	1037300900 1037300910
description	indicator light ø 10mm yellow 230V connection male faston 6.3mm Qty 1 pcs		
For models:	BRE40, BRE40D, BRE40DB, BRE40DG, BRE40DGB, BRE40G, BSEI40M, CFE60, CFE60P, FQE41, FQE41L, FQE41L2, FQE61, FQE61L, FQE61L2, FTE100B, FTE100BR, FTE100CRL, FTE40B, FTE40BR, FTE40C, FTE40D, FTE40DC, FTE60B, FTE60BR, FTE60C, FTE60D, FTE60DC, FTE60DR, FTE60DRCL, OBME41M, OBME61M, OBRE40, OBRE-40-12601110, OBRE-40-12601110MN, OBSEI40M, OBSEI-40M-12601700, OCFE60, OCFE-60-12601005, OCFE-60-12601005MN, OCFGE61, OFQE41, OFQE41-12601510, OFQE41-12601510MN, OFQE41L, OFQE61, OFQE61-12601610, OFQE61-12601610MN, OFQE61L, OFTE-100C-12601136...(Other models you can see in the webshop)		

ø12mm			
with screw socket			
			
1			
GEV No.	359291	Ref. No.	6A038507 von 2010 A038507VON2010 BN6A038507 von 2010 SI0101169 SIR0101169
description	indicator light ø 12mm 400V green connection male faston 6.3mm		

ø16mm			
with plug-in socket			
			
1			
GEV No.	359788	Ref. No.	R65270160
description	indicator light ø 16mm 230V green connection male faston 6.3mm		
For models:	CCE042M, CCE071M, CCE101M, CCE102M, CCG071M, CCG101M, CCG102M		

			
1			
GEV No.	359789	Ref. No.	R65270150
description	indicator light ø 16mm 230V yellow connection male faston 6.3mm		
For models:	CCE042M, CCE071M, CCE101M, CCE102M, CCG071M, CCG101M, CCG102M		

ø18mm			
			
1			
GEV No.	346358	Ref. No.	3102850 BN3102850
description	lamp socket ø 18mm 230V without cap		
For models:	CV10E, CV10E-1320100, CV10E-2, CV10E2-1320140, CV10EB-1321100, CV10E-S, CV10ES-1320150, CV10E-S2, CV10ES2-1320190, CV10G, CV10G-1310100, CV10G-2, CV10G2-1310140, CV10GB-1311100, CV10G-S, CV10GS-1310150, CV10G-S2, CV10GS2-1310190, CV20E, CV20E-1320200, CV20E-2, CV20E2-1320240, CV20EB-1321200, CV20E-S, CV20ES-1320250, CV20E-S2, CV20ES2-1320290, CV20G, CV20G-1310200, CV20G-2, CV20G2-1310240, CV20GB-1311200, CV20G-S, CV20GS-1310250, CV20G-S2, CV20GS2-1310290, CV21E, CV21E-1322100, CV21E-2, CV21E2-1322140, CV21E-S, CV21ES-1322150, CV21E-S2, CV21ES2-1322190, CV21G, CV21G-1312100, CV21G-2, CV21G2-1312140, CV21G-S, CV21GS-1312150...(Other models you can see in the webshop)		



screw-on/push-on fit

halogen lamp

for socket G4 / G6.35 / G9



GEV No.	359599	Ref. No.	LA65270020 LAR65270020
description	halogen lamp socket G4 12V 20W temp.-resist. 500°C		
For models:	CCE071M, CCE101M, CCE102M, CCG071M, CCG101M, CCG102M, CKEP06, CKEP06B, CKEP10, CKEP10B, CKEP20, CKEP20B, CKEP21, CKEP21B, CKEP40, CKEP40B, CKET06, CKET06B, CKET10, CKET10B, CKET20, CKET20B, CKET21, CKET21B, CKET40, CKET40B, CKGP06, CKGP06B, CKGP10, CKGP10B, CKGP20, CKGP20B, CKGP21B, CKGP40, CKGP40B, CKGT06, CKGT06B, CKGT10, CKGT10B, CKGT20B, CKGT21, CKGT21B, CKGT40, CKGT40B		

fluorescent lamps

accessories

ballasts



GEV No.	401187	Ref. No.	6A047060 BN6A047060
description	electrical ballast 60W for fluorescent lamps		
For models:	CV10E, CV10E-1320100, CV10E-2, CV10E2-1320140, CV10E-S, CV10ES-1320150, CV10E-S2, CV10ES2-1320190, CV10G, CV10G-1310100, CV10G-2, CV10G2-1310140, CV10G-S, CV10GS-1310150, CV10G-S2, CV10GS2-1310190, CV20E, CV20E-1320200, CV20E-2, CV20E2-1320240, CV20E-S, CV20ES-1320250, CV20E-S2, CV20ES2-1320290, CV20G, CV20G-1310200, CV20G-2, CV20G2-1310240, CV20G-S, CV20GS-1310250, CV20G-S2, CV20GS2-1310290, CV6E, CV6E-1320000, CV6E-1320050, CV6E-2, CV6E2-1320040, CV6E-S, CV6E-S2, CV6ES2-1320090, CV6G, CV6G-1310000, CV6G-2, CV6G2-1310040, CV6G-S, CV6GS-1310050, CV6G-S2, CV6GS2-1310090, CVM10E, CVM10E-1320400...(Other models you can see in the webshop)		

oven lamps

universal oven lamps

mounting diameter 35.5mm



GEV No.	359718	Ref. No.	1037300100
description	oven lamp mounting ø 35.5mm 230V 15W socket E14 temp.-resist. 300°C connection male faston 6.3mm hard glas		
For models:	FOE60M, OFOE60M, OFOE-60M-12601001		
spare parts for	359718		
	GEV No.	359701	Ref. No. —
	lamp socket socket E14 220-230V mounting ø 35.5mm connection male faston 6.3mm 15W		

spare parts for	359718		
	GEV No.	359740	Ref. No. —
	light bulb t.max. 300°C socket E14 15W 230V ø 22mm L 48mm lens L 20mm for oven lamp IMPORT		

55x70mm



GEV No.	359375	Ref. No.	R65270510
description	lamp socket complete version socket E14 mounting measurements 55x70mm		
For models:	CCE042M, CCE051M, CCG051M		

lamps

halogen lamps

for socket G4 / G6.35 / G9



GEV No.	359599	Ref. No.	LA65270020 LAR65270020
description	halogen lamp socket G4 12V 20W temp.-resist. 500°C		
For models:	CCE071M, CCE101M, CCE102M, CCG071M, CCG101M, CCG102M, CKEP06, CKEP06B, CKEP10, CKEP10B, CKEP20, CKEP20B, CKEP21, CKEP21B, CKEP40, CKEP40B, CKET06, CKET06B, CKET10, CKET10B, CKET20, CKET20B, CKET21, CKET21B, CKET40, CKET40B, CKGP06, CKGP06B, CKGP10, CKGP10B, CKGP20, CKGP20B, CKGP21B, CKGP40, CKGP40B, CKGT06, CKGT06B, CKGT10, CKGT10B, CKGT20B, CKGT21, CKGT21B, CKGT40, CKGT40B		

sockets

G4 / G5,3 / G6,35



GEV No.	359836	Ref. No.	3108860 BN3108860
description	lamp socket socket G4 for halogen lamp		
For models:	CMV6E52-1320392, CV10E, CV10E-1320100, CV10E-1320110, CV10E-2, CV10E2-1320140, CV10E-S, CV10ES-1320150, CV10E-S2, CV10ES2-1320190, CV10G, CV10G-1310100, CV10G-2, CV10G2-1310140, CV10G-S, CV10GS-1310150, CV10G-S2, CV10GS2-1310190, CV20E, CV20E-1320200, CV20E-2, CV20E2-1320240, CV20E-S, CV20ES-1320250, CV20E-S2, CV20ES2-1320290, CV20G, CV20G-1310200, CV20G-2, CV20G2-1310240, CV20G-S, CV20GS-1310250, CV20G-S2, CV20GS2-1310290, CV21E, CV21E-1322100, CV21E-2, CV21E2-1322140, CV21E-S, CV21ES-1322150, CV21E-S2, CV21ES2-1322190, CV21G, CV21G-1312100, CV21G-2, CV21G2-1312140, CV21G-S, CV21GS-1312150, CV21G-S2, CV21GS2-1312190...(Other models you can see in the webshop)		

timers

programme timers

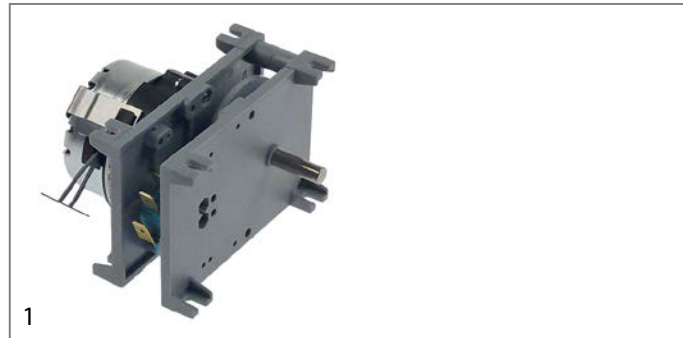

GEV No.	403577	Ref. No.	LAR65090220 LAR65095000
description	gear motor CDC 4901F1 engines 1 chambers 1 operation time 20s 230V 50Hz shaft ø 6x4.6mm shaft L 24mm		
For models:	CCG071M, CCG101M, CCG102M, CKEP06, CKEP06B, CKEP10, CKEP10B, CKEP20, CKEP20B, CKEP21, CKEP21B, CKEP40, CKEP40B, CKET06, CKET06B, CKET10, CKET10B, CKET20, CKET20B, CKET21, CKET21B, CKET40, CKET40B, CKGP06, CKGP06B, CKGP10, CKGP10B, CKGP20, CKGP20B, CKGP21, CKGP21B, CKGP40, CKGP40B, CKGT06, CKGT06B, CKGT10B, CKGT20, CKGT20B, CKGT21, CKGT21B, CKGT40, CKGT40B		

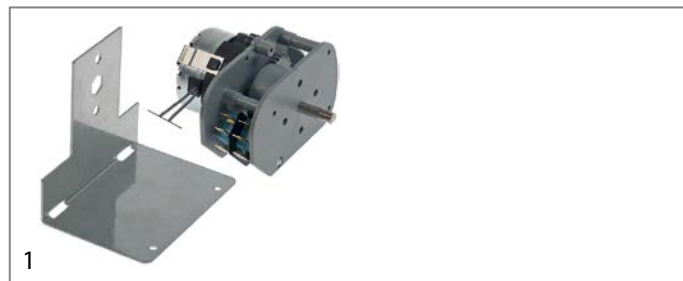

GEV No.	360633	Ref. No.	6A047080 BN6A047080
description	time switch kit 14000F3 operation time 120min impulse electric shaft ø 6x4.6mm shaft L 20mm CDC 230V engines 1 chambers 2		
For models:	CV10E, CV10E-1320100, CV10E-2, CV10E2-1320140, CV10EB-1321100, CV10E-S, CV10ES-1320150, CV10E-S2, CV10ES2-1320190, CV10G, CV10G-1310100, CV10G-2, CV10G2-1310140, CV10GB-1311100, CV10G-S, CV10GS-1310150, CV10G-S2, CV10GS2-1310190, CV20E, CV20E-1320200, CV20E-2, CV20E2-1320240, CV20EB-1321200, CV20E-S, CV20ES-1320250, CV20E-S2, CV20ES2-1320290, CV20G, CV20G-1310200, CV20G-2, CV20G2-1310240, CV20GB-1311200, CV20G-S, CV20GS-1310250, CV20G-S2, CV20GS2-1310290, CV21E, CV21E-1322100, CV21E-2, CV21E2-1322140, CV21E-S, CV21ES-1322150, CV21E-S2, CV21ES2-1322190, CV21G, CV21G-1312100, CV21G-2, CV21G2-1312140, CV21G-S, CV21GS-1312150...(Other models you can see in the webshop)		



GEV No.	360709	Ref. No.	LA65090110 LAR65090110
description	timer CDC 14003F3 engines 1 chambers 3 operation time 120min shaft ø 6x4.6mm shaft L 22mm manif. no. 14003F3120ME0.0010		

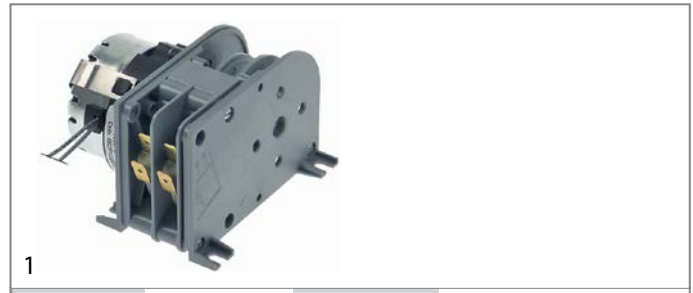

GEV No.	360752	Ref. No.	R65090190
description	timer CDC 4902F1 engines 1 chambers 2 operation time 8min 230V shaft ømm shaft Lmm		
For models:	CCE042M, CCE051M, CCE071M, CCE101M, CCE102M, CCG051M, CCG071M, CCG101M, CCG102M		

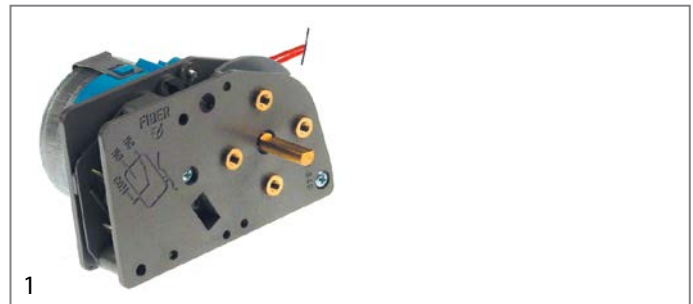

GEV No.	360336	Ref. No.	3102335 BN3102335
description	timer FIBER P25 engines 1 chambers 1 operation time 30s 230V shaft ø 6x4.6mm shaft L 18mm manif. no. P255J01C6R7 motor type M51BJ0R6400		
For models:	ECVM10ES2, ECVM10ES2-1324290, ECVM10ES2-1324290MN, ECVM10ES2-1326120, ECVM10GS2, ECVM10GS2-1314290, ECVM10GS2-1316120, ECVM20ES2, ECVM20ES2-1324390, ECVM20ES2-1326140, ECVM20GS2, ECVM20GS2-1314390, ECVM20GS2-1316140, ECVM21ES2, ECVM21ES2-1324490, ECVM21ES2-1326160, ECVM21GS2, ECVM21GS2-1314490, ECVM21GS2-1316160, ECVM6ES2, ECVM6ES2-1324190, ECVM6ES2-1326100, ECVM6ES2-1326100H, ECVM6GS2, ECVM6GS2-1314190, ECVM6GS2-1316100, ECVP10ES2, ECVP10ES2-1324690, ECVP10ES2-1326200, ECVP10GS2, ECVP10GS2-1314690, ECVP10GS2-1316200, ECVP20ES2, ECVP20ES2-1324790, ECVP20ES2-1326220, ECVP20GS2, ECVP20GS2-1314790, ECVP20GS2-1316220, ECVP21ES2, ECVP21ES2-1324890, ECVP21ES2-1326240, ECVP21GS2, ECVP21GS2-1314890, ECVP21GS2-1316240, ECVP6ES2, ECVP6ES2-1324590, ECVP6ES2-1326180, ECVP6GS2, ECVP6GS2-1314590, ECVP6GS2-1316180...(Other models you can see in the webshop)		

spare parts for	360336	GEV No.	360673	Ref. No.	—
					motor kit pinion ø 6.8mm teeth 15 230V voltage AC 50/60Hz turn direction clockwise motor ø 48mm H 18.5mm motor type UDS-40NE1RNZ165 cable length 150mm with holder

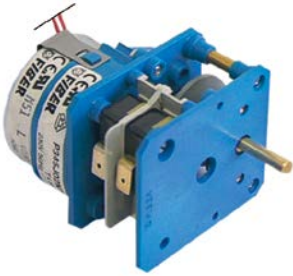

1

GEV No.	350038	Ref. No.	R65090020
description	timer FIBER P34 engines 1 chambers 2 operation time 144min 230V shaft ø 6x4.6mm shaft L 20mm manuf. no. P345J02N765 motor type M51BJ0L6400 impulse electric		
For models:	CCE042M, CCE051M, CCE071M, CCE101M, CCE102M, CCG051M, CCG071M, CCG101M, CCG102M		

audible timers



1

GEV No.	350036	Ref. No.	1031006400
description	audible timer operation time 60min ø 55mm shaft ø 6x4.6mm shaft L 22mm mounting distance 28mm		
For models:	FOE60M, OFOE60M, OFOE-60M-12601001		

alarm devices

buzzers

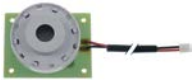

1

GEV No.	350086	Ref. No.	R65301440
description	buzzer 12VDC connection cable 200mm PCB buzzer 20dB		
For models:	CKEP06, CKEP06B, CKEP10, CKEP10B, CKEP20, CKEP20B, CKEP21, CKEP21B, CKEP40, CKEP40B, CKET06, CKET06B, CKET10, CKET10B, CKET20, CKET20B, CKET21, CKET21B, CKET40, CKET40B, CKGP06, CKGP06B, CKGP10, CKGP10B, CKGP20, CKGP20B, CKGP21, CKGP21B, CKGP40, CKGP40B, CKGT06, CKGT06B, CKGT10, CKGT10B, CKGT20, CKGT20B, CKGT21, CKGT21B, CKGT40, CKGT40B		



1

GEV No.	350223	Ref. No.	LA65302450
description	buzzer 12VDC connection coded PCB buzzer 20dB		



1

GEV No.	350050	Ref. No.	R65330010
description	buzzer 230VAC connection male faston 6.3mm screw mounting thread M4 60dB		
For models:	CCE042M, CCE051M, CCE071M, CCE101M, CCE102M, CCG051M, CCG071M, CCG101M, CCG102M		



1

GEV No.	350080	Ref. No.	3103266 BN3103266
description	buzzer buzzer		
For models:	ECVM10ES2, ECVM10ES2-1324290, ECVM10ES2-1324290MN, ECVM10ES2-1326120, ECVM10GS2, ECVM10GS2-1314290, ECVM10GS2-1316120, ECVM20ES2, ECVM20ES2-1324390, ECVM20ES2-1326140, ECVM20GS2, ECVM20GS2-1314390, ECVM20GS2-1316140, ECVM21ES2, ECVM21ES2-1324490, ECVM21ES2-1326160, ECVM21GS2-1314490, ECVM21GS2-1316160, ECVM6ES2, ECVM6ES2-1324190, ECVM6ES2-1326100, ECVM6ES2-1326100H, ECVM6GS2, ECVM6GS2-1314190, ECVM6GS2-1316100, ECVP10ES2, ECVP10ES2-1324690, ECVP10ES2-1326200, ECVP10GS2, ECVP10GS2-1314690, ECVP10GS2-1316200, ECVP20ES2, ECVP20ES2-1324790, ECVP20ES2-1326220, ECVP20GS2, ECVP20GS2-1314790, ECVP20GS2-1316220, ECVP21ES2, ECVP21ES2-1324890, ECVP21ES2-1326240, ECVP21GS2, ECVP21GS2-1314890, ECVP21GS2-1316240, ECVP6ES2, ECVP6ES2-1324590, ECVP6ES2-1326180, ECVP6GS2, ECVP6GS2-1314590, ECVP6GS2-1316180, NECVM10ES2...(Other models you can see in the webshop)		

contactors

ABB

power contactors



1

GEV No.	380104	Ref. No.	6A001410
description	power contactor resistive load 25A 230VAC (AC3/400V) 9A/4kW main contacts 3NO auxiliary contacts 1NO connection screw connection type A9-30-10		
For models:	94-04PEI100L, 94-04PEI100L-12901765, 94-04PEI110L-12901765BN, 94-04PEI150L, 94-04PEI150L-12901767, 94-04PEI150L-12901767BN, 9PN-EI100, 9PN-EI150		

GENERAL ELECTRIC (AEG)

power contactors



1

GEV No.	380239	Ref. No.	10300391 15086/B 6A047031 A0447037 BN6A047031
description	power contactor resistive load 20A 230VAC (AC3/400V) 8.4A/4kW main contacts 3NO auxiliary contacts 1NC connection screw connection type LS05 01A type AEG LS05 01A type GE MC1A 301A		
For models:	110-135CGE, 110-135CGE2P, 110-135CGEE, 110-135CGEE2P, 110-135CGEEP, 110-135CGEP, 110-90CGE, 110-90CGE1P, 110-90CGEP, 110-90CTEE, 110-90CTGE, 110-90FTE, 110-90FTE1-2R, 110-90FTEC, 110-90FTEC1-2R, 110-90FTECR, 110-90FTEE, 110-90FTE1-2R, 110-90FTTGE, 110-90FTTE, 110-90FTTE1-2R, 110-90FTTEC, 110-90FTTEC1-2R, 110-90FTTECR, 110-90FTTER, 55-45FRE, 55-90FRE, 73-02FRE, 73-02FRE-12701550, 73-02FREM, 73-02FREM-12701580, 7FRI-E610, 93-04FRE10L, 93-04FRE-12901550, 94-04CEE, 94-04CEE-12901210, 94-04CEE-12901210BN, 94-04CGE-12900011, 94-04CGE-12900011TA, 94-04CGE1P-12900031, 94-04CGEP-12900061, 94-04CGEP-12900061TA, 94-04CGG1P-12900031TA, 94-04CTEE-12901180, 94-04CTEE-12901180BN, 94-04CTEES, 94-04CTEES-12901185, 94-04CTEES-12901185BN, 94-04CTGE, 94-04CTGE-12900190...(Other models you can see in the webshop)		



1

GEV No.	380238	Ref. No.	10300392
description	power contactor resistive load 20A 230VAC (AC3/400V) 8.4A/4kW main contacts 3NO auxiliary contacts 1NO connection screw connection type LS0510A type AEG LS0510A type GE MC1A 310A		
For models:	OLH600, OLH600Electronic, OLHT11-1081071, OLHT11D-1081072, OLHT11ECO-1081070, OLHT11-Neutra, OLHT11S, OLHT11S-Neutra, OLHT12-1081075, OLHT12EL-1081080, OLHT12EL-1081083, OLHT12ELD-1081081, OLHT12ELPLUS-1081086, OLHT12S, OLHT12SElectronic, OLHT12S-Neutra		



1

GEV No.	380337	Ref. No.	6A047037 BN6A047037
description	power contactor resistive load 20A 230VAC (AC3/400V) 8.4A/4kW main contacts 4NO auxiliary contacts connection screw connection type AEG LS05 400A type GE MC1A 400A		
For models:	421SEFR-1826125, 621SEFR-1826135, CV10E, CV10E-1320100, CV10E-2, CV10E2-1320140, CV10EB-1321100, CV10E-S, CV10ES-1320150, CV10E-S2, CV10ES2-1320190, CV10G, CV10G-1310100, CV10G-2, CV10G2-1310140, CV10GB-1311100, CV10G-S, CV10GS-1310150, CV10G-S2, CV10GS2-1310190, CV20E, CV20E-1320200, CV20E-2, CV20E2-1320240, CV20EB-1321200, CV20E-S, CV20ES-1320250, CV20E-S2, CV20ES2-1320290, CV20G, CV20G-1310200, CV20G-2, CV20G2-1310240, CV20GB-1311200, CV20G-S, CV20GS-1310250, CV20G-S2, CV20GS2-1310290, CV21E, CV21E-1322100, CV21E-2, CV21E2-1322140, CV21E-S, CV21ES-1322150, CV21E-S2, CV21ES2-1322190, CV21G, CV21G-1312100, CV21G-2, CV21G2-1312140...(Other models you can see in the webshop)		



1

GEV No.	380245	Ref. No.	6A047034 BN6A047034
description	power contactor resistive load 25A 230VAC (AC3/400V) 9A/4kW main contacts 3NO auxiliary contacts 1NC connection screw connection type AEG LS4K 01A type GE CL00A 301 H 85mm		
For models:	40SEW-1825190, 41SEFR, 41SEFR-1826120, 41SEFR2S-1826120, 61SEFR, 61SEFR-1826130, 61SEFR2S-1826130, 7101FR-E-1077750R, 7121FR-E-1077950R, 7201FR-E-1077850R, 72-02FRE, 72-02FRE-12701500, 72-02FREM, 72-02FREM-12701530, 7221FR-E-1078050R, 725KB-E-1000200, 725KB-E-1000200R, 725KB-EB-1000201, 725KB-EB-1000201R, 725KB-EM-1000210R, 725KB-EMB-1000211, 73-02FRE, 73-02FRE-12701550, 74-02FRE, 74-02FRE-12701600, 74-02FREM, 74-02FREM-12701630, 74-02KBEB, 74-02KBEB-12701110, 74-02KBEBI, 74-02KBEBI-12701115, 74-02KBEBI, 74-02KBEBI-12701128, 74-02KBEMB, 74-02KBEMB-12701120, 74-02KBEMB, 74-02KBEMB-12701125, 74-02KBEMB-12701125HB, 74-02NPEI, 74-02NPEI-12701755, 7FRI-E415, 7FRI-E415M, 7FRI-E815, 7PN-EI50, 9122PFRE-1104930, 9141PFRE-1204950, 92-04FRE15L, 92-04FRE15L-12901510, 921FRE-1292925, 921RFRE-1392925...(Other models you can see in the webshop)		



1

GEV No.	380244	Ref. No.	10300050
description	power contactor resistive load 25A 230VAC (AC3/400V) 9A/4kW main contacts 3NO auxiliary contacts 1NO connection screw connection type AEG LS4K 10A type GE CL00A 310		
For models:	G12S, OLGRANUL900, OLH600, OLH600Electronic, OLHT11-1081071, OLHT11D-1081072, OLHT11ECO-1081070, OLHT-11-Neutra, OLHT11S, OLHT11S-Neutra, OLHT12-1081075, OLHT12EL-1081080, OLHT12EL-1081083, OLHT12ELD-1081081, OLHT12ELPLUS-1081086, OLHT12S, OLHT12SElectronic, OLHT12S-Neutra, OLLP1-1081059, OLLP1-800, OLLP1-800-1080721, OLLP1-800EL, OLLP1-800-Neutra, OLLP1-S8, OLLP1-S8EL, OLLP2-1080722, OLLP2-1080742, OLLP-2Electronic-Neutra, OLLP-2PLUS, OLLP3-1080723, OLLP3-1080743, OLLP3Electronic-Neutra, OLLP-3PLUS, OLLP4-1081258, OLLP4-800-1081058, OLLP4-800Electronic-Neutra, OLLP-4PLUS, OLLP-ZERO, OLLPZERO-1081057		



1

GEV No.	380262	Ref. No.	10300052 6A047036 BN6A047036
description	power contactor resistive load 32A 230VAC (AC3/400V) 17A/7.5kW main contacts 3NO auxiliary contacts 1NC connection screw connection type AEG LS7K01A type GE CL02A 301 H 85mm		
For models:	72-02TVTCV, 72-02TVTCV-12731005, 72-02VTC, 72-02VTCV, 72-02VTG-12701005, 74-02TVTCV, 74-02TVTCV-12731006, 74-02VTCEV, 74-02VTCEV-12701020, 74-02VTCV, 74-02VTCV-12701006, 7NPCF-VCE800, 92-04FRE20L, 92-04FRE20L-12901500, 92-04FRE20L-12901500BN, 92-04VTC, 92-04VTC-12931005, 92-04VTCV-12931055, 92-04VTC, 92-04VTCV-12901055, 94-04FRE-12901600, 94-04FRE20L, 9FRI-E415, 9FRI-E420, 9FRI-E610, 9FRI-E820, 9NPC-VCE400, 9NPCV-VCE400, CV20E, CV20E-1320200, CV20E-2, CV20E2-1320240, CV20EB-1321200, CV20E-S, CV20ES-1320250, CV20E-S2, CV20ES2-1320290, CVM20E, CVM20E-1320500, CVM20E-2, CVM20E2-1320540, CVM20E-S, CVM20ES-1320550, CVM20E-S2, CVM20ES2-1320590, CVP20E, CVP20E-1320800, CVP20E-2, CVP20E2-1320840, CVP20EB-1321200...(Other models you can see in the webshop)		

auxiliary contacts



1

GEV No.	380242	Ref. No.	6A047038 BN6A047038
description	auxiliary contact contacts 1NO/1NC for contactors M+LS05 connection screw AC-12 10A type AEG HS05K 11HS type GE MARN 211		
For models:	CV10E, CV10E-1320100, CV10E-2, CV10E2-1320140, CV10EB-1321100, CV10E-S, CV10ES-1320150, CV10E-S2, CV10ES2-1320190, CV10G, CV10G-1310100, CV10G-2, CV10G2-1310140, CV10GB-1311100, CV10G-S, CV10GS-1310150, CV10G-S2, CV10GS2-1310190, CV20E, CV20E-1320200, CV20E-2, CV20E2-1320240, CV20EB-1321200, CV20E-S, CV20ES-1320250, CV20E-S2, CV20ES2-1320290, CV20G, CV20G-1310200, CV20G-2, CV20G2-1310240, CV20GB-1311200, CV20G-S, CV20GS-1310250, CV20G-S2, CV20GS2-1310290, CV21E-1322100, CV21E-2, CV21E2-1322140, CV21E-S2, CV21ES2-1322190, CV21G-2, CV21G2-1312140, CV21G-S2, CV21GS2-1312190, CV6E, CV6E-1320000, CV6E-1320050, CV6E-2, CV6E2-1320040...(Other models you can see in the webshop)		



1

GEV No.	380243	Ref. No.	6A047039 BN6A047039
description	auxiliary contact contacts 2NO/2NC for contactors M+LS05 connection screw AC-12 10A type AEG HS05K 22HS type GE MARN 422		
For models:	CV10E-2, CV10E2-1320140, CV10E-S2, CV10ES2-1320190, CV10G-2, CV10G2-1310140, CV10G-S2, CV10GS2-1310190, CV20E-2, CV20E2-1320240, CV20E-S2, CV20ES2-1320290, CV20G-2, CV20G2-1310240, CV20G-S2, CV20GS2-1310290, CV21E-1322100, CV21E-2, CV21E2-1322140, CV21E-S2, CV21ES2-1322190, CV21G-2, CV21G2-1312140, CV21G-S2, CV21GS2-1312190, CV6E-2, CV6E2-1320040, CV6E-S2, CV6ES2-1320090, CV6G-2, CV6G2-1310040, CV6G-S2, CV6GS2-1310090, CVM10E-2, CVM10E2-1320440, CVM10E-S2, CVM10ES2-1320490, CVM10G-2, CVM10G2-1310440, CVM10G-S2, CVM10GS2-1310490, CVM20E-2, CVM20E2-1320540, CVM20E-S2, CVM20ES2-1320590, CVM20G-2, CVM20G2-1310540, CVM20G-S2, CVM20GS2-1310590, CVM21E-1322400...(Other models you can see in the webshop)		

motor protection circuit breakers



1

GEV No.	380940	Ref. No.	2000394
description	motor protection circuit breaker type GPS1B5AH setting range 2.5-4A DIN rail contacts screw clamp		
For models:	OLAX151, OLAX151EDX-1080725, OLAX151ELEFT-1080727, OLAX151-highspeed, OLAX160, OLAX160E-1080750, OLAX160E-1080751, OLAX160V-1080755, OLAX160V-1080756, OLAX160V-1081031, OLAX160V-1081032, OLAX210, OLAX210E-1081029, OLAX210E-1081030, OLAX220, OLAX220E-1080787, OLAX220E-1080788, OLAX220V-1080789, OLAX220V-1080790, OLAX230, OLAX230E-1080791, OLAX230E-1080792, OLAX230V-1080793, OLAX230V-1080794, OLAX240, OLAX240E-1080795, OLAX240E-1080796, OLAX240V-1080797, OLAX240V-1080798, OLAX250, OLAX250E-1080760, OLAX250E-1080761, OLAX250V-1080765, OLAX250V-1080766, OLAX300, OLAX300E-1080770, OLAX300E-1080771, OLAX300E-1081033, OLAX300E-1081035, OLAX300E-1081036, OLAX300LC, OLAX300LCE-1081034, OLAX300V-1080775, OLAX300V-1080776, OLAX310, OLAX310E-1081110, OLAX310E-1081111, OLAX310LC, OLAX310LCE-1081114, OLAX310LCE-1081115...(Other models you can see in the webshop)		

ISKRA (FANAL)

power contactors



1



GEV No.	380213	Ref. No.	15086
description	power contactor resistive load 20A 230VAC (AC3/400V) 8.5A/5.5kW main contacts 3NO auxiliary contacts 1NO connection screw connection type Fanal DSL7 10 type ISKRA K07M 10		
For models:	G12S, OLDS40-1081010, OLDS40D-1081011, OLDS40LS-1081012, OLDS40LSD-1081013, OLDS45, OLDS50, OLDS50-1081088, OLDS50D-1081089, OLDS50E-1081090, OLDS50ED-1081091, OLDS50-Neutra, OLDS50P-1081018, OLDS50PD-1081019, OLWD020H, OLElectron1000, OLElectron400, OLElectron500, OLELELECTRON1000-1081084, OLELELECTRON1000D-1081085, OLG600, OLGastro450, OLGastro500Plus, OLGastro500S, OLGastro750Plus, OLGastro750S, OLGRANUL900, OLG540, OLG545, OLG550, OLG550-1080705, OLG550D-1080706, OLG550E-1080730, OLG550ECO-1081014, OLG550ECOD-1081015, OLG550ED-1080731, OLG550-Neutra, OLG585, OLG585-1081016, OLG585D-1081017, OLG585-Neutra, OLH600, OLH600Electronic, OLHT11-1081071, OLHT11D-1081072, OLHT11ECO-1081070, OLHT-11-Neutra, OLHT11S, OLHT11S-Neutra, OLHT12-1081075...(Other models you can see in the webshop)		

LOVATO

power contactors



1

GEV No.	380855	Ref. No.	6A047200 826630300 BN826630300
description	power contactor resistive load 25A 230VAC (AC3/400V) 4.2kW main contacts 3NO auxiliary contacts 1NO		
For models:	40SEW, 40SEW-1825190, 41SEFR, 41SEFR-1826120, 61SEFR, 61SEFR-1826130, 710FRE-1077700, 712FRE-1077900, 720FRE-1077800, 722FRE-1078000, 725KB-E-1000200, 725KBE-1000200, 725KBEB-1000201, 725KBEM-1000210, 725KBEMB-1000211, 7BR-E100, 7BR-E105, 7BRF-E805, 7BRS-E100, 7BRS-E105, 9121PFRE-1204925, 9122PFRE-1104930, 9141PFRE-1204950, 921FRE, 921FRE-1292925, 921RFRE-1392925, 922RFRE-1192930, 922RFRE-1392930, 941FRE-1292950, 941RFRE-1392950, 96-04KBEC, 96-04KBEC-12901105, 9BR-E100, 9BR-E105, 9BR-E125, 9BRS-E100, 9BRS-E105, CV6E-1320000, CV6E2-1320040, CV6EB-1321000		
accessories for	380855		
	GEV No.	380055	Ref. No. —
	RC circuit voltage AC/DC suitable for BF09-32 rated 240V		
	GEV No.	380118	Ref. No. —
	auxiliary contact contacts 1NO/1NC AC1 10A for contactors BF series connection screw type G480/11		



1

GEV No.	380782	Ref. No.	6A047030 BN6A047030
description	power contactor resistive load 40A 230VAC (AC3/400V) 12.5kW main contacts 3NO connection screw connection		
For models:	911PEB-1192805, 911RPEB-1392890, 915PEB-1192800, 94KBE, 94KBE-1192870, 94KBEM-1192880, 94RKBEM-1392870, 94RKBEM-1392880		



MOELLER/EATON

power contactors



1

GEV No.	380550	Ref. No.	R65140550 R65140700
description	power contactor resistive load 20A 230VAC (AC3/400V) 9A/4kW main contacts 3NO auxiliary contacts 1NC connection screw connection type DILM9 01		
For models:	CCE042M, CCE051M, CCE071M, CCE101M, CCE102M, CCG071M, CCG101M, CCG102M, CKEP06, CKEP06B, CKEP10, CKEP10B, CKET06, CKET06B, CKET10B, CKGP06, CKGP06B, CKGP10, CKGP10B, CKGT06, CKGT06B, CKGT10B		

accessories for 380550



GEV No.	380555	Ref. No.	—
description	auxiliary contact contacts 2NO/2NC AC15 16A for contactors DILEM connection screw type DILA-XHI22		



GEV No.	380556	Ref. No.	—
description	auxiliary contact contacts 4NO AC15 16A for contactors DILM 7-32 connection screw type DILA-XHI40		



GEV No.	380557	Ref. No.	—
description	auxiliary contact contacts 4NC AC15 16A for contactors DILM 7-32 connection screw type DILA-XHI04		



GEV No.	380558	Ref. No.	—
description	auxiliary contact contacts 3NO/1NC AC15 16A for contactors DILM 7-32 connection screw type DILA-XHI31		



GEV No.	380559	Ref. No.	—
description	auxiliary contact contacts 1NO/3NC AC15 16A for contactors DILM 7-32 connection screw type DILA-XHI13		



GEV No.	380568	Ref. No.	—
description	RC circuit suitable for DILM 9-12 rated 110-240V		



1

GEV No.	381005	Ref. No.	R65140710
description	power contactor resistive load 35A 230VAC (AC3/400V) 17A/7.5kW main contacts 3NO auxiliary contacts 1NC connection screw connection type DILM 17-01		
For models:	CCE101M, CCE102M, CKEP06B, CKEP10, CKEP10B, CKET10, CKET10B		

overload switches



1

GEV No.	381006	Ref. No.	R65160760
description	overload switch connection screw setting range 1-1.6A type ZB12		
For models:	CCE101M, CCE102M, CKEP10, CKEP10B, CKGP10, CKGP10B		

auxiliary contacts



1

GEV No.	381007	Ref. No.	R65140730
description	auxiliary contact contacts 1NO/1NC AC15 10A for contactors connection screw type DILA-XHI11		
For models:	CKEP06, CKEP06B, CKEP10B, CKET06, CKET06B, CKET10B		



1

GEV No.	380565	Ref. No.	R65140740
description	auxiliary contact contacts 1NO/1NC AC15 10A for contactors DIL 17-32 connection screw type DILM 32-CHI11-S		
For models:	CKEP06, CKEP10, CKEP10B, CKET10		

SIEMENS

power contactors





1

GEV No.	380652	Ref. No.	LA65140380 LAR65140380
description	power contactor resistive load 22A 230VAC (AC3/400V) 9A/4kW main contacts 3NO auxiliary contacts 1NC connection screw connection type 3RT10-16-1AP02		
For models:	CKEP20, CKEP20B, CKEP21, CKEP21B, CKEP40, CKEP40B, CKGP20, CKGP20B, CKGP21, CKGP21B, CKGP40, CKGP40B, CKGT20, CKGT20B, CKGT21, CKGT21B, CKGT40, CKGT40B		





			
1			
GEV No.	380389	Ref. No.	CM187300
description	power contactor resistive load 22A 230VAC (AC3/400V) 9A/4kW main contacts 3NO auxiliary contacts 1NO connection screw connection type 3RT10-16-1AP01		
For models:	CPE60, CPE60DB, FQE41, FQE41L, FQE41L2, FQE61, FQE61L, FQE61L2, OCPE60, OCPE-60-12601900, OCPE-60-12601900MN, OFQE41, OFQE-41-12601510, OFQE-41-12601510MN, OFQE41L, OFQE61, OFQE-61-12601610, OFQE-61-12601610MN, OFQE61L		

			
1			
GEV No.	380646	Ref. No.	R65140400
description	power contactor resistive load 40A 230VAC (AC3/400V) 17A/7.5kW main contacts 3NO auxiliary contacts connection screw connection type 3RT10-25-1AL20		
For models:	CKEP20, CKEP20B, CKEP21, CKEP21B, CKEP40, CKEP40B, CKET20, CKET20B, CKET21, CKET21B, CKET40, CKET40B		

<h3>auxiliary contacts</h3> 			
1			
GEV No.	380653	Ref. No.	R65140420
description	auxiliary contact contacts 1NO/1NC AC15 3A for contactors 3RT101 connection screw connection type 3RH1911-1FA11		
For models:	CKEP20		

			
1			
GEV No.	380647	Ref. No.	R65140430
description	auxiliary contact contacts 1NO/1NC AC15 3A for contactors 3RT102 3 RT103 connection screw connection type 3RH1921-1EA11 resistive load 10A AC-12 10A		
For models:	CKEP20, CKEP20B, CKEP21, CKEP21B, CKEP40, CKEP40B, CKET20, CKET20B, CKET21, CKET21B, CKET40, CKET40B		

<h3>overload switches</h3> 			
1			
GEV No.	380659	Ref. No.	R65160570
description	overload switch setting range 0.7-1A connection screw type 3RU1116-0JB0 (AC3/400V) 0.25kW		
For models:	CKEP20, CKEP20B, CKEP21, CKEP21B, CKEP40, CKEP40B		

			
1			
GEV No.	380661	Ref. No.	LA65160620 LAR65160620
description	overload switch setting range 1.4-2.0A connection screw type 3RU1116-1BB0 (AC3/400V) 0.75kW		
For models:	CKEP20, CKEP21, CKEP21B, CKEP40, CKEP40B, CKGP20, CKGP20B, CKGP21, CKGP21B, CKGP40, CKGP40B		

<h3>motor protection circuit breakers</h3> 			
1			
GEV No.	382000	Ref. No.	R65160590
description	motor protection circuit breaker type 3RU1116-1EBO setting range 2.8-4A (AC3/400V) 1.5kW		
For models:	CKEP20B, CKGP20, CKGP20B, CKGP21, CKGP21B, CKGP40, CKGP40B		



ABL SURSUM

motor protection circuit breakers



1

GEV No.	380300	Ref. No.	2000390
description	motor protection circuit breaker type Mbs25-016 setting range 1-1.6A (AC3/400V) 0.55kW		
For models:	OLAX151, OLAX151EDX-1080725, OLAX151ELEF-1080727, OLAX151-highspeed, OLAX160, OLAX160E-1080750, OLAX160E-1080751, OLAX160V-1080755, OLAX160V-1080756, OLAX160V-1081031, OLAX160V-1081032, OLAX210, OLAX210E-1081029, OLAX210E-1081030, OLAX220, OLAX220E-1080787, OLAX220E-1080788, OLAX220V-1080789, OLAX220V-1080790, OLAX230, OLAX230E-1080791, OLAX230E-1080792, OLAX230V-1080793, OLAX230V-1080794, OLAX240, OLAX240E-1080795, OLAX240E-1080796, OLAX240V-1080797, OLAX240V-1080798, OLAX250, OLAX250E-1080760, OLAX250E-1080761, OLAX250V-1080765, OLAX250V-1080766, OLAX300, OLAX300E-1080770, OLAX300E-1080771, OLAX300E-1081033, OLAX300E-1081035, OLAX300E-1081036, OLAX300LC, OLAX300LCE-1081034, OLAX300V-1080775, OLAX300V-1080776, OLAX310, OLAX310E-1081110, OLAX310E-1081111, OLAX310LC, OLAX310LCE-1081114, OLAX310LCE-1081115...(Other models you can see in the webshop)		
accessories for	380300		
	GEV No.	380305	Ref. No. —
	auxiliary contact contacts 1NO/1NC HMS11		

relays



power relays



with DIN rail mounting

lateral



1

GEV No.	380336	Ref. No.	LA65170100 LAR65170100
description	power relays FINDER 230VAC 16A 2NO connection male faston 6.3mm DIN rail manuf. no. 62.82.8.230.0308		
For models:	CCG051M, CCG071M, CCG101M, CCG102M, CKGP06, CKGP06B, CKGP10, CKGP10B, CKGP20, CKGP20B, CKGP21, CKGP21B, CKGP40, CKGP40B		
accessories for	380336		
	GEV No.	380703	Ref. No. —
	adapter for flange mounting suitable for FINDER relay 62 series.		
	GEV No.	380811	Ref. No. —
	adapter with bracket mounting suitable for FINDER relay 62 series.		

accessories for	380336		
	GEV No.	380954	Ref. No. —
	adapter hole distance 54mm bracket mounting suitable for FINDER relay 62 series. L 41mm W 39mm H 49mm		
	GEV No.	381003	Ref. No. —
	adapter for DIN rail mounting suitable for FINDER relay 62 series.		
	GEV No.	381039	Ref. No. —
	adapter for DIN rail mounting suitable for FINDER relay 62 series.		

with bracket mounting



1

GEV No.	380139	Ref. No.	15620
description	power relays FINDER 230VAC 16A 2CO connection F6.3 bracket mounting dimensions 68x38.2x35.8mm manuf. no. 62.82.8.230.0000		
For models:	OLDS35, OLDS35-1081061, OLDS35D-1081062, OLDS35-Neutra, OLDS37, OLDS37-1081006, OLDS37-1081063, OLDS37D-1081007, OLDS37D-1081064, OLDS37LS-1081008, OLDS37LSD-1081009, OLDS37-Neutra, OLDS40, OLDS40-1081010, OLDS40-1081065, OLDS40D-1081011, OLDS40D-1081066, OLDS40E-1081067, OLDS40ED-1081068, OLDS40LS-1081012, OLDS40LSD-1081013, OLDS40-Neutra, OLDS50-Neutra, OLG35, OLG35D-1081000, OLG35-Neutra, OLG600, OLGastro450, OLGastro500Plus, OLGastro500S, OLGastro750Plus, OLGastro750S, OLG40, OLG45, OLG50, OLG50-1080705, OLG50D-1080706, OLG50E-1080730, OLG50ECO-1081014, OLG50ECOD-1081015, OLG50ED-1080731, OLG50-Neutra, OLG585, OLG585-1081016, OLG585D-1081017, OLG585-Neutra, OLHT11-1081071, OLHT11D-1081072, OLHT11ECO-1081070, OLHT-11-Neutra...(Other models you can see in the webshop)		



1

GEV No.	380403	Ref. No.	16047
description	power relays FINDER 230VAC 16A 3CO connection F6.3 bracket mounting manuf. no. 62.83.8.230.0500		
For models:	OLDS37-1081006, OLDS37D-1081007, OLDS37LS-1081008, OLDS37LSD-1081009, OLDS40-1081010, OLDS40D-1081011, OLDS40LS-1081012, OLDS40LSD-1081013, OLG35-1080702, OLG37, OLG37-1080700, OLG37D-1080707, OLG37LS-1081001, OLG37LSD-1081002, OLG37-Neutra, OLG40, OLG40-1080701, OLG40D-1080708, OLG40D-1081003, OLG40-Neutra, OLG45, OLG45LSD-1081004, OLG585, OLG585-1081016, OLG585D-1081017, OLG585-Neutra, OLLinear, OLStar		



1

GEV No.	380702	Ref. No.	6A001407 6A001408 BN6A001408
description	power relays FINDER 230VAC 16A 3NO connection male faston 6.3mm flange dimensions 36x38x68mm manuf. no. 62.83.8.230.0300 230V		



1





GEV No.	380185	Ref. No.	166560
description	power relays Italiana Relè 230VAC 30A 1NO connection F6.3 bracket mounting dimensions 36.5x32.2x51.8mm manuf. no. A10-230AC-FA		
For models:	KC41-210916400BDC, KTRNBT300122-2025130105DK, KTRNB-T300122A-20251301051G, OLSPABTV140-201724030CI4, OLSPABTV70-201717030CHY, ROLL-IN1P-211008120CJE, ROLL-IN1P-211008120CJG, ROLL-IN1PBT-211009120CJF, ROLL-IN2P-211016120CJL, ROLL-IN2P-211016120CJM, ROLL-IN2P-211016220CJN, ROLL-IN2P-211016220CJP, ROLL-IN2PMTN-211016220CJO, ROLL-INP1P-211008220CJH, ROLL-INP1P-211008220CJK, ROLL-INP1PBT-211009220CJI, ROLL-INP1PMTN-211008220CJJ		

with male contacts

female contact 2.0mm



1

GEV No.	380377	Ref. No.	6A047070 BN6A047070 FR995940
description	power relays FINDER 220-240VAC 10A 2CO connection F2 plug-in connection manuf. no. 55.32.8.230.0000 94.92.3 250V		
For models:	74-02NPEI, 7PN-EI50, CV10E-1320100, CV10EB-1321100, CV10G, CV10G-1310100, CV10G-2, CV10G2-1310140, CV10GB-1311100, CV10G-S, CV10GS-1310150, CV10G-S2, CV10GS2-1310190, CV20E-1320200, CV20EB-1321200, CV20G, CV20G-1310200, CV20G-2, CV20G2-1310240, CV20GB-1311200, CV20G-S, CV20GS-1310250, CV20G-S2, CV20GS2-1310290, CV21E-1322100, CV21ES2-1322190, CV21G-1312100, CV21GS2-1312190, CV6E-1320000, CV6E2-1320040, CV6EB-1321000, CV6G, CV6G-1310000, CV6G-2, CV6G2-1310040, CV6GB-1311000, CV6G-S, CV6GS-1310050, CV6G-S2, CV6GS2-1310090, CVM10E-1320400, CVM10G-1310400, CVM10G-1310410, CVM10GP-1310400, CVM20E-1320500, CVM20G-1310500, CVM21E-1322400, CVM21ES2-1322490, CV-M21G-1312400, CVM21GS2-1312490...(Other models you can see in the webshop)		
accessories for	380377		
	GEV No.	380341	Ref. No. —
	relay socket 4-pole contacts 12 300V voltage AC 6A Italiana Relè manuf. no. ZMD4		
	GEV No.	380378	Ref. No. —
	relay socket 2-pole 55/85 dimensions 70.5x30x27mm 250V voltage AC 10A FINDER manuf. no. 94.72		
	GEV No.	380384	Ref. No. 6A047074 A047074 BN6A047074
	relay socket 2-pole contacts male faston 2.8mm 250V voltage AC 10A W 23mm for		
	GEV No.	380399	Ref. No. —
	relay socket 4-pole dimensions 76.2x27x86.1mm 250V voltage AC 1A FINDER manuf. no. 94.94.3		

plug-in/print relays



1







GEV No.	380331	Ref. No.	5151300 MA5151300
description	print relay 24VAC 1CO at 250V 10A connection pins raster size 5mm		
accessories for	380331		
	GEV No.	380340	Ref. No. —
	relay socket dimensions 62x36x15mm 250V voltage AC 10A Italiana Relè manuf. no. ZMEM/5		

Table continues overleaf



accessories for	380331		
	GEV No.	380505	Ref. No. —
	relay socket 2CO 40.52 dimensions 81.9x15.5x75mm 250V voltage AC 10A FINDER manuf. no. 95.95.3		
	GEV No.	381181	Ref. No. 3006079
	relay socket 2-pole 40.51/40.52/40.61 connection screw clamp dimensions 15.8x78.6mm 250V voltage AC 10A FINDER manuf. no. 95.75		

relay sockets

			
1			
GEV No.	381181	Ref. No.	3006079
description	relay socket 2-pole 40.51/40.52/40.61 connection screw clamp dimensions 15.8x78.6mm 250V voltage AC 10A FINDER manuf. no. 95.75		
For models:	OLAX151, OLAX151EDX-1080725, OLAX151ELEF-1080727, OLAX151-highspeed, OLAX160, OLAX160E-1080750, OLAX160E-1080751, OLAX160V-1080755, OLAX160V-1080756, OLAX160V-1081031, OLAX160V-1081032, OLAX210, OLAX210E-1081029, OLAX210E-1081030, OLAX220, OLAX220E-1080787, OLAX220E-1080788, OLAX220V-1080789, OLAX220V-1080790, OLAX230, OLAX230E-1080791, OLAX230E-1080792, OLAX230V-1080793, OLAX230V-1080794, OLAX240, OLAX240E-1080795, OLAX240E-1080796, OLAX240V-1080797, OLAX240V-1080798, OLAX250, OLAX250E-1080760, OLAX250E-1080761, OLAX250V-1080765, OLAX250V-1080766, OLAX300, OLAX300E-1080770, OLAX300E-1080771, OLAX300E-1081033, OLAX300E-1081035, OLAX300E-1081036, OLAX300LC, OLAX300LCE-1081034, OLAX300V-1080775, OLAX300V-1080776, OLAX310, OLAX310E-1081110, OLAX310E-1081111, OLAX310LC, OLAX310LCE-1081114, OLAX310LCE-1081115...(Other models you can see in the webshop)		
accessories for	381181		
	GEV No.	381455	Ref. No. —
	support bracket		

level relays

GICAR

			
1			
GEV No.	401224	Ref. No.	6A001423
description	level relay 230V connection F6.3 type RL30/3ES/F/G		
For models:	94-04PEI100L, 94-04PEI100L-12901765, 94-04PEI110L-12901765BN, 94-04PEI150L, 94-04PEI150L-12901767, 94-04PEI150L-12901767BN, 9PN-EI100, 9PN-EI150		

time relays

time relays



GEV No.	381421	Ref. No.	R65090450
description	time relay CROUZET EMAR7 88 829 117 time range 0.1s-20h 240VAC 5A NO connection grip connection		
For models:	CCG051M, CCG071M, CCG101M, CCG102M		



GEV No.	380489	Ref. No.	LA65090480 LAR65090480
description	time relay CROUZET MUR1-88826105 time range 0.1s-100h 24-240VAC/24VDC 8A mounting measurements DIN railmm 1CO connection grip connection		



GEV No.	380386	Ref. No.	6A047065 BN6A047065
description	time relay CROUZET MUS2-88826004 time range 0.1s-100h 24-240VAC 0.7A 1NO connection grip connection		
For models:	CV10E-1320100, CV10G-1310100, CV20E-1320200, CV20G-1310200, CV21E-1322100, CV21ES2-1322190, CV21G-1312100, CV21GS2-1312190, CV6E-1320000, CV6E2-1320040, CV6G-1310000, CVM10E-1320400, CVM10G-1310400, CVM10G-1310410, CVM10GP-1310400, CVM20E-1320500, CVM20G-1310500, CVM21E-1322400, CVM21ES2-1322490, CVM21G-1312400, CVM21GS2-1312490, CVM6E-1320300, CVM6G-1310300, CVM6G-1310310, CVP10E-1320700, CVP10G-1310700, CVP10GP-1310700, CVP20E-1320800, CVP20G-1310800, CVP21E-1322700, CVP21ES2-1322790, CVP21GS-1312750, CVP21GS2-1312790, CVP6E-1320600, CVP6G-1310600		



transformers

open transformers

with clamp terminal



1

GEV No.	401189	Ref. No.	6A047047 BN6A047047
description	transformer 20VA		
For models:	ECVM10ES2, ECVM10ES2-1324290, ECVM10ES2-1326120, ECVM-10GS2, ECVM10GS2-1314290, ECVM10GS2-1316120, ECVM20ES2, ECVM20ES2-1324390, ECVM20ES2-1326140, ECVM20GS2, ECVM-20GS2-1314390, ECVM20GS2-1316140, ECVM21ES2, ECVM6ES2, ECVM6ES2-1324190, ECVM6ES2-1326100, ECVM6ES2-1326100H, ECVM6GS2, ECVM6GS2-1314190, ECVM6GS2-1316100, ECVP10ES2, ECVP10ES2-1324690, ECVP10ES2-1326200, ECVP10GS2, ECVP10GS2-1314690, ECVP10GS2-1316200, ECVP20ES2, ECVP20ES2-1324790, ECVP20ES2-1326220, ECVP20GS2, ECVP20GS2-1314790, ECVP20GS2-1316220, ECVP21ES2, ECVP21ES2-1324890, ECVP21ES2-1326240, ECVP21GS2, ECVP21GS2-1314890, ECVP21GS2-1316240, ECVP6ES2, ECVP6ES2-1324590, ECVP6ES2-1326180, ECVP6GS2, ECVP6GS2-1314590, ECVP6GS2-1316180, NECVM10ES2, NECVM10ES2-1327290, NECVM10ES2-1328120, NECVM10ES2-1328120H, NECVM10GS2, NECVM10GS2-1317290...(Other models you can see in the webshop)		

encapsulated transformers

with screw connection



1

GEV No.	400127	Ref. No.	LA65180430 LAR65180430
description	transformer primary 230VAC secondary 12VAC 40VA secondary 3.2A H 63mm L 75mm W 78mm connection 2-wire connection systems 50/60Hz moulded		
For models:	CKEP10, CKEP10B, CKEP20, CKEP20B, CKEP21, CKEP21B, CKEP40, CKEP40B, CKET10, CKET10B, CKET20, CKET20B, CKET21, CKET21B, CKET40, CKET40B, CKGP10, CKGP10B, CKGP20, CKGP20B, CKGP21, CKGP21B, CKGP40, CKGP40B, CKGT10B, CKGT20, CKGT20B, CKGT21, CKGT21B, CKGT40, CKGT40B		

PMA



1

GEV No.	400126	Ref. No.	LA65180420 LAR65180420
description	transformer primary 230VAC secondary 12VAC 20VA secondary 2.1A connection screw 50Hz		
For models:	CCE071M, CCE101M, CCE102M, CCG071M, CCG101M, CCG102M, CKEP06, CKEP06B, CKEP10, CKEP10B, CKEP20, CKEP20B, CKEP21, CKEP21B, CKEP40, CKEP40B, CKET06, CKET06B, CKET10, CKET10B, CKET20, CKET20B, CKET21, CKET21B, CKET40, CKET40B, CKGP06, CKGP06B, CKGP10, CKGP10B, CKGP20, CKGP20B, CKGP21, CKGP21B, CKGP40, CKGP40B, CKGT06, CKGT06B, CKGT10B, CKGT20, CKGT20B, CKGT21, CKGT21B, CKGT40, CKGT40B		



1

GEV No.	379054	Ref. No.	168305
description	transformer primary 230VAC secondary 12VAC 3VA secondary 0.25A H 40mm L 45mm W 50mm connection screw 50/60Hz type 153/M		
For models:	KBT40-21091640, KC41-210916400BDC, KR41-210906400BFA, KTAP01-BASE-20220901044U, KTAP02-BASE-20221301048K, KTAP02BT-BASE-2022630105KW, KTAP03-BASE-2022180109UA, KTAP04-2022230109X0, KTAP04-BASE-2022230109RY, KTAR01, KTAR01N, KTAR02, KTAR02N, KTAR03, KTAR03N, KTAR04, KTAR04N, KTN40-21090640, KTR21-202108010BL5, KTR2-202108010BFC, KTR2A-202108010BGP, KTR3-202113010BHF, KTR32A-202113010BLQ, KTR34-202113010BLW, KTR3A-202113010BFW, KTR4-202117010BLG, KTR42-202117010BMO, KTR42A-202117010BM6, KTR44-202117010BMB, KTR4A-202117010BFF, KTR5-202122010BG2, KTR52-202122010BNK, KTR54-202122010BGC, KTR54A-202122010BNP, KTR5A-202122010BL3, KTRP3-202611010C2F, KTRP34-20261101096L, KTRP34A-20261101096K, KTRP3A-202611010C1L, KTRP4-202615010BNQ, KTRP4A-202615010BNR, KTRP52A-202620010B05, KTRN200012-202010050495, KTRN200012A-2020100507UJ, KTRN200013-2020100507UV, KTRN200013A-2020100507UU, KTRN200014-2020100507UM, KTRN200014A-2020100507UL, KTRN200015-2020100507UR, KTRN200015A-2020100507UT...(Other models you can see in the webshop)		



electronic controllers

SHANGFANG

accessories



GEV No.	379054	Ref. No.	168305
description	transformer primary 230VAC secondary 12VAC 3VA secondary 0.25A H 40mm L 45mm W 50mm connection screw 50/60Hz type 153/M		

For models: KBT40-21091640, KC41-210916400BDC, KR41-210906400BFA, KTAP01-BASE-20220901044U, KTAP02-BASE-20221301048K, KTAP02BT-BASE-2022630105KW, KTAP03-BASE-2022180109UA, KTAP04-2022230109X0, KTAP04-BASE-2022230109RY, KTAR01, KTAR01N, KTAR02, KTAR02N, KTAR03, KTAR03N, KTAR04, KTAR04N, KTN40-21090640, KTR21-202108010BL5, KTR22-202108010BFC, KTR2A-202108010BGP, KTR3-202113010BHF, KTR32A-202113010BLQ, KTR34-202113010BLW, KTR3A-202113010BFW, KTR4-202117010BLG, KTR42-202117010BMO, KTR42A-202117010BMM6, KTR44-202117010BMB, KTR4A-202117010BFF, KTR5-202122010BG2, KTR52-202122010BNK, KTR54-202122010BGC, KTR54A-202122010BNP, KTR5A-202122010BL3, KTRP3-202611010C2F, KTRP34-20261101096L, KTRP34A-20261101096K, KTRP3A-202611010C1L, KTRP4-202615010BNQ, KTRP4A-202615010BNR, KTRP52A-202620010BOS, KTRN200012-202010050495, KTRN200012A-2020100507UK, KTRN200013-2020100507UV, KTRN200013A-2020100507UU, KTRN200014-2020100507UM, KTRN200014A-2020100507UL, KTRN200015-2020100507UR, KTRN200015A-2020100507UT...(Other models you can see in the webshop)

probes

universal probes

temperature probes



GEV No.	379130 ¹	Ref. No.	R65325000
description	temperature probe Pt100 cable Vetrotex probe -200 up to +600°C cable -50 up to +350°C probe ø6x100mm cable length 1.4m without screw connection 3-wire resistance at 0°C 100Ohm		
For models:	CKEP06, CKEP06B, CKEP10, CKEP10B, CKEP20, CKEP20B, CKEP21, CKEP21B, CKEP40, CKEP40B, CKET06, CKET06B, CKET10, CKET10B, CKET20, CKET20B, CKET21, CKET21B, CKET40, CKET40B, CKGP06, CKGP06B, CKGP10, CKGP10B, CKGP20, CKGP20B, CKGP21, CKGP21B, CKGP40, CKGP40B, CKGT06, CKGT06B, CKGT10B, CKGT20, CKGT20B, CKGT21, CKGT21B, CKGT40, CKGT40B		

¹3-wire

GEV No.	379050 ¹	Ref. No.	R65325010
description	temperature probe Pt100 cable Vetrotex probe -200 up to +600°C cable -50 up to +350°C probe ø6x100mm cable length 2.7m without screw connection 3-wire		
For models:	CKEP21, CKEP21B, CKEP40, CKEP40B, CKET21, CKET21B, CKET40, CKET40B, CKGP21, CKGP21B, CKGP40, CKGP40B, CKGT21, CKGT21B, CKGT40, CKGT40B		

¹3-wire

GEV No.	379052	Ref. No.	167201
description	temperature probe PTC 1kOhm cable silicone probe -50 up to +150°C cable -50 up to +180°C probe ø6x40mm cable length 1.5m without screw connection 2-wire		
For models:	KBT40-21091640, KC41-210916400BDC, KR41-210906400BFA, KTN40-21090640		

GEV No.	381363	Ref. No.	LAR65320220
description	temperature probe thermocouple K (NiCr-Ni) probe -50 up to 1150°C cable -50 up to +180°C cable length 1.5m thread M10x1 adapter length 93mm adapter ø 6mm cable colours silver/yellow probe L 90/14mm probe ø 6/3mm		

producer-specific probes

probes

GEV No.	379936	Ref. No.	3103275 BN3103275
description	temperature probe Pt100 cable Vetrotex probe -200 up to +600°C cable -50 up to +350°C connection 2-wire thread probe ø4-6x100mm cable length 1m		
For models:	CV20E-1320200, CV20E2-1320240, CV20EB-1321200, CV20ES-1320250, CV20ES2-1320290, CV20G, CV20G-1310200, CV20G-2, CV20G2-1310240, CV20GB-1311200, CV20G-S, CV20GS-1310250, CV20G-S2, CV20GS2-1310290, CV21E, CV21E-1322100, CV21E-2, CV21E2-1322140, CV21E-S, CV21ES-1322150, CV21E-S2, CV21ES2-1322190, CV21G, CV21G-1312100, CV21G-2, CV21G2-1312140, CV21G-S, CV21GS-1312150, CV21G-S2, CV21GS2-1312190, CVM20E, CVM20E-1320500, CVM20E-2, CVM20E2-1320540, CVM20E-S, CVM20ES-1320550, CVM20E-S2, CVM20ES2-1320590, CVM20G, CVM20G-1310500, CVM20G-2, CVM20G2-1310540, CVM20G-S, CVM20GS-1310550, CVM20G-S2, CVM20GS2-1310590, CVM21E, CVM21E-1322400, CVM21E-2, CVM21E2-1322440...(Other models you can see in the webshop)		

GEV No.	379935	Ref. No.	3103270 BN3103270
description	temperature probe Pt100 cable Vetrotex probe -200 up to +600°C cable -50 up to +350°C connection 2-wire thread probe ø6x100mm cable length 0.8m		
For models:	CMV6E52-1320392, CV10E, CV10E-1320100, CV10E-1320110, CV10E-2, CV10E2-1320140, CV10EB-1321100, CV10E-S, CV10ES-1320150, CV10E-S2, CV10ES2-1320190, CV10G, CV10G-1310100, CV10G-2, CV10G2-1310140, CV10GB-1311100, CV10G-S, CV10GS-1310150, CV10G-S2, CV10GS2-1310190, CV20E, CV20E-1320200, CV20E-2, CV20E2-1320240, CV20E-S, CV20ES-1320250, CV20E-S2, CV20ES2-1320290, CV6E, CV6E-1320000, CV6E-1320010, CV6E-1320050, CV6E-2, CV6E2-1320040, CV6EB-1321000, CV6E-S, CV6E-S2, CV6ES2-1320090, CV6G, CV6G-1310000, CV6G-1310010, CV6G-2, CV6G2-1310040, CV6GB-1311000, CV6G-S, CV6GS-1310050, CV6G-S2, CV6GS2-1310090, CVM10E, CVM10E-1320400...(Other models you can see in the webshop)		

GEV No.	379937	Ref. No.	3103282 BN3103282
description	temperature probe thermocouple K (NiCr-Ni) cable PTFE probe -50 up to 1150°C cable -40 up to +250°C connection 2-wire thread probe ø4x120mm cable length 2.4m -40 up to +250°C		
For models:	ECVM10ES2, ECVM10ES2-1324290, ECVM10ES2-1324290MN, ECVM10ES2-1326120, ECVM10GS2, ECVM10GS2-1314290, ECVM10GS2-1316120, ECVM20ES2, ECVM20ES2-1324390, ECVM20ES2-1326140, ECVM20GS2, ECVM20GS2-1314390, ECVM20GS2-1316140, ECVM21ES2, ECVM21ES2-1324490, ECVM21ES2-1326160, ECVM21GS2, ECVM21GS2-1314490, ECVM21GS2-1316160, ECVM6ES2, ECVM6ES2-1324190, ECVM6ES2-1326100, ECVM6ES2-1326100H, ECVM6GS2, ECVM6GS2-1314190, ECVM6GS2-1316100, ECVP10ES2, ECVP10ES2-1324690, ECVP10ES2-1326200, ECVP10GS2, ECVP10GS2-1314690, ECVP10GS2-1316200, ECVP20ES2, ECVP20ES2-1324790, ECVP20ES2-1326220, ECVP20GS2, ECVP20GS2-1314790, ECVP20GS2-1316220, ECVP21ES2, ECVP21ES2-1324890, ECVP21ES2-1326240, ECVP21GS2, ECVP21GS2-1314890, ECVP21GS2-1316240, ECVP6ES2, ECVP6ES2-1324590, ECVP6ES2-1326180, ECVP6GS2, ECVP6GS2-1314590, ECVP6GS2-1316180...(Other models you can see in the webshop)		

GEV No.	379510	Ref. No.	LA65321102 LAR65321100
description	core temperature probe thermocouple K (NiCr-Ni) cable PTFE probe -40 up to +250°C cable -40 up to +250°C connection 6-pin connector probe ø3.5x90mm thread cable length 1.1m handle ømm handle length 90mm		
For models:	CKET06, CKET06B, CKET10, CKET10B, CKET20, CKET20B, CKET21, CKET21B, CKET40, CKET40B, CKGT06, CKGT06B, CKGT10, CKGT10B, CKGT20, CKGT20B, CKGT21, CKGT21B, CKGT40, CKGT40B		

GEV No.	379773 ¹	Ref. No.	LAR65321120
description	core temperature probe thermocouple K (NiCr-Ni) cable PTFE probe -40 up to +250°C cable -40 up to +250°C connection plug probe ø3.5x90mm thread cable length 1.1m handle ømm handle length 90mm		
For models:	CKEP06, CKEP06B, CKEP10, CKEP10B, CKEP20, CKEP20B, CKEP21, CKEP21B, CKEP40, CKEP40B, CKGP06, CKGP06B, CKGP10, CKGP10B, CKGP20, CKGP20B, CKGP21, CKGP21B, CKGP40, CKGP40B		

¹multipoint probe

core probes



GEV No.	379939	Ref. No.	3103280 BN3103280			
description	core temperature probe Pt100 cable PTFE probe -40 up to +250°C cable -40 up to +250°C connection plug probe ø4x100mm thread cable length 1.25m handle ø 10mm handle length 90/100mm					
For models:	CMV6ES2-1320392, CV10E-1320100, CV10E-2, CV10EB-1321100, CV10E-S, CV10ES-1320150, CV10E-S2, CV10ES2-1320190, CV10G-1310100, CV10GB-1311100, CV10G-S, CV10GS-1310150, CV10G-S2, CV10GS2-1310190, CV20E-1320200, CV20E-2, CV20EB-1321200, CV20E-S, CV20ES-1320250, CV20E-S2, CV20ES2-1320290, CV20G-1310200, CV20GB-1311200, CV20G-S, CV20GS-1310250, CV20G-S2, CV20GS2-1310290, CV21E-1322100, CV21E-S, CV21ES-1322150, CV21E-S2, CV21ES2-1322190, CV21G-S, CV21GS-1312150, CV21G-S2, CV21GS2-1312190, CV6E-1320000, CV6E-1320050, CV6E-2, CV6E2-1320040, CV6EB-1321000, CV6E-S, CV6E-S2, CV6ES2-1320090, CV6G-1310000, CV6GB-1311000, CV6G-S, CV6GS-1310050, CV6G-S2, CV6GS2-1310090...(Other models you can see in the webshop)					
accessories for	379939					
		<table border="1"> <tr> <td>GEV No.</td> <td>379938</td> <td>Ref. No.</td> <td>3103285 BN3103285</td> </tr> </table>	GEV No.	379938	Ref. No.	3103285 BN3103285
GEV No.	379938	Ref. No.	3103285 BN3103285			
	female connector 4-pole					

accessories

plugs/bushes

GEV No.	378016	Ref. No.	R65320920
description	female connector 4-pole		
For models:	CKEP06, CKEP06B, CKEP10, CKEP10B, CKEP20, CKEP20B, CKEP21, CKEP21B, CKEP40, CKEP40B, CKGP06, CKGP06B, CKGP10, CKGP10B, CKGP20, CKGP20B, CKGP21, CKGP21B, CKGP40, CKGP40B		

GEV No.	379938	Ref. No.	3103285 BN3103285
description	female connector 4-pole		
For models:	CMV6ES2-1320392, CV10E-1320100, CV10E-2, CV10EB-1321100, CV10E-S, CV10ES-1320150, CV10E-S2, CV10ES2-1320190, CV10G-1310100, CV10GB-1311100, CV10G-S, CV10GS-1310150, CV10G-S2, CV10GS2-1310190, CV20E-1320200, CV20E-2, CV20EB-1321200, CV20E-S, CV20ES-1320250, CV20E-S2, CV20ES2-1320290, CV20G-1310200, CV20GB-1311200, CV20G-S, CV20GS-1310250, CV20G-S2, CV20GS2-1310290, CV21E-1322100, CV21E-S, CV21ES-1322150, CV21E-S2, CV21ES2-1322190, CV21G-S, CV21GS-1312150, CV21G-S2, CV21GS2-1312190, CV6E-1320000, CV6E-1320050, CV6E-2, CV6E2-1320040, CV6EB-1321000, CV6E-S, CV6E-S2, CV6ES2-1320090, CV6G-1310000, CV6GB-1311000, CV6G-S, CV6GS-1310050, CV6G-S2, CV6GS2-1310090...(Other models you can see in the webshop)		

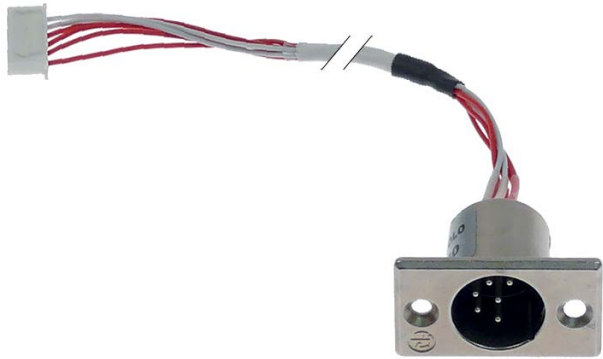

GEV No.	381462	Ref. No.	LA65321360
description	female connector with cable 6-pole for combi-steamer L 1000mm		



GEV No.	379940	Ref. No.	3103290 BN3103290
description	lid		
For models:	CMV6ES2-1320392, CV10E-1320100, CV10E-2, CV10EB-1321100, CV10E-S, CV10ES-1320150, CV10E-S2, CV10ES2-1320190, CV10G-1310100, CV10GB-1311100, CV10G-S, CV10GS-1310150, CV10G-S2, CV10GS2-1310190, CV20E-1320200, CV20E-2, CV20EB-1321200, CV20E-S, CV20ES-1320250, CV20E-S2, CV20ES2-1320290, CV20G-1310200, CV20GB-1311200, CV20G-S, CV20GS-1310250, CV20G-S2, CV20GS2-1310290, CV21E-1322100, CV21E-S, CV21ES-1322150, CV21E-S2, CV21ES2-1322190, CV21G-S, CV21GS-1312150, CV21G-S2, CV21GS2-1312190, CV6E-1320000, CV6E-1320050, CV6E-2, CV6E2-1320040, CV6EB-1321000, CV6E-S, CV6E-S2, CV6ES2-1320090, CV6G-1310000, CV6GB-1311000, CV6G-S, CV6GS-1310050, CV6G-S2, CV6GS2-1310090...(Other models you can see in the webshop)		



GEV No.	378017	Ref. No.	R65321020
description	lid for plug contact		
For models:	CKEP06, CKEP06B, CKEP10, CKEP10B, CKEP20, CKEP20B, CKEP21, CKEP21B, CKEP40, CKEP40B, CKET06, CKET06B, CKET10, CKET10B, CKET20, CKET20B, CKET21, CKET21B, CKET40, CKET40B, CKGP06, CKGP06B, CKGP10, CKGP10B, CKGP20, CKGP20B, CKGP21, CKGP21B, CKGP40, CKGP40B, CKGT06, CKGT06B, CKGT10, CKGT10B, CKGT20, CKGT20B, CKGT21, CKGT21B, CKGT40, CKGT40B		

miscellaneous



GEV No.	379856	Ref. No.	R86020420
description	bag for core temperature probe		
For models:	CKEP06, CKEP06B, CKEP10, CKEP10B, CKEP20, CKEP20B, CKEP21, CKEP21B, CKEP40, CKEP40B, CKET06, CKET06B, CKET10, CKET10B, CKET20, CKET20B, CKET21, CKET21B, CKET40, CKET40B, CKGP06, CKGP06B, CKGP10, CKGP10B, CKGP20, CKGP20B, CKGP21, CKGP21B, CKGP40, CKGP40B, CKGT06, CKGT06B, CKGT10, CKGT10B, CKGT20, CKGT20B, CKGT21, CKGT21B, CKGT40		

electronics

frequency converters



GEV No.	403841	Ref. No.	LAR65140890 R65140830
description	frequency converter with heat sink for combi-steamer L 135mm W 135mm 800W ECS P0010205-0		
For models:	CKET10, CKET10B, CKET20, CKET20B, CKET21, CKET21B, CKET40, CKET40B, CKGT10B, CKGT20, CKGT20B, CKGT21, CKGT21B, CKGT40, CKGT40B		

PCBs

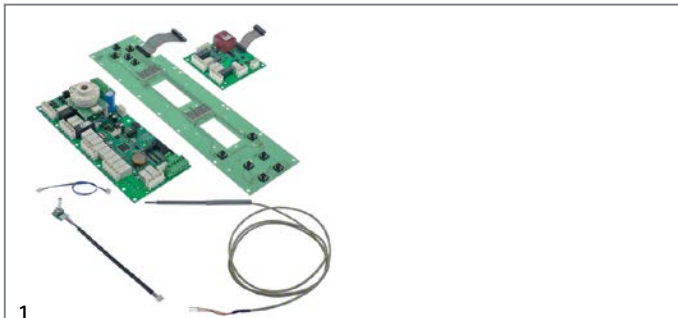

GEV No.	403498	Ref. No.	R65302160
description	keypad PCB combi-steamer with steam generator suitable for HME/HVE/HVG/HMG suitable for LAINOX 3 type K probes		
For models:	CKEP06B, CKEP10B, CKEP20B, CKEP21B, CKEP40B, CKGP06B, CKGP10B, CKGP20B, CKGP21B, CKGP40B		
spare parts for	403498		
	GEV No.	379130	Ref. No. R65325000
	temperature probe Pt100 cable Vetrotex probe -200 up to +600°C cable -50 up to +350°C probe ø6x100mm cable length 1.4m without screw connection 3-wire resistance at 0°C 1000hm		
	GEV No.	381363	Ref. No. LAR65320220
	temperature probe thermocouple K (NiCr-Ni) probe -50 up to 1150°C cable -50 up to +180°C cable length 1.5m thread M10x1 adapter length 93mm adapter ø 6mm cable colours silver/yellow probe L 90/14mm probe ø 6/3mm		
accessories for	403498		
	GEV No.	381363	Ref. No. LAR65320220
	temperature probe thermocouple K (NiCr-Ni) probe -50 up to 1150°C cable -50 up to +180°C cable length 1.5m thread M10x1 adapter length 93mm adapter ø 6mm cable colours silver/yellow probe L 90/14mm probe ø 6/3mm		

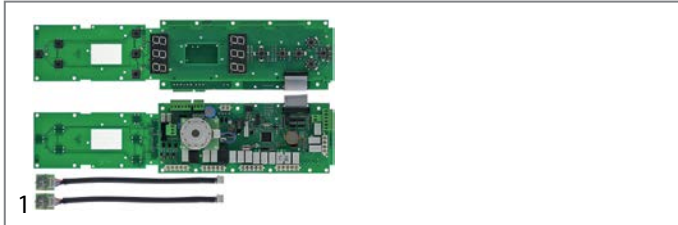

GEV No.	403829	Ref. No.	LAR65302100
description	keypad PCB for combi-steamer L 437mm W 103mm		

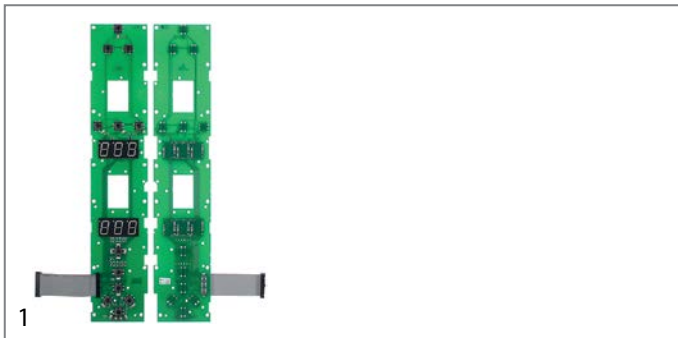

GEV No.	403823	Ref. No.	LA65302240 LAR65302240
description	keypad PCB for combi-steamer L 443mm W 83mm		



GEV No.	401192	Ref. No.	3103249 BN3103249
description	main PCB		
For models:	ECVM10ES2, ECVM10ES2-1324290, ECVM10ES2-1324290MN, ECVM10ES2-1326120, ECVM10GS2, ECVM10GS2-1314290, ECVM10GS2-1316120, ECVM20ES2, ECVM20ES2-1324390, ECVM20ES2-1326140, ECVM20GS2, ECVM20GS2-1314390, ECVM20GS2-1316140, ECVM21ES2, ECVM21ES2-1324490, ECV-M21ES2-1326160, ECV21GS2-1314490, ECV21GS2-1316160, ECV6ES2, ECV6ES2-1324190, ECV6ES2-1326100, ECV6ES2-1326100H, ECV6GS2, ECV6GS2-1314190, ECV6GS2-1316100, ECV10ES2, ECV10ES2-1324690, ECV10ES2-1326200, ECV10GS2, ECV10GS2-1314690, ECV10GS2-1316200, ECV20ES2, ECV20ES2-1324790, ECV20ES2-1326220, ECV20GS2, ECV20GS2-1314790, ECV20GS2-1316220, ECV21ES2, ECV21ES2-1324890, ECV21ES2-1326240, ECV21GS2, ECV21GS2-1314890, ECV21GS2-1316240, ECV6ES2, ECV6ES2-1324590, ECV6ES2-1326180, ECV6GS2, ECV6GS2-1314590, ECV6GS2-1316180, NECVM10ES2...(Other models you can see in the webshop)		

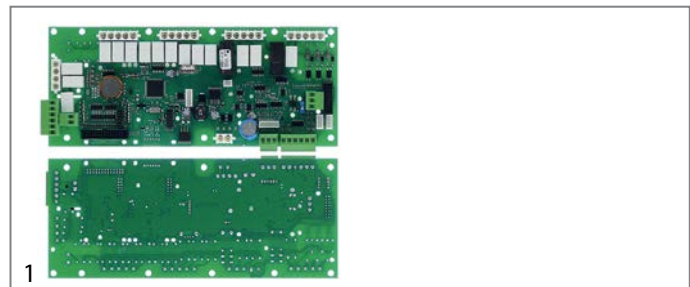

GEV No.	403824	Ref. No.	LA65302250 LAR65302250
description	main PCB for combi-steamer L 250mm W 103mm		

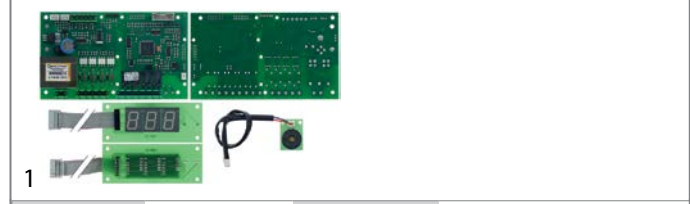

GEV No.	401195	Ref. No.	3103245 3198400 BN3103245
description	PCB combi-steamer CV10E complete without potentiometer		
For models:	CMV6ES2-1320392, CV10E, CV10E-1320100, CV10E-1320110, CV10E-2, CV10E2-1320140, CV10EB-1321100, CV10E-S, CV10ES-1320150, CV10E-S2, CV10ES2-1320190, CV10G, CV10G-1310100, CV10G-2, CV10G2-1310140, CV10GB-1311100, CV10G-S, CV10GS-1310150, CV10G-S2, CV10GS2-1310190, CV20E, CV20E-1320200, CV20E-2, CV20E2-1320240, CV20EB-1321200, CV20E-S, CV20ES-1320250, CV20E-S2, CV20ES2-1320290, CV20G, CV20G-1310200, CV20G-2, CV20G2-1310240, CV20GB-1311200, CV20G-S, CV20GS-1310250, CV20G-S2, CV20GS2-1310290, CV21E, CV21E-1322100, CV21E-2, CV21E2-1322140, CV21E-S, CV21ES-1322150, CV21E-S2, CV21ES2-1322190, CV21G, CV21G-1312100, CV21G-2, CV21G2-1312140...(Other models you can see in the webshop)		



1

GEV No.	402825	Ref. No.	R65301480
description	PCB combi-steamer GEMT L 130mm W 86mm new edition level control steam generator EVCO		
For models:	CKEP06B, CKEP10B, CKEP20B, CKEP21B, CKEP40B, CKGP06B, CKGP10B, CKGP20B, CKGP21B, CKGP40B		

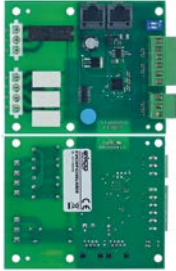

1

GEV No.	403668	Ref. No.	LA65302530 LAR65302530
description	PCB combi-steamer NABOO L 103mm W 85mm suitable for LAINOX		

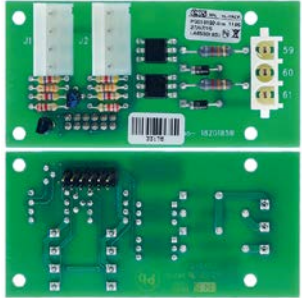

1

GEV No.	403828	Ref. No.	LA65301950 LAR65301950
description	PCB for combi-steamer L 85mm W 42mm		



1

GEV No.	401193	Ref. No.	3103246 BN3103246
description	PCB HACCP interface		
For models:	ECVM10ES2, ECVM10ES2-1324290, ECVM10ES2-1324290MN, ECVM10ES2-1326120, ECVM10GS2, ECVM10GS2-1314290, ECVM10GS2-1316120, ECVM20ES2, ECVM20ES2-1324390, ECVM20ES2-1326140, ECVM20GS2, ECVM20GS2-1314390, ECVM20GS2-1316140, ECVM21ES2, ECVM21ES2-1324490, ECVM21ES2-1326160, ECVM21GS2-1314490, ECVM21GS2-1316160, ECVM6ES2, ECVM6ES2-1324190, ECVM6ES2-1326100, ECVM6ES2-1326100H, ECVM6GS2, ECVM6GS2-1314190, ECVM6GS2-1316100, ECVP10ES2, ECVP10ES2-1324690, ECVP10ES2-1326200, ECVP10GS2, ECVP10GS2-1314690, ECVP10GS2-1316200, ECVP20ES2, ECVP20ES2-1324790, ECVP20ES2-1326220, ECVP20GS2, ECVP20GS2-1314790, ECVP20GS2-1316220, ECVP21ES2, ECVP21ES2-1324890, ECVP21ES2-1326240, ECVP21GS2, ECVP21GS2-1314890, ECVP21GS2-1316240, ECVP6ES2, ECVP6ES2-1324590, ECVP6ES2-1326180, ECVP6GS2, ECVP6GS2-1314590, ECVP6GS2-1316180, NECVM10ES2...(Other models you can see in the webshop)		



1

GEV No.	402924	Ref. No.	3103241 BN3103241
description	PCB L 83mm W 74mm suitable for OLIS		
For models:	CMV6ES2-1320392, CV10E, CV10E-1320100, CV10E-1320110, CV10E-2, CV10E2-1320140, CV10EB-1321100, CV10E-S, CV10ES-1320150, CV10E-S2, CV10ES2-1320190, CV10G, CV10G-1310100, CV10G-2, CV10G2-1310140, CV10GB-1311100, CV10G-S, CV10GS-1310150, CV10G-S2, CV10GS2-1310190, CV20E, CV20E-1320200, CV20E-2, CV20E2-1320240, CV20EB-1321200, CV20E-S, CV20ES-1320250, CV20E-S2, CV20ES2-1320290, CV20G, CV20G-1310200, CV20G-2, CV20G2-1310240, CV20GB-1311200, CV20G-S, CV20GS-1310250, CV20G-S2, CV20GS2-1310290, CV21E, CV21E-1322100, CV21E-2, CV21E2-1322140, CV21E-S, CV21ES-1322150, CV21E-S2, CV21ES2-1322190, CV21G, CV21G-1312100, CV21G-2, CV21G2-1312140...(Other models you can see in the webshop)		

1

GEV No.	402973	Ref. No.	R63130050
description	PCB oven BPG044-104 L 140mm W 80mm for cooler control		
For models:	CCG051M, CCG071M, CCG101M, CCG102M, CKGP06, CKGP06B, CKGP10, CKGP10B, CKGP20, CKGP20B, CKGP21, CKGP21B, CKGP40, CKGP40B, CKGT06, CKGT06B, CKGT10B, CKGT20, CKGT20B, CKGT21, CKGT21B, CKGT40, CKGT40B		



1

GEV No.	402972	Ref. No.	BN011AD1600001
description	relay PCB L 69mm W 59mm		

keypads

control panel



1

GEV No.	697946	Ref. No.	3108550 BN3108550
description	control panel combi-steamer CV6E W 212mm H 725mm D 6mm suitable for OLIS glas		
For models:	CMV6ES2-1320392, CV6E, CV6E-1320000, CV6E-1320050, CV6E-2, CV6E2-1320040, CV6EB-1321000, CV6E-S, CV6E-S2, CV6ES2-1320090, CVM6E, CVM6E-1320300, CVM6E-1320340, CVM6E-1320390, CVM6E-2, CVM6E-S, CVM6ES-1320350, CVM6ES-1320350MN, CVM6ES-1320360, CVM6E-S2, CVM6ES2-1320395, CVM6G, CVM6G-1310300, CVM6G-1310310, CVM6G-2, CVM6G2-1310340, CVM6G-S, CVM6GS-1310350, CVM6GS-1310360, CVM6G-S2, CVM6GS2-1310390, CVM6GS2-1310395, CVP6E, CVP6E-1320600, CVP6E-2, CVP6E2-1320640, CVP6E-S, CVP6ES-1320650, CVP6E-S2, CVP6ES2-1320690, CVP6G, CVP6G-1310600, CVP6G-2, CVP6G2-1310640, CVP6G-S, CVP6GS-1310650, CVP6G-S2, CVP6GS2-1310690, CVP6GS2-1310690MN		

solenoid valves

solenoid valves (water)

ELBI

straight



1

GEV No.	373025	Ref. No.	15099
description	solenoid valve triple straight 230VAC inlet 3/4" outlet 11.5mm DN10 ELBI		
For models:	OLDS37-1081006, OLDS37D-1081007, OLDS37LS-1081008, OLDS37LSD-1081009, OLDS40-1081010, OLDS40D-1081011, OLDS40LS-1081012, OLDS40LSD-1081013, OLElectron400, OLGastro450, OLGs40, OLLinear, OLLP1-S8, OLLP1-S8EL, OLStar		
spare parts for	373025		
	GEV No.	Ref. No.	—
	solenoid valve filter suitable for ELBI		

spare parts and accessories

reducers

outlet side



1

GEV No.	371060	Ref. No.	LA65110520 LAR65110520
description	reducer ELBI flow rate 0.25l/min pressure range 0 up to 10bar tolerance ±15/25% green		

RPE



1

GEV No.	374021	Ref. No.	3103610 BN3103610
description	solenoid valve double straight 230VAC inlet 3/4" outlet 10mm DN10 RPE		
For models:	CVP10E, CVP10E-1320700, CVP10E-1320710, CVP10E-2, CVP10E2-1320740, CVP10E2S-1320790, CVP10E-S, CVP10ES-1320750, CVP10ES-1320760, CVP10E-S2, CVP10G, CVP10G-1310700, CVP10G-1310750, CVP10G-2, CVP10G2-1310740, CVP10GP-1310700, CVP10G-S, CVP10G-S2, CVP10GS2-1310790, CVP20E, CVP20E-1320800, CVP20E-2, CVP20E2-1320840, CVP20E-S, CVP20ES-1320850, CVP20E-S2, CVP20ES2-1320890, CVP20G, CVP20G-1310800, CVP20G-1310850, CVP20G-2, CVP20G-S, CVP20GS-1310840, CVP20G-S2, CVP20GS2-1310890, CVP21E, CVP21E-1322700, CVP21E-2, CVP21E-S, CVP21ES-1322750, CVP21E-S2, CVP21ES2-1322790, CVP21G, CVP21G-1312700, CVP21G-2, CVP21G2-1312740, CVP21G-S, CVP21GS-1312750, CVP21G-S2, CVP21GS2-1312790...(Other models you can see in the webshop)		



			
1			
GEV No.	374017	Ref. No.	10703 3103620 BN3103620
description	solenoid valve single straight 230VAC inlet 3/4" outlet 10mm input 6l/min DN10 RPE polyamide flow regulating valve inlet white membranes NBR pressure range 0.2-10bar		
For models:	CMV6ES2-1320392, CV10E, CV10E-1320100, CV10E-1320110, CV10E-2, CV10E2-1320140, CV10EB-1321100, CV10E-S, CV10ES-1320150, CV10E-S2, CV10ES2-1320190, CV10G, CV10G-1310100, CV10G-2, CV10G2-1310140, CV10GB-1311100, CV10G-S, CV10GS-1310150, CV10G-S2, CV10GS2-1310190, CV20E, CV20E-1320200, CV20E-2, CV20E2-1320240, CV20EB-1321200, CV20E-S, CV20ES-1320250, CV20E-S2, CV20ES2-1320290, CV20G, CV20G-1310200, CV20G-2, CV20G2-1310240, CV20GB-1311200, CV20G-S, CV20GS-1310250, CV20G-S2, CV20GS2-1310290, CV21E, CV21E-1322100, CV21E-2, CV21E2-1322140, CV21E-S, CV21ES-1322150, CV21E-S2, CV21ES2-1322190, CV21G, CV21G-1312100, CV21G-2, CV21G2-1312140...(Other models you can see in the webshop)		

JOHN GUEST			
			
1			
GEV No.	374032 ¹	Ref. No.	R65110230
description	solenoid valve double straight 230VAC inlet 3/4" outlet 10mm DN10 plastic output A w/t membrane (constantly open)		
For models:	CKEP06, CKEP10, CKEP20, CKET06, CKET10, CKET20B, CKGP06, CKGP10, CKGP20, CKGT06, CKGT20, CKGT20B		

¹cylindrical outlet

			
1			
GEV No.	370768 ¹	Ref. No.	LA65110200 LAR65110200
description	solenoid valve single straight 230VAC inlet 3/4" outlet 10mm input/ min output/ min DN10 t.max. 90°C duty cycle 100% RPE		
For models:	CCE042M, CCE051M, CCE071M, CCE101M, CCE102M, CCG051M, CCG071M, CCG101M, CCG102M, CKEP06, CKEP06B, CKEP10, CKEP10B, CKEP20, CKEP20B, CKEP21, CKEP21B, CKEP40, CKEP40B, CKET06, CKET10, CKET10B, CKET21, CKET21B, CKET40, CKET40B, CKGP06, CKGP06B, CKGP10, CKGP10B, CKGP20, CKGP20B, CKGP21, CKGP21B, CKGP40, CKGP40B, CKGT06, CKGT10B, CKGT21, CKGT21B, CKGT40, CKGT40B		

¹cylindrical outlet

reducers			
outlet side			
			
1			
GEV No.	371269	Ref. No.	LA65110500 LAR65110500
description	reducer flow rate 0.07-0.14l/min brown		
For models:	CCE042M, CCE051M, CCE071M, CCG051M, CCG071M, CKEP06, CKEP06B, CKEP40, CKEP40B, CKET06, CKET06B, CKET40, CKET40B, CKGP06, CKGP06B, CKGP40, CKGP40B, CKGT06, CKGT06B, CKGT40, CKGT40B		













solenoid valves with reducers			
2-fold			
			
1			
GEV No.	374031	Ref. No.	R65110210
description	solenoid valve double straight 230VAC inlet 3/4" outlet JG 10 input 10-12l/min t.max. 90°C RPE plastic flow regulating valve inlet white + outlet reducer red		
For models:	CKEP06, CKEP06B, CKEP10, CKEP10B, CKEP20, CKEP20B, CKEP21, CKEP21B, CKET06, CKET06B, CKET10, CKET10B, CKET20, CKET20B, CKET21B, CKGP06, CKGP06B, CKGP10, CKGP10B, CKGP20, CKGP20B, CKGT06, CKGT06B, CKGT10, CKGT10B, CKGT20, CKGT20B		

3-fold			
			
1			
GEV No.	374014 ¹	Ref. No.	LAR65110280
description	solenoid valve triple straight 230VAC inlet 3/4" outlet 10mm input 10-12l/min RPE plastic flow regulating valve inlet white flow regulating valve outlet A red/ green flow regulating valve outlet B red/ green flow regulating valve outlet C red/ green		
For models:	CKEP21, CKEP21B, CKEP40, CKEP40B, CKET21, CKET21B, CKET40, CKET40B, CKGP21, CKGP21B, CKGP40, CKGP40B, CKGT21, CKGT21B, CKGT40, CKGT40B		

¹cylindrical outlet

			
1			
GEV No.	374033	Ref. No.	LAR65110240
description	solenoid valve triple straight 230VAC inlet 3/4" outlet 10mm input 10-12l/min t.max. 90°C RPE plastic flow regulating valve inlet white output B w/t membrane (constantly open)		
For models:	CKEP40, CKET21, CKET40, CKGP21, CKGT21		



TP			
			
1			
GEV No.	370021	Ref. No.	15098
description	solenoid valve double straight 230VAC inlet 3/4" outlet 11.5mm DN10 TP flow regulating valve inlet white		
For models:	OLDerby, OLDS35, OLDS35-1081005, OLDS35-1081061, OLDS35D-1081062, OLDS35-Neutra, OLDS37, OLDS37-1081006, OLDS37-1081063, OLDS37D-1081007, OLDS37D-1081064, OLDS37LS-1081008, OLDS37LSD-1081009, OLDS37-Neutra, OLDS40, OLDS40-1081010, OLDS40-1081065, OLDS40D-1081011, OLDS40D-1081066, OLDS40E-1081067, OLDS40ED-1081068, OLDS40LS-1081012, OLDS40LSD-1081013, OLDS40-Neutra, OLDS45, OLDS50, OLDS50-1081088, OLDS50D-1081089, OLDS50E-1081090, OLDS50ED-1081091, OLDS50-Neutra, OLDS50P-1081018, OLDS50PD-1081019, OLDS50D-1081089, OLElectron1000, OLElectron400, OLElectron500, OLELELECTRON1000-1081084, OLELELECTRON1000D-1081085, OLG35, OLG35-1080702, OLG35D-1081000, OLG35-Neutra, OLG600, OLGastro450, OLGastro500Plus, OLGastro500S, OLGastro750Plus, OLGastro750S, OLGastro750S... (Other models you can see in the webshop)		
spare parts for	370021		
		GEV No.	371013
	solenoid coil TP 230VAC 50/60Hz	Ref. No.	—
accessories for	370021		
		GEV No.	371220
	reducer TP flow rate 3l/min red tolerance ±15%	Ref. No.	—
		GEV No.	371221
	reducer TP flow rate 5.5l/min yellow tolerance ±15%	Ref. No.	—
		GEV No.	371222
	reducer TP flow rate 6l/min grey tolerance ±15%	Ref. No.	—
		GEV No.	371223
	reducer TP flow rate 10l/min white tolerance ±15%	Ref. No.	—
		GEV No.	371224
	reducer TP flow rate 12l/min bronze tolerance ±15%	Ref. No.	—
		GEV No.	371225
	reducer TP flow rate 16l/min light brown tolerance ±15%	Ref. No.	—
		GEV No.	371226
	reducer TP flow rate 20l/min red tolerance ±15%	Ref. No.	—
		GEV No.	371230
	reducer TP flow rate 0.25l/min red tolerance ±25%	Ref. No.	—
		GEV No.	371231
	reducer TP flow rate 0.35l/min violet tolerance ±25%	Ref. No.	—
		GEV No.	371232
	reducer TP flow rate 0.5l/min orange tolerance ±25%	Ref. No.	—
		GEV No.	371233
	reducer TP flow rate 0.8l/min white tolerance ±25%	Ref. No.	—

accessories for 370021			
		GEV No.	371234
	reducer TP flow rate 1l/min light blue tolerance ±25%	Ref. No.	—
		GEV No.	371235
	reducer TP flow rate 1.2l/min brown tolerance ±25%	Ref. No.	—
		GEV No.	371236
	reducer TP flow rate 1.5l/min light brown tolerance ±25%	Ref. No.	—
		GEV No.	371237
	reducer TP flow rate 2.5l/min yellow tolerance ±25%	Ref. No.	—
		GEV No.	371238
	reducer TP flow rate 3.4l/min dark green tolerance ±25%	Ref. No.	15115
		GEV No.	371239
	reducer TP flow rate 5l/min black tolerance ±25%	Ref. No.	—
		GEV No.	371240
	reducer TP flow rate 8l/min blue tolerance ±20%	Ref. No.	—

metal			
ASCO			
spare parts and accessories			
power sockets			
			
1			
GEV No.	371093	Ref. No.	BN3103660
description	power socket plug type compact cable length 1100mm small		

ball valves electric

			
1			
GEV No.	403042	Ref. No.	R65110560
description	ball valve inlet 3/4" IT outlet 3/4" IT 230V L 68mm closed off-current mode of operation electric connection cable 400mm		
For models:	CKEP06B, CKEP10B, CKEP20B, CKEP21B, CKEP40B, CKET06B, CKET10B, CKET20B, CKET21B, CKET40B, CKGP06B, CKGP10B, CKGP20B, CKGP21B, CKGT06B, CKGT10B, CKGT20B, CKGT21B, CKGT40B		

1

GEV No.	401190	Ref. No.	3103590 3198150 BN3103590 BN3198150
description	ball valve inlet 3/4" IT outlet 3/4" IT IP42 230V L 68mm 50/60Hz closed off-current mode of operation electric connection cable 300mm 3.5W duty cycle 50%		
For models:	CVP10E, CVP10E-1320700, CVP10E-1320710, CVP10E-2, CVP10E2-1320740, CVP10E2S-1320790, CVP10E-S, CVP10ES-1320750, CVP10ES-1320760, CVP10E-S2, CVP10G, CVP10G-1310700, CVP10G-1310750, CVP10G-2, CVP10G2-1310740, CVP10G-S, CVP10G-S2, CVP10GS2-1310790, CVP20E, CVP20E-1320800, CVP20E-2, CVP20E2-1320840, CVP20E-S, CVP20ES-1320850, CVP20E-S2, CVP20ES2-1320890, CVP20G, CVP20G-1310800, CVP20G-1310850, CVP20G-2, CVP20G-S, CVP20GS-1310840, CVP20G-S2, CVP20GS2-1310890, CVP21E, CVP21E-1322700, CVP21E-2, CVP21E-S, CVP21ES-1322750, CVP21E-S2, CVP21ES2-1322790, CVP21G, CVP21G-1312700, CVP21G-2, CVP21G2-1312740, CVP21G-S, CVP21GS-1312750, CVP21G-S2, CVP21GS2-1312790, CVP6E...(Other models you can see in the webshop)		

for steam control



1

GEV No.	541074	Ref. No.	3103630 6A03630 BN3103630 LAR63070050
description	pressure control ø 45mm triggering pressure 0.5bar reset pressure 0.35bar pressure connection vertical steam control pressure range 0.35/0.51bar connection 1/8" pressure connection 1/8"		
For models:	CKEP06, CKEP10, CKEP20, CKEP21, CKEP40, CKET06, CKET10, CKET20, CKET21, CKET40, CKGP06, CKGP10, CKGP20, CKGP21, CKGP40, CKGT06, CKGT10, CKGT20, CKGT21, CKGT40, CM-V6ES2-1320392, CVM10E, CVM10E-1320400, CVM10E-1320410, CVM10E-2, CVM10E2-1320440, CVM10E-S, CVM10ES-1320450, CVM10E-S2, CVM10ES2-1320490, CVM10E2S-1320495, CVM10G, CVM10G-1310400, CVM10G-1310410, CVM10G-1310430, CVM10G-1310450, CVM10G-2, CVM10G2-1310440, CVM10GP-1310400, CVM10G-S, CVM10GS-1310460, CVM10G-S2, CVM10GS2-1310490, CVM10GS2-1310495, CVM20E, CVM20E-1320500, CVM20E-2, CVM20E2-1320540, CVM20E-S, CVM20ES-1320550...(Other models you can see in the webshop)		

pressure switches

for gas equipment



1

GEV No.	541073	Ref. No.	LA63070010 LAR63070010
description	pressure control ø 45mm pressure range adjustable 5-20mbar pressure connection vertical gas technology connection 1/4" pressure connection ø 1/4"mm		
For models:	CCG051M, CCG071M, CCG101M, CCG102M, CKGP06, CKGP06B, CKGP10, CKGP10B, CKGP20, CKGP20B, CKGP21, CKGP21B, CKGP40, CKGP40B, CKGT06, CKGT06B, CKGT10, CKGT10B, CKGT20, CKGT20B, CKGT21, CKGT21B, CKGT40, CKGT40B		

electrodes



1

GEV No.	401208	Ref. No.	6A037482 BN6A037482
description	level electrode 1/4" total length 150mm probe L 124mm insulated probe length 69mm PTFE insulated connection male faston 6.3mm stainless steel ø 2.5mm		
For models:	CVP10E, CVP10E-1320700, CVP10E-2, CVP10E2-1320740, CVP10E2S-1320790, CVP10E-S, CVP10ES-1320750, CVP10E-S2, CVP10G, CVP10G-1310700, CVP10G-1310750, CVP10G-2, CVP10G2-1310740, CVP10GP-1310700, CVP10G-S, CVP10G-S2, CVP10GS2-1310790, CVP20E, CVP20E-1320800, CVP20E-2, CVP20E2-1320840, CVP20E-S, CVP20ES-1320850, CVP20E-S2, CVP20ES2-1320890, CVP20G, CVP20G-1310800, CVP20G-1310850, CVP20G-2, CVP20G-S, CVP20GS-1310840, CVP20G-S2, CVP20GS2-1310890, CVP21E, CVP21E-1322700, CVP21E-2, CVP21E-S, CVP21ES-1322750, CVP21E-S2, CVP21ES2-1322790, CVP21G, CVP21G-1312700, CVP21G-2, CVP21G2-1312740, CVP21G-S, CVP21GS-1312750, CVP21G-S2, CVP21GS2-1312790, CVP6E, CVP6E-1320600...(Other models you can see in the webshop)		



GEV No.	401209	Ref. No.	6A037481 BN6A037481
description	level electrode 1/4" total length 180mm probe L 155mm insulated probe length 70mm PTFE insulated connection male faston 6.3mm stainless steel ø 2.5mm		
For models:	CVP10E, CVP10E-1320700, CVP10E-2, CVP10E2-1320740, CVP10E2S-1320790, CVP10E-S, CVP10ES-1320750, CVP10E-S2, CVP10G, CVP10G-1310700, CVP10G-1310750, CVP10G-2, CVP10G2-1310740, CVP10GP-1310700, CVP10G-S, CVP10G-S2, CVP10GS2-1310790, CVP20E, CVP20E-1320800, CVP20E-2, CVP20E2-1320840, CVP20E-S, CVP20ES-1320850, CVP20E-S2, CVP20ES2-1320890, CVP20G, CVP20G-1310800, CVP20G-1310850, CVP20G-2, CVP20G-S, CVP20GS-1310840, CVP20G-S2, CVP20GS2-1310890, CVP21E, CVP21E-1322700, CVP21E-2, CVP21E-S, CVP21ES-1322750, CVP21E-S2, CVP21ES2-1322790, CVP21G, CVP21G-1312700, CVP21G-2, CVP21G2-1312740, CVP21G-S, CVP21GS-1312750, CVP21G-S2, CVP21GS2-1312790, CVP6E, CVP6E-1320600...(Other models you can see in the webshop)		

GEV No.	400130	Ref. No.	R65320010
description	level electrode M14x1.25 total length 220mm probe L 194mm insulated probe length 26mm connection male faston 6.3mm ø 2.5mm		
For models:	CKEP06B, CKEP10B, CKEP20B, CKEP21B, CKEP40B, CKET06B, CKET10B, CKET20B, CKET21B, CKET40B, CKGP06B, CKGP10B, CKGP20B, CKGP21B, CKGP40B, CKGT06B, CKGT10B, CKGT20B, CKGT21B, CKGT40B		

fans

axial fans

ebm-papst





GEV No.	601030 ¹	Ref. No.	3102350 65060050 BN3102350 LA65060050 LAR65060050
description	axial fan L 119mm W 119mm H 38mm 230VAC 50Hz 18W bearing ball bearing manuf. no. 4656Z metal connection male faston 2.8mm ebm-papst fan wheel ø 110mm temp.-resist. 75°C		
For models:	7PCV-WOK400, 92-04VTCI-12901035, 92-04VTCIWOK, CCE071M, CCE101M, CCE102M, CCG071M, CCG101M, CCG102M, CKEP06, CKEP06B, CKEP10, CKEP10B, CKEP20, CKEP20B, CKEP21, CKEP21B, CKEP40, CKEP40B, CKET06, CKET06B, CKET10, CKET10B, CKET20, CKET20B, CKET21, CKET21B, CKET40, CKET40B, CKGP06, CKGP06B, CKGP10, CKGP10B, CKGP20, CKGP20B, CKGP21, CKGP21B, CKGP40, CKGP40B, CKGT06, CKGT06B, CKGT10B, CKGT20, CKGT20B, CKGT21, CKGT21B, CKGT40, CKGT40B, CMV6ES2-1320392, CV10E...(Other models you can see in the webshop)		
accessories for	601030		
	GEV No.	550898	Ref. No. —
	connecting cable cable length 2000mm connection F 2.8 connection distance 7.9mm for axial flow fan		
	GEV No.	692497	Ref. No. —
	guard ø 105mm mounting distance 150mm for axial fan ebm-papst-mm		

¹with ball bearings

import



GEV No.	601080 ¹	Ref. No.	1648110107
description	axial fan L 119mm W 119mm H 38mm 230VAC 50/60Hz 23/20W bearing ball bearing connection male faston 2.8mm metal ADDA fan wheel ø 110mm temp.-resist. 70°C		
For models:	KBT40-21091640, KC41-210916400BDC, KR41-210906400BFA, KTAPO2BT-BASE-2022630105KW, KTN40-21090640, KTRPBT300222-2022630107KT, KTRPBT300222A-2022630107KU, ROLL-IN1P-211008120CJE, ROLL-IN1P-211008120CJG, ROLL-IN1PBT-211009120CJF, ROLL-IN2P-211016120CJL, ROLL-IN2P-211016120CJM, ROLL-IN2P-211016220CJN, ROLL-IN2P-211016220CJP, ROLL-IN-2PMTN-211016220CJO, ROLL-INP1P-211008220CJH, ROLL-IN-P1P-211008220CJK, ROLL-INP1PBT-211009220CJI, ROLL-INP1PP-MTN-211008220CJJ		
accessories for	601080		
	GEV No.	550898	Ref. No. —
	connecting cable cable length 2000mm connection F 2.8 connection distance 7.9mm for axial flow fan		
	GEV No.	692519	Ref. No. —
	guard L 120mm W 120mm plastic		



¹with ball bearings



GEV No.	601081 ¹	Ref. No.	R65060010
description	axial fan L 80mm W 80mm H 38mm 230VAC 50/60Hz 14/13.5W bearing ball bearing connection male faston 2.8mm metal ADDA fan wheel ø 75mm temp.-resist. 70°C		
For models:	CCG051M		
accessories for	601081		
	GEV No.	691102	Ref. No. —
	guard ø 75mm mounting distance 71mm for axial fan 80mm		

¹with ball bearings



GEV No.	601055 ¹	Ref. No.	1648110150 6A036420 BN6A036420
description	axial fan L 92mm W 92mm H 25mm 230VAC 50/60Hz 14.5/14W bearing ball bearing connection male faston 2.8mm metal ADDA fan wheel ø 85mm temp.-resist. 70°C		
For models:	72-02TVTCV, 72-02TVTCV-12731005, 72-02VTC, 72-02VTCV, 72-02VTG-12701005, 74-02TVTCV, 74-02TVTCV-12731006, 74-02VTCV, 74-02VTCV-12701020, 74-02VTCV, 74-02VTCV-12701006, 7NPCF-VCE800, 7NPC-VCE400, 7NPC-VCE800, 7NPCVP-VCE400, 7NPCVP-VCE800, 7NPCV-VCE400, 7NPCV-VCE800, 92-04VTVC, 92-04VTVC-12931005, 92-04VTVCV-12931055, 92-04VTC, 92-04VTCV-12901055, 94-04VTVC, 94-04VTVC-12931006, 94-04VTVCV-12931056, 94-04VTC, 94-04VTCV, 94-04VTCV-12901050, 94-04VTCV-12901056, 9NPCF-VCE800, 9NPC-VCE400, 9NPC-VCE800, 9NPCVP-VCE400, 9NPCVP-VCE800, 9NPCV-VCE400, 9NPCV-VCE800, KTRE21-202108010BL5, KTRE2-202108010BFC, KTRE2A-202108010BGP, KTRE3-202113010BHF, KTRE32A-202113010BLQ, KTRE34-202113010BLW, KTRE3A-202113010BFW, KTRE4-202117010BLG, KTRE42-202117010BM0, KTRE42A-202117010BM6, KTRE44-202117010BMB, KTRE4A-202117010BFF, KTRE5-202122010BG2...(Other models you can see in the webshop)		
accessories for	601055		
	GEV No.	550898	Ref. No. —
	connecting cable cable length 2000mm connection F 2.8 connection distance 7.9mm for axial flow fan		
	GEV No.	691103	Ref. No. —
	guard ø 90mm mounting distance 83mm for axial fan 92mm		

¹with ball bearings



hot air motors



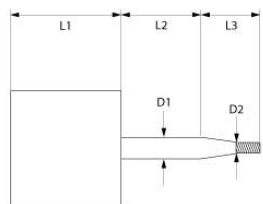

GEV No.	550857	Ref. No.	LA58003870 LAR58003870
description	counterflange for fan motor ED ø 50mm int. ø 1 25mm int. ø 2 16mm thickness 6mm brass		
For models:	CCE071M, CCG071M, CKEP06, CKEP06B, CKET06, CKET06B, CKGP06, CKGP06B, CKGT06, CKGT06B		

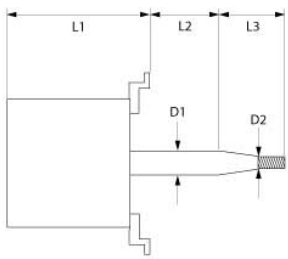
			
GEV No.	550859	Ref. No.	LA58003850 LAR58003850
description	counterflange for fan motor ED ø 60mm int. ø 1 34mm int. ø 2 25mm thickness 6mm brass		
For models:	CCE101M, CCE102M, CCG101M, CCG102M, CKEP10, CKEP10B, CKEP20, CKEP20B, CKEP21, CKEP21B, CKEP40, CKEP40B, CKET10, CKET10B, CKET20, CKET20B, CKET21, CKET21B, CKET40, CKET40B, CKGP10, CKGP10B, CKGP20, CKGP20B, CKGP21, CKGP21B, CKGP40, CKGP40B, CKGT10B, CKGT20, CKGT20B, CKGT21, CKGT21B, CKGT40, CKGT40B		

 			
GEV No.	500661	Ref. No.	R65040431
description	fan motor 220-240V 1 phase 50Hz 0.03/0.2kW 0.05/0.25HP 1400/2700rpm speeds 2 L1 123mm L2 77mm L3 30mm D1 ø 15mm D2 ø 12mm M10L ET 1.6/0.6A suitable capacitor 10µF/450 V at 50Hz 1400/2700rpm type 1057D1901		
For models:	CKEP06, CKEP06B, CKGP06, CKGP06B		

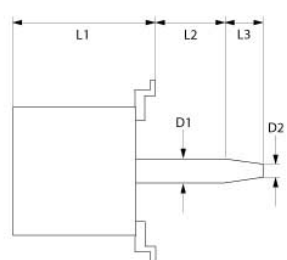

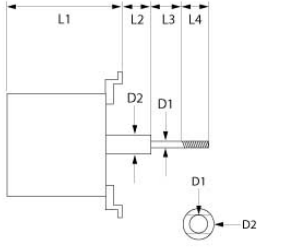

 			
GEV No.	500656	Ref. No.	LAR65040520
description	fan motor 200-240/415V 3 phase 50/60Hz 0.15/0.55kW 900/1400rpm speeds 2 L1 150mm L2 50mm L3 48mm D1 ø 24mm D2 ø 20mm M12L IT 2.3/1.3-1.2/0.7A at 50Hz 200-240/415V at 60Hz 200-240/480V at 50Hz 900/1400rpm at 60Hz 1100/1700rpm type 3042D4050		
For models:	CKEP10, CKEP10B, CKEP20, CKEP20B, CKEP21, CKEP21B, CKEP40, CKEP40B		
spare parts for	500656		
			
GEV No.	511172	Ref. No.	LA70020050 LAR70020050 R70020050
shaft sealing ID ø 24mm ED ø 29mm thickness 3mm			

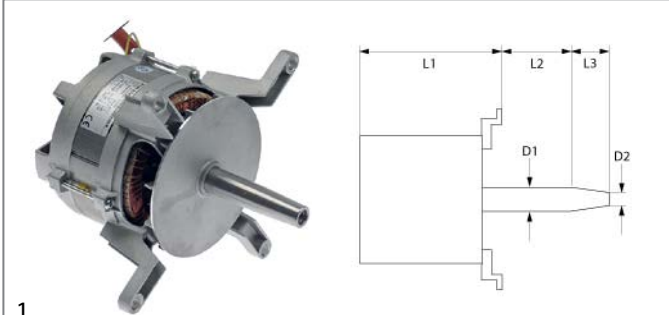
 			
GEV No.	500644	Ref. No.	3102300 BN3102300
description	fan motor 230/400V 3 phase 50/60Hz 0.55kW 0.58HP 1420/1700rpm speeds 1 L1 188mm L2 67mm L3 46mm D1 ø 24mm D2 ø 20mm M12L IT 1.1/1.9A Cos(φ) 0.6 at 50Hz 1420/1700rpm type ST80/4 no. 654282 mounting distance 185mm		
For models:	CV10E, CV10E-1320100, CV10E-1320110, CV10EB-1321100, CV10E-S, CV10ES-1320150, CV10G, CV10G-1310100, CV10G-S, CV10GS-1310150, CV20E, CV20E-1320200, CV20EB-1321200, CV20E-S, CV20ES-1320250, CV20G, CV20G-1310200, CV20G-S, CV20GS-1310250, CV21E, CV21E-1322100, CV21E-S, CV21ES-1322150, CV6E, CV6E-1320000, CV6E-1320010, CV6E-1320050, CV6EB-1321000, CV6E-S, CV6G, CV6G-1310000, CV6G-S, CV6GS-1310050, CVM10E, CVM10E-1320400, CVM10E-1320410, CVM10E-S, CVM10ES-1320450, CVM10G, CVM10G-1310400, CVM10G-1310430, CVM10G-1310450, CVM10G-S, CVM20E, CVM20E-1320500, CVM20E-S, CVM20ES-1320550, CVM20G, CVM20G-1310500, CVM20G-S...(Other models you can see in the webshop)		
accessories for	500644		
			
GEV No.	560449	Ref. No.	3102250 BN3102250 LA58004000 LAR58004000 R58004000
hexagonal screw thread M12x1.5 L thread L 22mm bore ø 6.3mm WS 19 total length 30mm			

 			
GEV No.	500662	Ref. No.	R65041000
description	fan motor 220-240V 1 phase 50/60Hz 0.12kW 2800/3200rpm speeds 1 L1 85mm L2 7mm L3 47mm L4 12mm D1 ø 8/6mm D2 ø 12mm M5R ET 1.6A power input 0.25W suitable capacitor 5µF/400V		
For models:	CCE042M, CCE051M, CCG051M		



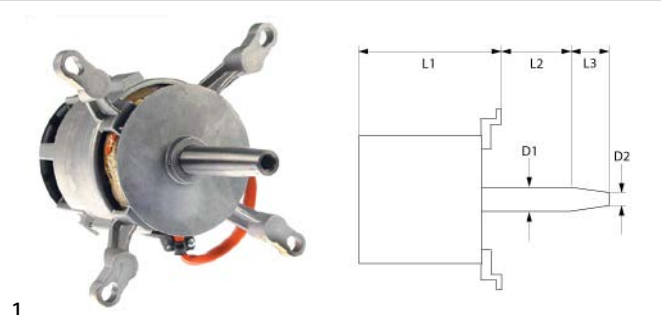

1

GEV No.	500658	Ref. No.	LAR65040530
description	fan motor 230/400V 3 phase 50/60Hz 0.55kW 1400/1700rpm speeds 1 L1 145mm L2 47mm L3 47mm D1 ø 24mm D2 ø 20mm M12L IT 2.6-2.3/1.5-1.3A (at 50-60Hz)A Cos(fi) 0.73 at 50Hz 200-240/415V at 60Hz 200-240/480V at 50Hz 1400rpm at 60Hz 1700rpm		
For models:	CCE101M, CCE102M, CKEP10, CKEP10B, CKEP20, CKEP20B, CKEP21, CKEP21B, CKEP40, CKEP40B, CKET10, CKET10B, CKET20, CKET20B, CKET21, CKET21B, CKET40, CKET40B, CKGT10B, CKGT20, CKGT20B, CKGT21, CKGT21B, CKGT40, CKGT40B		
spare parts for	500658		
	GEV No.	511172	Ref. No. LA70020050 LAR70020050 R70020050
	shaft sealing ID ø 24mm ED ø 29mm thickness 3mm		
	GEV No.	551476	Ref. No. —
accessories for	500658		
	GEV No.	560449	Ref. No. 3102250 BN3102250 LA58004000 LAR58004000 R58004000
	hexagonal screw thread M12x1.5 L thread L 22mm bore ø 6.3mm WS 19 total length 30mm		
	GEV No.	601244	Ref. No. LA75400440 LAR75400440 R75400440
	fan wheel D1 ø 350mm H1 114mm blades 12 D2 ø 19.5mm D3 ø 23mm H2 45mm		



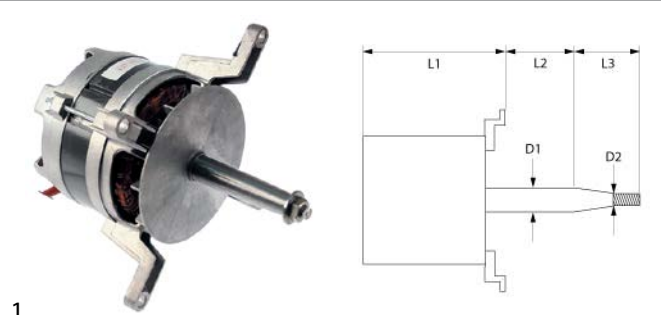

1

GEV No.	500646	Ref. No.	3102200 BN3102200
description	fan motor 230V 1 phase 50/60Hz 0.55kW 1400/1680rpm speeds 1 L1 188mm L2 67mm L3 47mm D1 ø 24mm D2 ø 20mm M12L IT 2.4A suitable capacitor 20µF/450V Cos(fi) 0.95 at 50Hz 1400rpm at 60Hz 1680rpm type LM80/4 no. 601259		
For models:	CV10G, CV10G-1310100, CV10GB-1311100, CV10G-S, CV10GS-1310150, CV20G, CV20G-1310200, CV20GB-1311200, CV20G-S, CV20GS-1310250, CV21G, CV21G-1312100, CV21G-S, CV21GS-1312150, CV6G, CV6G-1310000, CV6G-1310010, CV6GB-1311000, CV6G-S, CV6GS-1310050, CV-M10G-1310400, CVM10G-1310410, CVM10G-1310430, CV-M10G-1310450, CVM10GP-1310400, CVM10GS-1310460, CVM20G-1310500, CVM20GS-1310550, CVM21G, CV-M21G-1312400, CVM21G-S, CVM21GS-1312450, CV-M6G-1310300, CVM6G-1310310, CVM6GS-1310350, CVM-6GS-1310360, FC10G-418035410100, FC10G-S-418035410150, FC20G-418035410200, FC20G-S-418035410250, FC21G-B-418035412100, FC21G-S-418035412150, FC6G-418035410000, FC6G-S-418035410050, FCM10G-418035410400, FCM10G-S-418035410450, FCM10G-S-418035410450AU, FCM20G-418035410500, FCM20G-S-418035410550, FC-M21G-418035412400...(Other models you can see in the webshop)		
accessories for	500646		
	GEV No.	365019	Ref. No. —
	operating capacitor capacity 20µF 400V tolerance 5% 50/60Hz ambient temperature max. -25 to +85°C ø 39.5mm L 70mm M8 plastic connection male faston 6.3mm 16.10.25. protection		
	GEV No.	560449	Ref. No. 3102250 BN3102250 LA58004000 LAR58004000 R58004000
	hexagonal screw thread M12x1.5 L thread L 22mm bore ø 6.3mm WS 19 total length 30mm		



1

GEV No.	500659	Ref. No.	LAR65040550
description	fan motor 230V 1 phase 50/60Hz 0.55kW 1400/1700rpm speeds 1 L1 150mm L2 52mm L3 45mm D1 ø 24mm D2 ø 20mm M12L IT 3A suitable capacitor 20µF/450V Cos(fi) 0.9 at 50Hz 1400rpm at 60Hz 1700rpm type 3042A2350		
For models:	CCG101M, CCG102M, CKGP10, CKGP10B, CKGP20, CKGP20B, CKGP21, CKGP21B, CKGP40, CKGP40B		
spare parts for	500659		
	GEV No.	511172	Ref. No. LA70020050 LAR70020050 R70020050
	shaft sealing ID ø 24mm ED ø 29mm thickness 3mm		

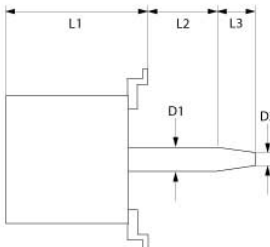

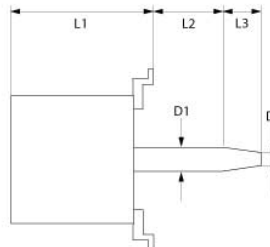

1

GEV No.	500647	Ref. No.	3102210 BN3102210
description	fan motor 230V 1 phase 50Hz 0.13/0.55kW 700/1400rpm speeds 2 L1 188mm L2 64mm L3 46mm D1 ø 24mm D2 ø 20mm 0.66/2.4A suitable capacitor 25µF Cos(fi) 0.98 at 50Hz 700/1400rpm at 60Hz 850/1700rpm 4P/8P type LM/FB80 no. 483823		
For models:	CMV6ES2-1320392, CV10G-2, CV10G2-1310140, CV10G-S2, CV10GS2-1310190, CV20G-2, CV20G2-1310240, CV20G-S2, CV20GS2-1310290, CV21G-2, CV21G2-1312140, CV21G-S2, CV21GS2-1312190, CV6G-2, CV6G2-1310040, CV6G-S2, CV6GS2-1310090, CVM10G2-1310440, CVM10GS2-1310490, CVM20G2-1310540, CVM20GS2-1310590, CVM21G-2, CVM21G2-1312440, CVM21G-S2, CVM21GS2-1312490, CVM6G2-1310340, CVM6GS2-1310390, FC10G-2-418035410140, FC10G-2S-418035410190, FC20G-2-418035410240, FC20G-2S-418035410290, FC21G-2-418035412140, FC21G-2S-418035412190, FC6G-2-418035410040, FC6G-2S-418035410090, FCM10G-2-418035410440, FCM10G-2S-418035410490, FCM20G-2-418035410540, FCM20G-2S-418035410590, FCM21G-2-418035412440, FCM21G-2S-418035412490, FCM6G-2-418035410340, FCM6G-2S-418035410390		

1

GEV No.	500657	Ref. No.	R65040540
description	fan motor 230V 1 phase 50Hz 0.15/0.55kW 900/1400rpm speeds 2 L1 150mm L2 45mm L3 47mm D1 ø 24mm D2 ø 20mm M12L IT 1.3/3.0A suitable capacitor 20/10µF Cos(fi) 0.98 at 50Hz 900/1400rpm at 60Hz 1100/1700rpm 4P/6P type LM/FB 100L no. 472986		
For models:	CKGP10, CKGP10B, CKGP20, CKGP20B, CKGP21, CKGP21B, CKGP40, CKGP40B		
spare parts for	500657		
	GEV No.	511172	Ref. No. LA70020050 LAR70020050 R70020050
shaft sealing ID ø 24mm ED ø 29mm thickness 3mm			

1

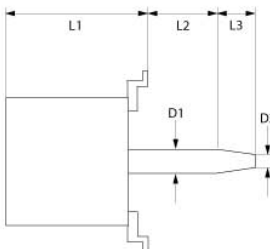
GEV No.	500649	Ref. No.	3102212 BN3102212
description	fan motor 230V 1 phase 50Hz 0.13/0.55kW 700/1400rpm speeds 2 L1 200mm L2 67mm L3 47mm D1 ø 24mm D2 ø 20mm M12L IT 0.66/2.4A suitable capacitor 8/25 µF Cos(fi) 0.98 at 50Hz 700/1400rpm at 60Hz 850/1700rpm 4P/8P type LM/FB80 no. 635521		
For models:	ECVM10ES2, ECVM10ES2-1324290, ECVM10ES2-1326120, ECVM10GS2, ECVM10GS2-1314290, ECVM10GS2-1316120, ECVM20ES2, ECVM20ES2-1324390, ECVM20ES2-1326140, ECVM20GS2, ECVM20GS2-1314390, ECVM20GS2-1316140, ECVM21ES2, ECVM21GS2, ECVM21GS2-1314490, ECVM21GS2-1316160, ECVM6ES2, ECVM6ES2-1324190, ECVM6ES2-1326100, ECVM6ES2-1326100H, ECVM6GS2, ECVM6GS2-1314190, ECVM6GS2-1316100, ECVP10ES2, ECVP10ES2-1324690, ECVP10ES2-1326200, ECVP20ES2, ECVP20ES2-1324790, ECVP20ES2-1326220, ECVP21ES2, ECVP21ES2-1324890, ECVP21ES2-1326240, ECVP6ES2, ECVP6ES2-1324590, ECVP6ES2-1326180, NECVM10ES2, NECVM10ES2-1327290, NECVM10ES2-1328120, NECVM10ES2-1328120H, NECVM10GS2, NECVM10GS2-1317290, NECVM10GS2-1318120, NECVM20ES2, NECVM20ES2-1327390, NECVM20ES2-1328140, NECVM20GS2, NECVM20GS2-1317390, NECVM20GS2-1318140, NECVM21ES2, NECVM21ES2-1327490...(Other models you can see in the webshop)		



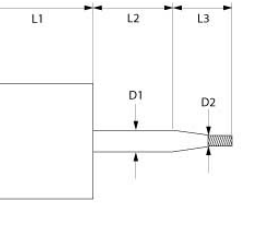

1

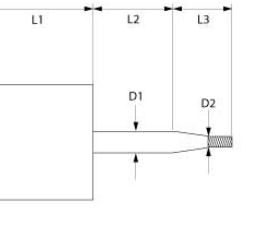
GEV No.	500663	Ref. No.	R65040421
description	fan motor 230V 1 phase 50Hz 0.18kW 0.25HP 2800rpm speeds 1 L1 123mm L2 77mm L3 30mm D1 ø 15mm D2 ø 12mm M10L ET 1.6A suitable capacitor 10µF/400V Cos(fi) 0.95 at 50Hz 2800rpm type 1057C2401		
For models:	CCE071M, CCG071M, CKEP06, CKEP06B, CKGP06, CKGP06B		





1

GEV No.	500680	Ref. No.	LAR65040420
description	fan motor 230V 1 phase 50Hz 0.37kW 2800rpm speeds 1 L1 121mm L2 77mm L3 31mm D1 ø 16mm D2 ø 11mm 2.5A Cos(fi) 0.95 at 50Hz 230V at 50Hz 2800rpm type 1057.2155		
accessories for	500680		
	GEV No.	601060	Ref. No. —
fan wheel D1 ø 180mm H1 60mm blades 16 D2 ø 11mm D3 ø 16mm H2 30mm			



GEV No.	501566	Ref. No.	LAR65040600
description	fan motor 230V 3 phase 50Hz 0.25kW 2700rpm L1 122mm L2 77mm L3 30mm D1 ø 15mm D2 ø 8mm M10 1.5A type FIR no. 1057.2650		
For models:	CKET06, CKET06B, CKGT06, CKGT06B		



GEV No.	500645	Ref. No.	3102310 BN3102310
description	fan motor 400V 3 phase 50Hz 0.13/0.55kW 720/1440rpm speeds 2 L1 188mm L2 64mm L3 46mm D1 ø 24mm D2 ø 20mm 0.4/0.85A Cos(fi) 0.60/0.75 at 50Hz 720/1440rpm at 60Hz 860/1720rpm type FB80 4/8 no. 520481		
For models:	CV10E-2, CV10E2-1320140, CV10E-S2, CV10ES2-1320190, CV10G, CV10G-2, CV10G2-1310140, CV10G-S, CV10G-S2, CV10GS2-1310190, CV20E-2, CV20E2-1320240, CV20E-S2, CV20ES2-1320290, CV20G, CV20G-2, CV20G2-1310240, CV20G-S, CV20G-S2, CV20GS2-1310290, CV21E-2, CV21E2-1322140, CV21E-S2, CV21ES2-1322190, CV6E-2, CV6E2-1320040, CV6E-S2, CV6ES2-1320090, CV6G-2, CV6G2-1310040, CV6G-S2, CV6GS2-1310090, CVM10E-2, CVM10E2-1320440, CVM10E-S2, CVM10ES2-1320490, CVM10G-2, CVM10G2-1310440, CVM10G-S2, CVM10GS2-1310490, CVM20E-2, CVM20E2-1320540, CVM20E-S2, CVM20ES2-1320590, CVM20G-2, CVM20G2-1310540, CVM20G-S2, CVM20GS2-1310590, CVM21E-2, CVM21E2-1322440... (Other models you can see in the webshop)		



GEV No.	500648	Ref. No.	3102312 BN3102312
description	fan motor 400V 3 phase 50Hz 0.13/0.55kW 720/1440rpm speeds 2 L1 198mm L2 65mm L3 47mm D1 ø 24mm D2 ø 20mm M12L IT 400 0.4/0.85A Cos(fi) 0.60/0.75 at 50Hz 720/1440rpm at 60Hz 860/1720rpm type FB80 4/8 no. 500256		
For models:	ECVM10ES2, ECVM10ES2-1324290, ECVM10ES2-1326120, ECVM20ES2, ECVM20ES2-1324390, ECVM20ES2-1326140, ECVM21ES2, ECVM6ES2, ECVM6ES2-1324190, ECVM6ES2-1326100, ECVM6ES2-1326100H, ECVP10ES2, ECVP10ES2-1324690, ECVP10ES2-1326200, ECVP10GS2, ECVP10GS2-1314690, ECVP10GS2-1316200, ECVP20ES2, ECVP20ES2-1324790, ECVP20ES2-1326220, ECVP20GS2, ECVP20GS2-1314790, ECVP20GS2-1316220, ECVP21ES2, ECVP21ES2-1324890, ECVP21ES2-1326240, ECVP21GS2, ECVP21GS2-1314890, ECVP21GS2-1316240, ECVP6ES2, ECVP6ES2-1324590, ECVP6ES2-1326180, ECVP6GS2, ECVP6GS2-1314590, ECVP6GS2-1316180, NECVM10ES2, NECVM10ES2-1327290, NECVM10ES2-1328120, NECVM10ES2-1328120H, NECVM20ES2, NECVM20ES2-1327390, NECVM20ES2-1328140, NECVM21ES2, NECVM21ES2-1327490, NECVM21ES2-1328160, NECVM6ES2, NECVM6ES2-1327190, NECVM6ES2-1328100, NECVP10ES2, NECVP10ES2-1327690...(Other models you can see in the webshop)		



GEV No.	602150	Ref. No.	LA75400550
description	fan wheel blades 12 D1 ø 325mm D2 ø 19.5mm D3 ø 23mm H1 130mm H2 42mm H3 87mm		



GEV No.	602148	Ref. No.	LA75400471 LAR75400471 R75400470
description	fan wheel blades 12 D1 ø 350mm D2 ø 19.5mm D3 ø 23mm H1 118mm H2 50mm		
For models:	CKEP10, CKEP10B, CKEP20, CKEP20B, CKEP21, CKEP21B, CKEP40, CKEP40B, CKGP10, CKGP10B, CKGP20, CKGP20B, CKGP21, CKGP21B, CKGP40, CKGP40B		



1

GEV No.	602146	Ref. No.	R75400490
description	fan wheel blades 8 D1 ø 220mm D2 ø 11mm D3 ø 16mm H1 83mm H2 25mm		
For models:	CKEP06, CKEP06B, CKET06, CKET06B		



1

GEV No.	601353	Ref. No.	R75400510
description	fan wheel D1 ø 150mm H1 50mm blades 36 D2 ø 8mm D3 ø 6/8mm H2 26mm		
For models:	CCE042M		



1

GEV No.	601246	Ref. No.	R75400410
description	fan wheel D1 ø 180mm H1 77mm blades 12 D2 ø 8mm D3 ø 6mm H2 25.5mm		
For models:	CCE051M, CCG051M		



1

GEV No.	601243	Ref. No.	R75400400
description	fan wheel D1 ø 220mm H1 78mm blades 12 D2 ø 11mm D3 ø 16mm H2 29mm		
For models:	CCE071M, CCG071M, CKEP06, CKEP06B, CKET06, CKET06B, CKGP06, CKGP06B, CKGT06, CKGT06B		



1

GEV No.	601214	Ref. No.	3101630 BN3101630
description	fan wheel D1 ø 335mm H1 135mm blades 12 D2 ø 19.5mm D3 ø 23.5mm H2 51mm		
For models:	CV20E, CV20E-1320200, CV20E-2, CV20E2-1320240, CV20EB-1321200, CV20E-S, CV20ES-1320250, CV20E-S2, CV20ES2-1320290, CV20G, CV20G-1310200, CV20G-2, CV20G2-1310240, CV20GB-1311200, CV20G-S, CV20GS-1310250, CV20G-S2, CV20GS2-1310290, CVM20E, CVM20E-1320500, CVM20E-2, CVM20E2-1320540, CVM20E-S, CVM20ES-1320550, CVM20E-S2, CVM20ES2-1320590, CVM20G, CVM20G-1310500, CVM20G-2, CVM20G2-1310540, CVM20G-S, CVM20GS-1310550, CVM20G-S2, CVM20GS2-1310590, CVP20E, CVP20E-1320800, CVP20E-2, CVP20E2-1320840, CVP20EB-1321200, CVP20E-S, CVP20ES-1320850, CVP20E-S2, CVP20ES2-1320890, CVP20G, CVP20G-1310800, CVP20G-1310850, CVP20G-2, CVP20G-S, CVP20GS-1310840, CVP20G-S2...(Other models you can see in the webshop)		
accessories for	601214		
	GEV No.	560449	Ref. No.
			3102250 BN3102250 LA58004000 LAR58004000 R58004000
	hexagonal screw thread M12x1.5 L thread L 22mm bore ø 6.3mm W5 19 total length 30mm		



1

GEV No.	601213	Ref. No.	3101600 BN3101600
description	fan wheel D1 ø 335mm H1 135mm blades 16 D2 ø 19.5mm D3 ø 23.5mm H2 50.5mm		
For models:	CMV6ES2-1320392, CV10E, CV10E-1320100, CV10E-1320110, CV10E-2, CV10E2-1320140, CV10EB-1321100, CV10E-S, CV10ES-1320150, CV10E-S2, CV10ES2-1320190, CV10G, CV10G-1310100, CV10G-2, CV10G2-1310140, CV10GB-1311100, CV10G-S, CV10GS-1310150, CV10G-S2, CV10GS2-1310190, CV21E, CV21E-1322100, CV21E-2, CV21E2-1322140, CV21E-S, CV21ES-1322150, CV21E-S2, CV21ES2-1322190, CV21G, CV21G-1312100, CV21G-2, CV21G2-1312140, CV21G-S, CV21GS-1312150, CV21G-S2, CV21GS2-1312190, CV6E, CV6E-1320000, CV6E-1320010, CV6E-1320050, CV6E-2, CV6E2-1320040, CV6EB-1321000, CV6E-S, CV6E-S2, CV6ES2-1320090, CV6G, CV6G-1310000, CV6G-1310010, CV6G-2...(Other models you can see in the webshop)		



1

GEV No.	601244	Ref. No.	LA75400440 LAR75400440
description	fan wheel D1 ø 350mm H1 114mm blades 12 D2 ø 19.5mm D3 ø 23mm H2 45mm		
For models:	CCE101M, CCE102M, CCG101M, CCG102M, CKEP10, CKEP10B, CKEP20, CKEP20B, CKEP21, CKEP21B, CKEP40, CKEP40B, CKET10, CKET10B, CKET20, CKET20B, CKET21, CKET21B, CKET40, CKET40B, CKGP10, CKGP10B, CKGP20, CKGP20B, CKGP21, CKGP21B, CKGP40, CKGP40B, CKGT10B, CKGT20, CKGT20B, CKGT21, CKGT21B, CKGT40, CKGT40B		



1

GEV No.	550856	Ref. No.	LA58003860 LAR58003860
description	flange for fan motor ED ø 50mm int. ø 1 19.5mm int. ø 2 16mm thickness 3mm brass		
For models:	CCE071M, CCG071M, CKEP06, CKEP06B, CKET06, CKET06B, CKGP06, CKGP06B, CKGT06, CKGT06B		



1

GEV No.	550858	Ref. No.	LA58003840 LAR58003840
description	flange for fan motor ED ø 60mm int. ø 1 28.5mm int. ø 2 25mm thickness 4mm brass		
For models:	CCE101M, CCE102M, CCG101M, CCG102M, CKEP10, CKEP10B, CKEP20, CKEP20B, CKEP21, CKEP21B, CKEP40, CKEP40B, CKET10, CKET10B, CKET20, CKET20B, CKET21, CKET21B, CKET40, CKET40B, CKGP10, CKGP10B, CKGP20, CKGP20B, CKGP21, CKGP21B, CKGP40, CKGP40B, CKGT10B, CKGT20, CKGT20B, CKGT21, CKGT21B, CKGT40, CKGT40B		



1

GEV No.	550860	Ref. No.	R58005500
description	flange for gasket ED ø 35mm int. ø 1 22mm int. ø 2 9mm thickness 8mm brass		
For models:	CCE042M, CCE051M, CCG051M		



1

GEV No.	550850	Ref. No.	3102500 BN3102500
description	flange pair for fan motor ED ø 70mm int. ø 1 43.5mm int. ø 2 24.5mm thickness 5mm brass		
For models:	CMV6ES2-1320392, CV10E, CV10E-1320100, CV10E-1320110, CV10E-2, CV10E2-1320140, CV10EB-1321100, CV10E-S, CV10ES-1320150, CV10E-S2, CV10ES2-1320190, CV10G, CV10G-1310100, CV10G-2, CV10G2-1310140, CV10GB-1311100, CV10G-S, CV10GS-1310150, CV10G-S2, CV10GS2-1310190, CV20E, CV20E-1320200, CV20E-2, CV20E2-1320240, CV20EB-1321200, CV20E-S, CV20ES-1320250, CV20E-S2, CV20ES2-1320290, CV20G, CV20G-1310200, CV20G-2, CV20G2-1310240, CV20GB-1311200, CV20G-S, CV20GS-1310250, CV20G-S2, CV20GS2-1310290, CV21E, CV21E-1322100, CV21E-2, CV21E2-1322140, CV21E-S, CV21ES-1322150, CV21E-S2, CV21ES2-1322190, CV21G, CV21G-1312100, CV21G-2, CV21G2-1312140...(Other models you can see in the webshop)		



1

GEV No.	550849	Ref. No.	3102400 BN3102400
description	gasket for fan motor ID ø 24mm ED ø 36mm thickness 4.5mm		
For models:	CMV6ES2-1320392, CV10E, CV10E-1320100, CV10E-1320110, CV10E-2, CV10E2-1320140, CV10EB-1321100, CV10E-S, CV10ES-1320150, CV10E-S2, CV10ES2-1320190, CV10G, CV10G-1310100, CV10G-2, CV10G2-1310140, CV10GB-1311100, CV10G-S, CV10GS-1310150, CV10G-S2, CV10GS2-1310190, CV20E, CV20E-1320200, CV20E-2, CV20E2-1320240, CV20EB-1321200, CV20E-S, CV20ES-1320250, CV20E-S2, CV20ES2-1320290, CV20G, CV20G-1310200, CV20G-2, CV20G2-1310240, CV20GB-1311200, CV20G-S, CV20GS-1310250, CV20G-S2, CV20GS2-1310290, CV21E, CV21E-1322100, CV21E-2, CV21E2-1322140, CV21E-S, CV21ES-1322150, CV21E-S2, CV21ES2-1322190, CV21G, CV21G-1312100, CV21G-2, CV21G2-1312140...(Other models you can see in the webshop)		



1

GEV No.	560449	Ref. No.	3102250 BN3102250 LA58004000 LAR58004000
description	hexagonal screw thread M12x1.5 L thread L 22mm bore ø 6.3mm WS 19 total length 30mm		
For models:	CCE101M, CCE102M, CCG101M, CCG102M, CKEP10, CKEP10B, CKEP20, CKEP20B, CKEP21, CKEP21B, CKEP40, CKEP40B, CKET10, CKET10B, CKET20, CKET20B, CKET21, CKET21B, CKET40, CKET40B, CKGP10, CKGP10B, CKGP20, CKGP20B, CKGP21, CKGP21B, CKGP40, CKGP40B, CKGT10B, CKGT20, CKGT20B, CKGT21, CKGT21B, CKGT40, CKGT40B		



1

GEV No.	550861	Ref. No.	R70020020
description	shaft seal for fan motor ID ø 7.5mm ED ø 22mm thickness 7mm		
For models:	CCE042M, CCE051M, CCG051M		



			
GEV No.	511171	Ref. No.	LA70020040 LAR70020040
description	shaft seal ID \varnothing 14.5mm ED \varnothing 20mm thickness 3mm		
For models:	CCE071M, CCG071M, CKEP06, CKEP06B, CKEP10, CKEP10B, CKEP21, CKEP21B, CKET06, CKET06B, CKET10, CKET10B, CKET21, CKET21B, CKGP06, CKGP06B, CKGT06, CKGT06B		

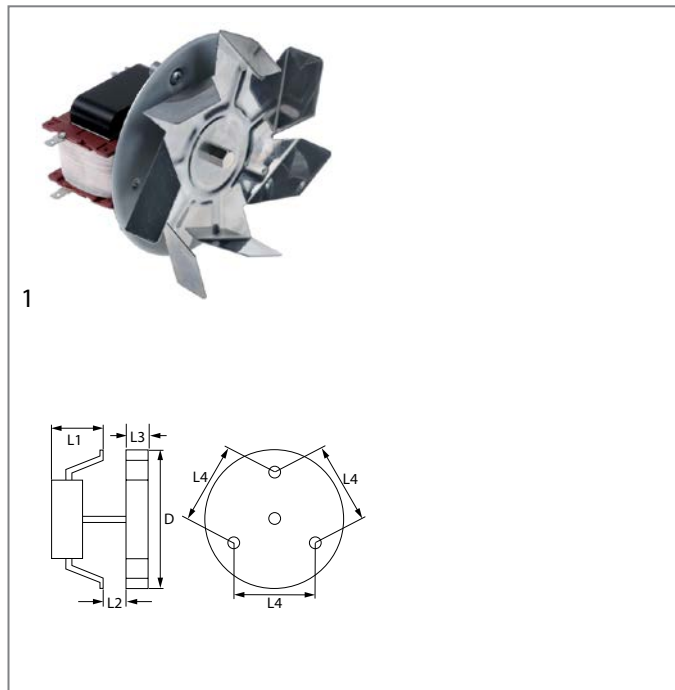

			
GEV No.	511172	Ref. No.	LA70020050 LAR70020050
description	shaft sealing ID \varnothing 24mm ED \varnothing 29mm thickness 3mm		
For models:	CCE101M, CCE102M, CCG101M, CCG102M, CKEP20, CKEP20B, CKEP40, CKEP40B, CKET20, CKET20B, CKET40, CKET40B, CKGP10, CKGP10B, CKGP20, CKGP20B, CKGP21, CKGP21B, CKGP40, CKGP40B, CKGT10B, CKGT20, CKGT20B, CKGT21, CKGT21B, CKGT40, CKGT40B		

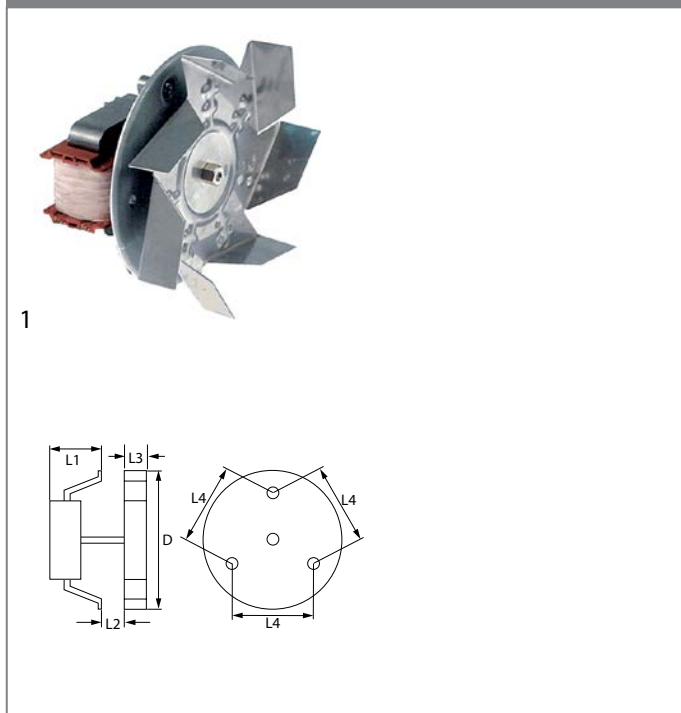

hot air fans

miscellaneous



GEV No.	601054	Ref. No.	1037117200
description	hot air fan 220-240V 32W 50/60Hz L1 60mm L2 10mm L3 25mm L4 87mm fan wheel \varnothing 150mm FIME type C20X0E01/46		
For models:	CFE60, CFE60P, OCFE60, OCFE-60-12601005, OCFE-60-12601005MN, OCFGE61		
spare parts for	601054		
		GEV No.	601441
		Ref. No.	—
	fan wheel \varnothing 150mm W 25mm shaft intake \varnothing 6x5mm stainless steel blades 7		
accessories for	601054		
		GEV No.	550879
		Ref. No.	—
	insulation \varnothing 130mm thickness 3mm hole \varnothing 18mm for hot air fan		

GEV No.	601125	Ref. No.	6A036410 BN6A036410
description	hot air fan 220-240V 45W 50/60Hz L1 70mm L2 11mm L3 25mm L4 87mm fan wheel \varnothing 150mm FIME type C30R0479CLF		
For models:	61FE-1826050, 61SCGFE3S-1826055, 61SCGFE4S-1827055, 61SECFE-1826075, 941CEAC-1292164, 941FTE1-2RAC-1292562, 941FTE1-2RAC-1292662, 941FTEAC-1292462, 941FTEACC-1292464, 941FTEACC1-2R-1292465, 941FTERAC-1292562, 94CBEAC-1192362, 94CBGAC-1191362, 94CGAC-1191164, 94CTGAC-1191760, 98CGAC-1191168, TAC100-1022005, TAC101-1022006, TAC102-1022007, TAC130-1022105, TAC131-1022106, TAC132-1022107, TAC170-1022205, TAC171-1022206, TAC172-1022207, TAC210-1019505, TAC211-1019506, TAC212-1019507, TAC6100-1622005, TAC6130-1622105, TAC6131-1622106, TAC6170-1622205		
accessories for	601125		
		GEV No.	550879
		Ref. No.	—
	insulation \varnothing 130mm thickness 3mm hole \varnothing 18mm for hot air fan		

accessories

miscellaneous

			
GEV No.	551434	Ref. No.	LA58004010 LAR58004010
description	plain washer \varnothing 30mm thickness 3mm hole \varnothing 12.5mm for fan wheel combi-steamer		
For models:	CCE101M, CCE102M, CCG101M, CCG102M, CKEP10, CKEP10B, CKEP20, CKEP20B, CKEP21, CKEP21B, CKEP40, CKEP40B, CKET10, CKET10B, CKET20, CKET20B, CKET21, CKET21B, CKET40, CKET40B, CKGP10, CKGP10B, CKGP20, CKGP20B, CKGP21, CKGP21B, CKGP40, CKGP40B, CKGT10B, CKGT20, CKGT20B, CKGT21, CKGT21B, CKGT40, CKGT40B		



radial fans



GEV No.	601181	Ref. No.	LA65060360 LAR65060360
description	radial fan 230V voltage AC 50Hz 100W H1 170mm L1 175mm D1 ø 50mm W1 115mm W2 40mm H2 45mm		
For models:	CCG051M, CCG071M, CCG101M, CCG102M, CKGP06, CKGP06B, CKGP10, CKGP10B, CKGP20, CKGP20B, CKGP21, CKGP21B, CKGP40, CKGP40B, CKGT06, CKGT06B, CKGT10, CKGT10B, CKGT20, CKGT20B, CKGT21, CKGT21B, CKGT40, CKGT40B		

accessories

fan wheels





GEV No.	601749	Ref. No.	3000125
description	fan wheel ø 174mm shaft intake ø 11mm H 54.5mm		
For models:	OLAX160, OLAX160E-1080750, OLAX160E-1080751, OLAX160V-1080755, OLAX160V-1080756, OLAX160V-1081031, OLAX160V-1081032, OLAX210, OLAX210E-1081029, OLAX210E-1081030, OLAX220, OLAX220E-1080787, OLAX220E-1080788, OLAX220V-1080789, OLAX220V-1080790, OLAX230, OLAX230E-1080791, OLAX230E-1080792, OLAX230V-1080793, OLAX230V-1080794, OLAX240, OLAX240E-1080795, OLAX240E-1080796, OLAX240V-1080797, OLAX240V-1080798, OLAX250, OLAX250E-1080760, OLAX250E-1080761, OLAX250V-1080765, OLAX250V-1080766, OLAX300, OLAX300E-1080770, OLAX300E-1080771, OLAX300E-1081033, OLAX300E-1081035, OLAX300E-1081036, OLAX300LC, OLAX300LCE-1081034, OLAX300V-1080775, OLAX300V-1080776, OLAX310, OLAX310E-1081110, OLAX310E-1081111, OLAX310LC, OLAX310LCE-1081114, OLAX310LCE-1081115, OLAX310LCV-1081116, OLAX310LCV-1081117, OLAX310V-1081112, OLAX310V-1081113...(Other models you can see in the webshop)		

motors

gear motors

for combi-steamers



GEV No.	502288	Ref. No.	LAR65090250
description	gear kit 8W 230V voltage AC 30rpm shaft ø 6mm L 75mm W 87mm H 84mm conversion kit		
For models:	CKEP06, CKEP06B, CKEP10, CKEP10B, CKEP20, CKEP20B, CKEP21, CKEP21B, CKEP40, CKEP40B, CKET06, CKET06B, CKET10, CKET10B, CKET20, CKET20B, CKET21, CKET21B, CKET40, CKET40B, CKGP06, CKGP06B, CKGP10, CKGP10B, CKGP20, CKGP20B, CKGP21, CKGP21B, CKGP40, CKGP40B, CKGT06, CKGT06B, CKGT10, CKGT10B, CKGT20, CKGT20B, CKGT21, CKGT21B, CKGT40, CKGT40B		
spare parts for	502288		
	GEV No.	502291	Ref. No. LA65090260
description	gear motor METEOR type 58U59DB4A1/00 8W 230V voltage AC 50Hz 30rpm shaft ø 6x5mm L 69mm W 49mm H 65mm		

pumps

booster pumps II

accessories





GEV No.	365015	Ref. No.	18043 LA65190180 LAR65190180
description	operating capacitor capacity 10µF 400V tolerance 5%Hz ambient temperature max. -25 to +85°C ø 35.5mm L 59mm M8 plastic connection male faston 6.3mm protection		
For models:	CCE042M, CCE051M, CCG051M, CCG071M, CKGP06, CKGP06B, OLDS37-1081006, OLDS37D-1081007, OLDS37LS-1081008, OLDS37LSD-1081009, OLDS40-1081010, OLDS40D-1081011, OLDS40LS-1081012, OLDS40LSD-1081013, OLElectron400, OLGastro450, OLLinear, OLStar		



GEV No.	502291	Ref. No.	LA65090260
description	gear motor METEOR type 58U59DB4A1/00 8W 230V voltage AC 50Hz 30rpm shaft ø 6x5mm L 69mm W 49mm H 65mm		



vibration pumps

			
1			
GEV No.	500568	Ref. No.	LAR65110600
description	vibration pump 230V 32W 50Hz inlet ø 7 outlet ø 1/8" IT CEME type E512/A32		
For models:	CKEP06, CKEP06B, CKEP10, CKEP10B, CKEP20, CKEP20B, CKEP21, CKEP21B, CKEP40, CKEP40B, CKET06, CKET06B, CKET10, CKET10B, CKET20, CKET20B, CKET21, CKET21B, CKET40, CKET40B, CKGP06, CKGP06B, CKGP10, CKGP10B, CKGP20, CKGP20B, CKGP21, CKGP21B, CKGP40, CKGP40B, CKGT06, CKGT06B, CKGT10, CKGT10B, CKGT20, CKGT20B, CKGT21, CKGT21B, CKGT40, CKGT40B		
spare parts for	500568		
	GEV No.	390698	Ref. No. —
	thermal fuse switch-off temp. 110°C suitable for ULKA pump		
	GEV No.	520153	Ref. No. —
	bracket rubber dimensions 53x34x28mm		

			
1			
GEV No.	365013	Ref. No.	16043
description	operating capacitor capacity 8µF 400V tolerance 5%Hz ambient temperature max. -25 to +85°C ø 31.5mm L 55mm M8 plastic connection male faston 6.3mm protection		

condensators & interference suppression filters

operating capacitors

<p>plastic</p> 			
1			
GEV No.	365015	Ref. No.	18043 LA65190180 LAR65190180
description	operating capacitor capacity 10µF 400V tolerance 5%Hz ambient temperature max. -25 to +85°C ø 35.5mm L 59mm M8 plastic connection male faston 6.3mm protection		
For models:	CCE042M, CCE051M, CCG051M, CCG071M, CKGP06, CKGP06B, OLDS37-1081006, OLDS37D-1081007, OLDS37LS-1081008, OLDS37LSD-1081009, OLDS40-1081010, OLDS40D-1081011, OLDS40LS-1081012, OLDS40LSD-1081013, OLElectron400, OLGastro450, OLLinear, OLStar		

			
1			
GEV No.	365021	Ref. No.	15081/A
description	operating capacitor capacity 16µF 425V tolerance 5% 50/60Hz ambient temperature max. -25 to +85°C ø 35mm L 73mm single M8 plastic connection male faston 6.3mm 416.10.99 protection		

<p>metal</p> 			
1			
GEV No.	365140	Ref. No.	15081
description	operating capacitor capacity 12.5µF 450V tolerance 5% 60Hz ambient temperature max. -25 up to +70°C ø 40mm L 83mm M8 aluminium connection male faston 6.3mm C.87.8BF2 MKP protection		
For models:	OLDS45, OLDS50, OLDS50-1081088, OLDS50D-1081089, OLDS50E-1081090, OLDS50ED-1081091, OLDS50-Neutra, OLDS50P-1081018, OLDS50PD-1081019, OLElectron500, OLG600, OLGastro500Plus, OLGastro500S, OLGastro750Plus, OLGastro750S, OLG545, OLG550, OLG550-1080705, OLG550D-1080706, OLG550E-1080730, OLG550ECO-1081014, OLG550ECOD-1081015, OLG550ED-1080731, OLG550-Neutra, OLG585, OLG585-1081016, OLG585D-1081017, OLG585-Neutra		

ferrite rings

			
1			
GEV No.	365054	Ref. No.	LAR65280490
description	ferrite ring ID ø 22mm ED ø 38mm H 17mm for protection		
For models:	CKEP06, CKEP06B, CKEP10, CKEP10B, CKEP20, CKEP20B, CKEP21, CKEP21B, CKEP40, CKEP40B, CKET06, CKET06B, CKET10, CKET10B, CKET20, CKET20B, CKET21, CKET21B, CKET40, CKET40B, CKGP06, CKGP06B, CKGP10, CKGP10B, CKGP20, CKGP20B, CKGP21, CKGP21B, CKGP40, CKGP40B, CKGT06, CKGT06B, CKGT10B, CKGT20, CKGT20B, CKGT21, CKGT21B, CKGT40, CKGT40B		

filters

<p>interference suppression filters</p> 			
1			
GEV No.	365044	Ref. No.	LA65280200 LAR65280200
description	interference suppression filter type FC701Y2F 250V 50-60Hz conductor 2 with E connection cable 200mm L 42mm ø 23mm Hmm Wmm plastic Qty 1 pcs		
For models:	CCE042M, CCE051M, CCE071M, CCE101M, CCE102M, CKEP06, CKEP06B, CKEP10, CKEP10B, CKEP20, CKEP20B, CKEP21, CKEP21B, CKEP40, CKEP40B, CKET06, CKET06B, CKET10, CKET10B, CKET20, CKET20B, CKET21, CKET21B, CKET40, CKET40B		



RC circuits

			
1			
GEV No.	365155	Ref. No.	R65280130
description	RC circuit 250/630V connection male faston 6.3mm cable length 65mm capacity 47nF 1000hm		
For models:	CCE042M		

			
1			
GEV No.	358532	Ref. No.	R65200200
description	fine fuse size ø5x20mm 2A fast-acting rated 250V Qty 10 pcs		
For models:	CCE042M, CCE051M, CCE071M, CCE101M, CCE102M, CCG051M, CCG071M, CCG101M, CCG102M, CKEP06, CKEP06B, CKEP10, CKEP10B, CKEP20, CKEP20B, CKEP21, CKEP21B, CKEP40, CKEP40B, CKET06, CKET06B, CKET10, CKET10B, CKET20, CKET20B, CKET21, CKET21B, CKET40, CKET40B, CKGP06, CKGP06B, CKGP10, CKGP10B, CKGP20, CKGP20B, CKGP21, CKGP21B, CKGP40, CKGP40B, CKGT06, CKGT06B, CKGT10B, CKGT10B, CKGT20, CKGT20B, CKGT21, CKGT21B, CKGT40, CKGT40B		

fuses

fine fuses

			
1			
GEV No.	358610	Ref. No.	15160
description	fine fuse size ø5x20mm 10A fast-acting rated 250V Qty 10 pcs		
For models:	OLAX151, OLAX151EDX-1080725, OLAX151LEFT-1080727, OLAX151-highspeed, OLAX160, OLAX160E-1080750, OLAX160E-1080751, OLAX160V-1080755, OLAX160V-1080756, OLAX160V-1081031, OLAX160V-1081032, OLAX210, OLAX210E-1081029, OLAX210E-1081030, OLAX220, OLAX220E-1080787, OLAX220E-1080788, OLAX220V-1080789, OLAX220V-1080790, OLAX230, OLAX230E-1080791, OLAX230E-1080792, OLAX230V-1080793, OLAX230V-1080794, OLAX240, OLAX240E-1080795, OLAX240E-1080796, OLAX240V-1080797, OLAX240V-1080798, OLAX250, OLAX250E-1080760, OLAX250E-1080761, OLAX250V-1080765, OLAX250V-1080766, OLAX300, OLAX300E-1080770, OLAX300E-1080771, OLAX300E-1081033, OLAX300E-1081035, OLAX300E-1081036, OLAX300LC, OLAX300LCE-1081034, OLAX300V-1080775, OLAX300V-1080776, OLAX310, OLAX310E-1081110, OLAX310E-1081111, OLAX310LC, OLAX310LCE-1081114, OLAX310LCE-1081115...(Other models you can see in the webshop)		

			
1			
GEV No.	358593	Ref. No.	R65200086
description	fine fuse size ø5x20mm 0.125A slow-acting rated 250V Qty 10 pcs		
For models:	CKEP06, CKEP06B, CKEP10, CKEP10B, CKEP20, CKEP20B, CKEP21, CKEP21B, CKEP40, CKEP40B, CKET06, CKET06B, CKET10, CKET10B, CKET20, CKET20B, CKET21, CKET21B, CKET40, CKET40B, CKGP06, CKGP06B, CKGP10, CKGP10B, CKGP20, CKGP20B, CKGP21, CKGP21B, CKGP40, CKGP40B, CKGT06, CKGT06B, CKGT10B, CKGT20, CKGT20B, CKGT21, CKGT21B, CKGT40, CKGT40B		

			
1			
GEV No.	358671	Ref. No.	15163
description	fine fuse size ø5x20mm 1A fast-acting rated 250V Qty 10 pcs		
For models:	OLAX151, OLAX151EDX-1080725, OLAX151LEFT-1080727, OLAX151-highspeed, OLAX160, OLAX160E-1080750, OLAX160E-1080751, OLAX160V-1080755, OLAX160V-1080756, OLAX160V-1081031, OLAX160V-1081032, OLAX210, OLAX210E-1081029, OLAX210E-1081030, OLAX220, OLAX220E-1080787, OLAX220E-1080788, OLAX220V-1080789, OLAX220V-1080790, OLAX230, OLAX230E-1080791, OLAX230E-1080792, OLAX230V-1080793, OLAX230V-1080794, OLAX240, OLAX240E-1080795, OLAX240E-1080796, OLAX240V-1080797, OLAX240V-1080798, OLAX250, OLAX250E-1080760, OLAX250E-1080761, OLAX250V-1080765, OLAX250V-1080766, OLAX300, OLAX300E-1080770, OLAX300E-1080771, OLAX300E-1081033, OLAX300E-1081035, OLAX300E-1081036, OLAX300LC, OLAX300LCE-1081034, OLAX300V-1080775, OLAX300V-1080776, OLAX310, OLAX310E-1081110, OLAX310E-1081111, OLAX310LC, OLAX310LCE-1081114, OLAX310LCE-1081115...(Other models you can see in the webshop)		

			
1			
GEV No.	358595	Ref. No.	R65200320
description	fine fuse size ø5x20mm 0.2A slow-acting rated 250V Qty 10 pcs		
For models:	CCE071M, CCE101M, CCE102M, CCG071M, CCG101M, CCG102M, CKEP06, CKEP06B, CKET06, CKET06B, CKGP06, CKGP06B, CKGT06, CKGT06B		

			
1			
GEV No.	358703	Ref. No.	R65200350
description	fine fuse size ø5x20mm 0.4A slow-acting rated 250V Qty 10 pcs		
For models:	CKEP10, CKEP10B, CKEP20, CKEP20B, CKEP21, CKEP21B, CKEP40, CKEP40B, CKET10, CKET10B, CKET20, CKET20B, CKET21, CKET21B, CKET40, CKET40B, CKGP10, CKGP10B, CKGP20, CKGP20B, CKGP21, CKGP21B, CKGP40, CKGP40B, CKGT10B, CKGT20, CKGT20B, CKGT21, CKGT21B, CKGT40, CKGT40B		

			
1			
GEV No.	358605	Ref. No.	6A001420 BN6A001420
description	fine fuse size ø5x20mm 3.15A slow-acting rated 250V Qty 10 pcs		
For models:	94-04PEI100L, 94-04PEI100L-12901765, 94-04PEI110L-12901765BN, 94-04PEI150L, 94-04PEI150L-12901767, 94-04PEI150L-12901767BN, 9PN-EI100, 9PN-EI150		

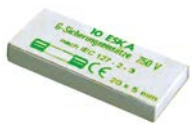

			
1			
GEV No.	358609	Ref. No.	R65200240
description	fine fuse size ø5x20mm 5A slow-acting rated 250V Qty 10 pcs		
For models:	CKET06, CKET06B, CKGT06, CKGT06B		

fine fuse holders			
			
1			
GEV No.	550104	Ref. No.	R65210020
description	fuse holder WIELAND type WK4/THSI 5 U/V0 suitable fuse ø5x30mm 0.5-6mm ² top-hat rail 35mm 10A rated 600V		

overload switches			
			
1			
GEV No.	358514	Ref. No.	R65160300
description	overload switch drop-away current 0.8A		
For models:	CKEP06, CKEP06B, CKGP06, CKGP06B		

			
1			
GEV No.	358515	Ref. No.	LA65160310 LAR65160310
description	overload switch drop-away current 2.5A		

			
1			
GEV No.	358516	Ref. No.	R65160320
description	overload switch drop-away current 2A		
For models:	CCE071M, CCG071M, CKEP06, CKEP06B, CKGP06, CKGP06B		

electric accessories

cables

accessories

cable glands

threaded cable glands

screw connections

			
1			
GEV No.	550971	Ref. No.	1037115100
description	cable gland thread PG16 cable ø 14mm mounting ø 22.5mm Qty 1 pcs plastic WS 27		
For models:	BRE40, BRE40D, BRE40DB, BRE40DG, BRE40DGB, BRE40G, BSEI40M, FTE100B, FTE100BR, FTE100CRL, FTE40B, FTE40BR, FTE40C, FTE40D, FTE40DC, FTE60B, FTE60BR, FTE60C, FTE60D, FTE60DC, FTE60DR, FTE60DRCL, OBME41M, OBME61M, OBRE40, OBRE-40-12601110, OBRE-40-12601110MN, OBSEI40M, OBSEI-40M-12601700, OFTE-100C-12601136, OFTE-100C-12601136MN, OFTE100CRL, OFTE-100CRL-12601138, OFTE40B, OFTE-40B-12601130, OFTE-40B-12601130MN, OFTE40BR, OFTE-40BR-12601132, OFTE-40BR-12601132MN, OFTE40C, OFTE-40C-12601135, OFTE-40C-12601135MN, OFTE60B, OFTE-60B-12601140, OFTE-60B-12601140MN, OFTE60BR, OFTE-60BR-12601141, OFTE-60BR-12601141MN, OFTE60BRR, OFTE-60BRR-12601142...(Other models you can see in the webshop)		

miscellaneous

			
1			
GEV No.	403839	Ref. No.	LA66110310
description	cable for combi-steamer L 370m copper insulation glass fibre braiding/silicone rubber		

			
1			
GEV No.	401960	Ref. No.	LA66110320 LAR66110320
description	kable set		
For models:	CCE071M, CCE101M, CCE102M, CCG071M, CCG101M, CCG102M, CKEP10, CKEP10B, CKEP20, CKEP20B, CKEP40, CKEP40B, CKET10, CKET10B, CKET20, CKET20B, CKET40, CKET40B, CKGP10, CKGP10B, CKGP20, CKGP20B, CKGP40, CKGP40B, CKGT10, CKGT10B, CKGT20B, CKGT40, CKGT40B		

terminals

porcelain clamps

			
1			
GEV No.	550115	Ref. No.	1037117600
description	porcelain terminal block 2-pole 10mm ² max. 30A max 450V L 37mm W 37mm H 23mm mounting distancemm Qty 1 pcs		
For models:	BSEI40M, OBSEI40M, OBSEI-40M-12601700		



connection terminals with screw/faston connections



1

GEV No.	550278	Ref. No.	1037117300
description	power terminal block 3-pole max. 40A max 400V connection $\phi 6\text{mm}^2$ / F6.3 temp.-resist. 150°C cross section 6mm ²		
For models:	BSEI40M, OBME41M, OBME61M, OBSEI40M, OBSEI-40M-12601700		



1

GEV No.	550411	Ref. No.	1037104000 500551
description	power terminal block 6-pole max. 40A max 450V connection $\phi 6\text{mm}^2$ / F6.3 temp.-resist. 150°C cross section 6mm ²		
For models:	BRE40, BRE40D, BRE40DB, BRE40DG, BRE40DGB, BRE40G, FQE41, FQE41L, FQE41L2, FQE61, FQE61L, FQE61L2, FTE100B, FTE100BR, FTE100CRL, FTE40B, FTE40BR, FTE40C, FTE40D, FTE40DC, FTE60B, FTE60BR, FTE60C, FTE60D, FTE60DC, FTE60DR, FTE60DRCL, OBRE40, OBRE-40-12601110, OBRE-40-12601110MN, OFQE41, OFQE-41-12601510, OFQE-41-12601510MN, OFQE41L, OFQE61, OFQE-61-12601610, OFQE-61-12601610MN, OFQE61L, OFTE-100C-12601136, OFTE-100C-12601136MN, OFTE100CRL, OFTE-100CRL-12601138, OFTE40B, OFTE-40B-12601130, OFTE-40B-12601130MN, OFTE40BR, OFTE-40BR-12601132, OFTE-40BR-12601132MN, OFTE40C, OFTE-40C-12601135...(Other models you can see in the webshop)		



1

GEV No.	550977 ¹	Ref. No.	6A036206 CR0588170
description	power terminal block 6-pole max. 40A max 450V connection $\phi 6\text{mm}^2$ / F6.3 temp.-resist. 150°C cross section 6mm ² with ground lug		
For models:	40SEW-1825190, 74-02CEEPEQ, 74-02CEEPEQ-12701210, 74-02CEEPT, 74-02CEEPT-12701010, 74-02CGE, 74-02CGE-12700011, 74-02CGE-12700011TA, 74-02CTEE-12701180, 74-02CTGE, 74-02CTGE-12700190, 74-02CTGE-12700190TA, 74-02KBEF-12701128, 74-02VT-CEV-12701020, 76-02CEEANPQ, 76-02CEEANPT, 76-02CEEEACPQ, 76-02CEEEACPQ, 76-02CEEECPQ-12701216, 76-02CEEEPT-12701016, 76-02CEEPQ-12701215, 76-02CEEPT-12701015, 76-02CGE, 76-02CGE-12700017, 76-02CGE-12700017TA, 76-02CGEE, 76-02CGEE-12700018, 76-02CGEE-12700018TA, 92-04CE, 92-04CEPQ-12901201, 92-04FTE-12901130, 92-04FTEC-12901135, 92-04FTECR-12901137, 92-04FTE-12901132, 92-04TCE, 92-04TCE-12931201, 92-04TFTE-12931130, 92-04TFTEC-12931135, 92-04TFTECR-12931137, 92-04TFTE-12931132, 92-04VTVC-12931005, 92-04VTVC-12901030, 92-04VTVC-12901035, 92FE-1192220, 93FE-1192230, 94-04CE, 94-04CE-12901202, 94-04CEE, 94-04CEE-12901210, 94-04CEE-12901210BN...(Other models you can see in the webshop)		

¹with ground lug

rail-mounted terminals

rail-mounted terminal blocks



1

GEV No.	550421 ¹	Ref. No.	R65220090 R65220091
description	rail-mounted terminal block 5-pole contacts 3P+N+E cross section 1.0-10mm ²		
For models:	CCE042M, CCE051M, CCE071M, CKEP06, CKEP06B, CKET06, CKET06B		

¹with fused terminal block

1

GEV No.	550420	Ref. No.	R65220080 R65220081
description	rail-mounted terminal block 5-pole contacts 3P+N+E cross section 1.5-16mm ²		
For models:	CCE101M, CKEP10, CKEP10B, CKET10, CKET10B		



1

GEV No.	550422	Ref. No.	R65220131
description	rail-mounted terminal block 9-pole		
For models:	CKEP40, CKEP40B, CKET40, CKET40B		

WIELAND

fuse terminal blocks



1







GEV No.	550104	Ref. No.	R65210020
description	fuse holder WIELAND type WK4/THSI 5 U/V0 suitable fuse $\phi 5 \times 30\text{mm}$ 0.5-6mm ² top-hat rail 35mm 10A rated 600V		





various			
			
1			
GEV No.	693955	Ref. No.	1878400 MA1878400
description	terminal grounding cable		
For models:	BRE40, BRE40D, BRE40DB, BRE40DG, BRE40DGB, BRE40G, BSEI40M, FOE30-1008310, FTE100B, FTE100BR, FTE100CRL, FTE40B, FTE40BR, FTE40C, FTE40D, FTE40DC, FTE60B, FTE60BR, FTE60C, FTE60D, FTE60DC, FTE60DR, FTE60DRCL, OBME41M, OBME-41M-12601150, OBME61M, OBME-61M-12601155, OBRE40, OBRE-40-12601110, OBRE-40-12601110MN, OBSEI40M, OBSEI-40M-12601700, OFTE-100C-12601136, OFTE-100C-12601136MN, OFTE100CRL, OFTE-100CRL-12601138, OFTE40B, OFTE-40B-12601130, OFTE-40B-12601130MN, OFTE40BR, OFTE-40BR-12601132, OFTE-40BR-12601132MN, OFTE40C, OFTE-40C-12601135, OFTE-40C-12601135MN, OFTE60B, OFTE-60B-12601140, OFTE-60B-12601140MN, OFTE60BR, OFTE-60BR-12601141...(Other models you can see in the webshop)		

accessories for 101991				
	GEV No.	101246	Ref. No.	673600 6A016120 A016120 MA673600
olive for pipe ø 4mm Qty 1 pcs				
	GEV No.	101278	Ref. No.	6A011480 86720 A011480 BN6A011480 MA86720
olive for pipe ø 10mm Qty 1 pcs				
	GEV No.	101286	Ref. No.	LA62070023 LAR62070023
olive ID ø 6mm Qty 1 pcs				
	GEV No.	101300	Ref. No.	1326500 6A011485 A011485 BN6A011485
union nut thread M16x1.5 tube ø 10mm				
	GEV No.	101450	Ref. No.	—
olive for pipe ø 8mm L 12.7mm Qty 1 pcs ED ø 10mm				
	GEV No.	101451	Ref. No.	—
union nut thread M16x1.5 tube ø 8mm				
	GEV No.	110079	Ref. No.	—
knob dial plate gas thermostat 1-8 silver				
	GEV No.	110081	Ref. No.	—
knob ø 70mm shaft ø 8x6.5mm shaft flat universal				

gas thermostats

PEL				
25ST series				
				
1				
GEV No.	101991	Ref. No.	BN41826920330	
description	gas thermostat PEL type 25ST 100-300°C gas inlet M16x1.5 (tube ø 10mm) bypass nozzle ø 0mm gas outlet M16x1.5 (tube ø 10/8mm) thermocouple connection M9x1 pilot connection M10x1 capillary pipe 1200mm probe ø 6mm probe L 100mm shaft ø 8x6.5mm shaft L 21/15mm shaft flat upper			
spare parts for	101991			
	GEV No.	101060	Ref. No.	—
magnet unit standard L 39mm D1 ø 15.4mm D2 ø 11mm suitable for PEL20-21/JUNKERS/EGA				
	GEV No.	106191	Ref. No.	—
bypass nozzle type PEL22 bore ø 0mm thread M6x0.5				
	GEV No.	106200	Ref. No.	—
nut thread M9x1 suitable for PEL 24/255				
accessories for	101991			
	GEV No.	100908	Ref. No.	673500 6A016110 6A017000 A016110 A017000 BN6A016110 BN6A017000 MA673500
union screw thread M10x1 for pipe ø 4mm Qty 1 pcs				
	GEV No.	100909	Ref. No.	LA62060223 LAR62060223
union screw thread M10x1 for pipe ø 6mm Qty 1 pcs				

gas valves and ignition boxes

gas control valves				
HONEYWELL				
				
1				
GEV No.	106012	Ref. No.	LAR63020170	
description	gas valve type VK4115V 220-240V 50/60Hz gas inlet flange 32x32mm gas outlet flange 32x32mm thermocouple connection pilot connection pressure range 15-60mbar max 60mbar operator type HONEYWELL hole distance 24mm flange 32x32mm			
For models:	CCG051M, CCG071M, CCG101M, CCG102M, CKGP06, CKGP06B, CKGP10, CKGP10B, CKGP20, CKGP20B, CKGP21, CKGP21B, CKGP40, CKGP40B, CKGT06, CKGT06B, CKGT10, CKGT10B, CKGT20, CKGT20B, CKGT21, CKGT21B, CKGT40, CKGT40B			
accessories for	106012			
	GEV No.	102845	Ref. No.	—
gas connection angled 1/2" flange 32x32mm hole distance 24x24mm Tandem				
	GEV No.	102846	Ref. No.	—
gas connection straight 1/2" flange 32x32mm hole distance 24x24mm suitable for Tandem				





SIT

ELETTROSIT











1

GEV No.	101126	Ref. No.	9000201 BN9000201
description	gas valve SIT type ELETTROSIT 230V gas inlet 1/2" gas outlet 1/2" thermocouple connection M9x1 pilot connection M10x1 bottom equiv. no. 0.810.136		
For models:	912PFRG-1103925, 914PFRG-1103950, 922FRE-1192930, 92FRG, 92FRG-1191925, 92RFRG-1391925, 94FRG, 94FRG-1191950, 94FRG-191950, 94RFRG-1391950		
spare parts for	101126		
	GEV No.	101312	Ref. No. 6A050003 A050003 BN6A050003
microswitch			
	GEV No.	101352	Ref. No. —
solenoid coil 230V 50Hz suitable for ELETTROSIT			
accessories for	101126		
	GEV No.	100006	Ref. No. —
piezoelectric igniter suitable for ELETTROSIT body plastic blowing connection ø2.4mm ø 14mm			
	GEV No.	100904	Ref. No. 1394700 6A011608 A011608 BN6A011608 MA1394700
locking screw M10x1 for pipe ø 4mm Qty 1 pcs			
	GEV No.	100905	Ref. No. 6A011607 6A011705 A011705 BN6A011705
locking screw M10x1 for pipe ø 6mm Qty 1 pcs			
	GEV No.	101301	Ref. No. —
gas connection thread 1/2" straight ELETTROSIT screw with O-ring			
	GEV No.	101303	Ref. No. —
gas connection straight thread 3/4" ELETTROSIT			
	GEV No.	101309	Ref. No. —
extension			



1







GEV No.	101127	Ref. No.	6A050000 LAR63025030
description	gas valve SIT type ELETTROSIT 230V gas inlet 3/4" gas outlet 3/4" thermocouple connection M9x1 pilot connection M10x1 lateral equiv. no. 0.810.175		
For models:	725KB-G-1000110, 725KBG-1000110, 725KB-G-1000110R, 725KB-GB-1000111, 725KB-GB-1000111R, 725KBGM-000120, 725KB-GM-1000120, 725KB-GM-1000120R, 725KB-GMB-1000121, 725KB-GMB-1000121R, 94KBG-1191870, 94KBG-191870, 94KBGM-1191880, 94KBGM-191600, 94RKBG-1391870, 94RKBGM-1391880, KB-G970-1050450, KB-G970A-1050451		
spare parts for	101127		
	GEV No.	101312	Ref. No. 6A050003 A050003 BN6A050003
microswitch			
	GEV No.	101352	Ref. No. —
solenoid coil 230V 50Hz suitable for ELETTROSIT			
accessories for	101127		
	GEV No.	100006	Ref. No. —
piezoelectric igniter suitable for ELETTROSIT body plastic blowing connection ø2.4mm ø 14mm			
	GEV No.	100904	Ref. No. 1394700 6A011608 A011608 BN6A011608 MA1394700
locking screw M10x1 for pipe ø 4mm Qty 1 pcs			
	GEV No.	100905	Ref. No. 6A011607 6A011705 A011705 BN6A011705
locking screw M10x1 for pipe ø 6mm Qty 1 pcs			
	GEV No.	101301	Ref. No. —
gas connection thread 1/2" straight ELETTROSIT screw with O-ring			
	GEV No.	101303	Ref. No. —
gas connection straight thread 3/4" ELETTROSIT			
	GEV No.	101309	Ref. No. —
extension			



NOVASIT			
			
1			
GEV No.	101908	Ref. No.	6A050010 BN6A050010 MA1871200
description	gas valve SIT series Novasit 820 230V 50Hz gas inlet 1/2" gas outlet 1/2" thermocouple connection M9x1 pilot connection M10x1 ignition pressurebar pressure regulator connection blind equiv. no. 0.820.018 output pilot burner M10x1 input pressure max. 60bar setting range 3-30bar		
For models:	74-02KBGB, 74-02KBGB-12700110, 74-02KBGBI, 74-02KBG-BI-12700115, 74-02KBGMB, 74-02KBGMB-12700120, 74-02KBGMBI, 74-02KBGMBI-12700125, 92-04FRG20L, 92-04FRG20L-12900500, 92-04FRG20L-12900500TA, 94-04FRG-12900600, 94-04FRG20L, 94-04FRG20L-12900600TA, 94-04FRG23L-12900605, 94-04KBG, 94-04KBG-12900115, 94-04KBG-12900115TA, 94-04KBG-12900118, 94-04KBG-12900118TA, 94-04KBGM, 94-04KBGM-12900125, 94-04KBGM-12900125TA, 94-04KBGM-12900128, 94-04KBGM-12900128TA, 9BR-G80, 9BR-G81, 9BR-GM80		
spare parts for	101908		
	GEV No.	101065	Ref. No. —
magnet unit with cable L 44mm D1 ø 30mm D2 ø 20mm suitable for NOVASIT			
	GEV No.	101313	Ref. No. —
solenoid coil 230V 50Hz			
accessories for	101908		
	GEV No.	100006	Ref. No. —
piezoelectric igniter suitable for ELETTROSIT body plastic blowing connection ø2.4mm ø 14mm			
	GEV No.	101305	Ref. No. —
gas connection straight 1/2" flange 45x45mm ELETTROSIT/V4400/4600/4605 suitable for SIT/HONEYWELL hole distance 36x36mm			
	GEV No.	101306	Ref. No. 3103651
gas connection angled flange 45x45mm hole distance 36x36mm 1/2" ELETTROSIT/V4400/4600/4605 screw with O-ring suitable for SIT/HONEYWELL			
	GEV No.	101307	Ref. No. —
gas connection straight flange 45x45mm hole distance 36x36mm 3/4" ELETTROSIT/V4400/4600/4605 screw with O-ring suitable for SIT/HONEYWELL			
	GEV No.	101308	Ref. No. —
gas connection angled flange 45x45mm hole distance 36x36mm 3/4" ELETTROSIT/V4400/4600/4605 screw with O-ring suitable for SIT/HONEYWELL			
	GEV No.	101312	Ref. No. 6A050003 A050003 BN6A050003
microswitch			
	GEV No.	101314	Ref. No. —
solenoid coil 24V 50Hz			
	GEV No.	101317	Ref. No. —
plug with cable L 1000mm suitable for NOVASIT			

accessories for 101908			
	GEV No.	101318	Ref. No. —
cover cap for solenoid coil suitable for NOVASIT			



1			
GEV No.	106001	Ref. No.	3103650 BN3103650
description	gas valve SIT series Novasit 826 230V 50Hz gas inlet 1/2" gas outlet 1/2" thermocouple connection pilot connection closed ignition pressure 3-5mbar pressure range 2-50mbar pressure regulator connection standard equiv. no. 0.826.011 power supply for modulator 230VAC rectified		
For models:	CV10G, CV10G-1310100, CV10G-2, CV10G2-1310140, CV10GB-1311100, CV10G-S, CV10GS-1310150, CV10G-S2, CV10GS2-1310190, CV20G, CV20G-1310200, CV20G-2, CV20G2-1310240, CV20GB-1311200, CV20G-S, CV20GS-1310250, CV20G-S2, CV20GS2-1310290, CV21G, CV21G-1312100, CV21G-2, CV21G2-1312140, CV21G-S, CV21GS-1312150, CV21G-S2, CV21GS2-1312190, CV6G, CV6G-1310000, CV6G-1310010, CV6G-2, CV6G2-1310040, CV6GB-1311000, CV6G-S, CV6GS-1310050, CV6G-S2, CV6GS2-1310090, CVM10G, CVM10G-1310400, CVM10G-1310410, CVM10G-1310430, CVM10G-1310450, CVM10G-2, CVM10G2-1310440, CVM10GP-1310400, CVM10G-S, CVM10GS-1310460, CVM10G-S2, CVM10GS2-1310490, CVM10GS2-1310495, CVM20G... (Other models you can see in the webshop)		
spare parts for	106001		
	GEV No.	101542	Ref. No. —
solenoid coil 50Hz NOVA 822/826/827 suitable for NOVASIT 230V			
accessories for	106001		
	GEV No.	101305	Ref. No. —
gas connection straight 1/2" flange 45x45mm ELETTROSIT/V4400/4600/4605 suitable for SIT/HONEYWELL hole distance 36x36mm			
	GEV No.	101306	Ref. No. 3103651
gas connection angled flange 45x45mm hole distance 36x36mm 1/2" ELETTROSIT/V4400/4600/4605 screw with O-ring suitable for SIT/HONEYWELL			
	GEV No.	101307	Ref. No. —
gas connection straight flange 45x45mm hole distance 36x36mm 3/4" ELETTROSIT/V4400/4600/4605 screw with O-ring suitable for SIT/HONEYWELL			
	GEV No.	101308	Ref. No. —
gas connection angled flange 45x45mm hole distance 36x36mm 3/4" ELETTROSIT/V4400/4600/4605 screw with O-ring suitable for SIT/HONEYWELL			
	GEV No.	101859	Ref. No. —
panel-mounted inlet with cable L 1000mm for rectifier suitable for NOVASIT			

2 gas components



accessories



GEV No.	101306	Ref. No.	3103651
description	gas connection angled flange 45x45mm hole distance 36x36mm 1/2" ELETTROSIT/V4400/4600/4605 screw with O-ring suitable for SIT/HONEYWELL		
spare parts for	101306		
	GEV No.	517104	Ref. No. 13000
	O-ring EPDM thickness 2.62mm ID ø 31.42mm Qty 1 pcs		



GEV No.	100905	Ref. No.	6A011607 6A011705 BN6A011705
description	locking screw M10x1 for pipe ø 6mm Qty 1 pcs		
For models:	7741C-GVGAS-1950266, 7742C-GV-1950267, 7961C-GVGAS-1950276, 7962C-GV-1950277		



GEV No.	101312	Ref. No.	6A050003 BN6A050003
description	microswitch		
For models:	725KB-G-1000110, 725KB-G-1000110R, 725KB-GB-1000111, 725KB-GB-1000111R, 725KB-GM-1000120, 725KB-GM-1000120R, 725KB-GMB-1000121, 725KB-GMB-1000121R, 74-02KBGB, 74-02KBGB-12700110, 74-02KBGBI, 74-02KBGBI-12700115, 74-02KBGMB, 74-02KBGMB-12700120, 74-02KBGMBI, 74-02KBGMBI-12700125, 912PFRG-1103925, 914PFRG-1103950, 92-04FRG20L, 92-04FRG20L-12900500, 92-04FRG20L-12900500TA, 922FRE-1192930, 92FRG-1191925, 94-04FRG-12900600, 94-04FRG20L, 94-04FRG20L-12900600TA, 94-04FRG23L-12900605, 94-04KBG, 94-04KBG-12900115, 94-04KBG-12900115TA, 94-04KBG-12900118, 94-04KBG-12900118TA, 94-04KBGM, 94-04KBGM-12900125, 94-04KBGM-12900125TA, 94-04KBGM-12900128, 94-04KBGM-12900128TA, 94FRG-1191950, 94KBG-1191870, 94KBGM-1191880, 94RFRG-1391950, 94RKBG-1391870, 94RKBGM-1391880, 9BR-G80, 9BR-G81, 9BR-GM80, KB-G970-1050450, KB-G970A-1050451		

ignition boxes

BRAHMA



GEV No.	102337	Ref. No.	3103675 BN3103675
description	ignition box BRAHMA type CM11F electrodes 2 waiting time 1.5s safety time 5s 220-240V 7VA 50-60Hz		
For models:	CV10G, CV10G-1310100, CV10G-2, CV10G2-1310140, CV10GB-1311100, CV10G-S, CV10GS-1310150, CV10G-S2, CV10GS2-1310190, CV20G, CV20G-1310200, CV20G-2, CV20G2-1310240, CV20GB-1311200, CV20G-S, CV20GS-1310250, CV20G-S2, CV20GS2-1310290, CV21G, CV21G-1312100, CV21G-2, CV21G2-1312140, CV21G-S, CV21GS-1312150, CV21G-S2, CV21GS2-1312190, CV6G, CV6G-1310000, CV6G-1310010, CV6G-2, CV6G2-1310040, CV6GB-1311000, CV6G-S, CV6GS-1310050, CV6G-S2, CV6GS2-1310090, CVM10G-1310400, CVM10G-1310410, CVM10G-1310430, CVM10G-1310450, CVM10G2-1310440, CVM10GS-1310460, CVM10GS2-1310490, CVM10GS2-1310495, CVM20G-1310500, CVM20G2-1310540, CVM20GS-1310550, CVM20GS2-1310590, CVM21G, CVM21G-1312400...(Other models you can see in the webshop)		

HONEYWELL



GEV No.	101184	Ref. No.	R63060140
description	ignition box HONEYWELL type S4565C 1033 equiv. no. S4565C 1033 electrodes 2 waiting times safety time 5s 220-240V 4VA 50/60Hz		
For models:	CCG051M, CCG071M, CCG101M, CCG102M		



GEV No.	103109	Ref. No.	LA63060160 LAR63060160
description	ignition box HONEYWELL type S4565C 1116 electrodes 2 waiting times safety time 5s 220-240V 4VA 50/60Hz		
For models:	CKGP06, CKGP06B, CKGP10, CKGP10B, CKGP20, CKGP20B, CKGP21, CKGP21B, CKGP40, CKGP40B, CKGT06, CKGT06B, CKGT10B, CKGT20, CKGT20B, CKGT21, CKGT21B, CKGT40, CKGT40B		









ignition parts





pilot burners

SIT

100 series



GEV No.	106902	Ref. No.	6A0131015
description	pilot burner SIT type 100 series 2 flames nozzle ø 0.2mm gas connection 6mm		
spare parts for	106902		
	GEV No.	100245	Ref. No. 1415100 6A013101 A013101 MA1415100
	pilot burner nozzle LPG code 20 bore ø 0.2mm Qty 1 pcs thread M8x0.75		
	GEV No.	100842	Ref. No. —
	pilot burner cap 2 flames Qty 1 pcs		
	GEV No.	100885	Ref. No. 6A013104 A013104 BN6A013104
	air mixing sleeve for pilot burner Qty 1 pcs		
	GEV No.	100916	Ref. No. —
	compression spring for pilot burner Qty 1 pcs		
	GEV No.	100917	Ref. No. —
	gasket for pilot burner Qty 1 pcs aluminium ID ø 8.5mm ED ø 11mm thickness 1.2mm		
	GEV No.	100918	Ref. No. —
	screw for pilot burner		
	GEV No.	107161	Ref. No. —
	pilot burner cap SIT 2 flames Hmm Lmm Qty 1 pcs		
	GEV No.	107701	Ref. No. 2510359 BN2510359
	pilot burner bottom part SIT 100 series nozzle ø 0.2mm		
accessories for	106902		
	GEV No.	100246	Ref. No. —
	pilot burner nozzle natural gas bore ø 0.35mm Qty 1 pcs thread M8x0.75		
	GEV No.	100904	Ref. No. 1394700 6A011608 A011608 BN6A011608 MA1394700
	locking screw M10x1 for pipe ø 4mm Qty 1 pcs		
	GEV No.	100905	Ref. No. 6A011607 6A011705 A011705 BN6A011705
	locking screw M10x1 for pipe ø 6mm Qty 1 pcs		
	GEV No.	102110	Ref. No. —
	pilot tube copper pipe ø 4mm thickness 1mm L 3000mm		

accessories for	106902		
	GEV No.	102111	Ref. No. —
	pilot tube copper pipe ø 6mm thickness 1mm L 3000mm		
	GEV No.	107171	Ref. No. —
	pilot burner nozzle SIT natural/liquid gas bore ø 0.25mm Qty 1 pcs		
	GEV No.	107700	Ref. No. —
	pilot burner bottom part SIT 100 series nozzle ø 0.25mm		
	GEV No.	107702	Ref. No. —
	pilot burner bottom part SIT 100 series nozzle ø 0.35mm		









	GEV No.	106906	Ref. No. 6A013200 BN6A013200 LAR63050020
description	pilot burner SIT type 100 series 3 flames nozzle ø 0.2mm gas connection 6mm		
For models:	720FRG-1077400, 720FR-G-1077450, 720FRG-1077450, 720FR-G-1077450R, 720FR-G-1077650, 722FRG-1077600, 722FR-G-1077650R, 725KB-G-1000110, 725KBG-1000110, 725KB-G-1000110R, 725KB-GB-1000111, 725KB-GB-1000111R, 725KBGM-000120, 725KB-GM-1000120, 725KB-GM-1000120R, 725KB-GMB-1000121, 725KB-GMB-1000121R, 912PFRG-1103925, 914PFRG-1103950, 922FRE-1192930, 92FRG-1191925, 92RFRG-1391925, 94FRG, 94FRG-1191950, 94RFRG-1391950, C-GV904-1050110, C-GV906-1050120, C-GV908-1050130, CT-GV904-1050220, FOGV50, FO-GV50-1959100, FOGV50-1959100, FO-GV51-1959150, FR-G925N-1050731, FR-G950N-1050733, FT-G940-1050530, FT-G940-1050531, FT-G980-1050540, FT-G980-1050541, FT-G980R1-2-1050542, KB-G970-1050450, KB-G970A-1050451, TA-GV904-1050210		
spare parts for	106906		
	GEV No.	100245	Ref. No. 1415100 6A013101 A013101 MA1415100
	pilot burner nozzle LPG code 20 bore ø 0.2mm Qty 1 pcs thread M8x0.75		
	GEV No.	100855	Ref. No. —
	pilot burner bracket triple		
	GEV No.	100885	Ref. No. 6A013104 A013104 BN6A013104
	air mixing sleeve for pilot burner Qty 1 pcs		
	GEV No.	100916	Ref. No. —
	compression spring for pilot burner Qty 1 pcs		
	GEV No.	100917	Ref. No. —
	gasket for pilot burner Qty 1 pcs aluminium ID ø 8.5mm ED ø 11mm thickness 1.2mm		
	GEV No.	100918	Ref. No. —
	screw for pilot burner		
	GEV No.	107162	Ref. No. —
	pilot burner cap SIT 3 flames Hmm Lmm Qty 1 pcs		

Table continues overleaf













spare parts for 106906			
	GEV No.	107701	Ref. No. 2510359 BN2510359
pilot burner bottom part SIT 100 series nozzle ø 0.2mm			
accessories for 106906			
	GEV No.	100245	Ref. No. 1415100 6A013101 A013101 MA1415100
pilot burner nozzle LPG code 20 bore ø 0.2mm Qty 1 pcs thread M8x0.75			
	GEV No.	100246	Ref. No. —
pilot burner nozzle natural gas bore ø 0.35mm Qty 1 pcs thread M8x0.75			
	GEV No.	100904	Ref. No. 1394700 6A011608 A011608 BN6A011608 MA1394700
locking screw M10x1 for pipe ø 4mm Qty 1 pcs			
	GEV No.	100905	Ref. No. 6A011607 6A011705 A011705 BN6A011705
locking screw M10x1 for pipe ø 6mm Qty 1 pcs			
	GEV No.	102110	Ref. No. —
pilot tube copper pipe ø 4mm thickness 1mm L 3000mm			
	GEV No.	102111	Ref. No. —
pilot tube copper pipe ø 6mm thickness 1mm L 3000mm			
	GEV No.	107171	Ref. No. —
pilot burner nozzle SIT natural/liquid gas bore ø 0.25mm Qty 1 pcs			
	GEV No.	107700	Ref. No. —
pilot burner bottom part SIT 100 series nozzle ø 0.25mm			
	GEV No.	107702	Ref. No. —
pilot burner bottom part SIT 100 series nozzle ø 0.35mm			

accessories

pilot burner bottom parts



1

GEV No.	107701	Ref. No.	2510359 BN2510359
description	pilot burner bottom part SIT 100 series nozzle ø 0.2mm		
For models:	110-135CG, 110-135CG2P, 110-135CGE, 110-135CGE2P, 110-135CGEE, 110-135CGEE2P, 110-135CGEEP, 110-135CGEP, 110-135CGG, 110-135CGG2P, 110-135CGGE, 110-135CGGE2P, 110-135CGGEP, 110-135CGGP, 110-135CGP, 110-135TCG, 110-135TCG2P, 110-135TCGP, 110-45CG, 110-45CG1P, 110-45CGP, 110-45TCG, 110-45TCG1P, 110-45TCGP, 110-90CG, 110-90CG1P, 110-90CGE, 110-90CGE1P, 110-90CGEP, 110-90CGG, 110-90CGG1P, 110-90CGGP, 110-90CGP, 110-90TCG, 110-90TCG1P, 110-90TCGP, 31FOGV-1950001, 31FOGV-1950002, 31FOGVG-1000003, 31FOGVM-1000007, 32FOGV2-1000002, 32FOGVG-1000004, 32FOGVM-1000015, 4FX, 4FX+PCF, 72+2CTGG-12700013, 72-02CG, 72-02CG-12700001, 72-02CG-12700001TA, 72-02TCG...(Other models you can see in the webshop)		
spare parts for 107701			
	GEV No.	100245	Ref. No. 1415100 6A013101 A013101 MA1415100
pilot burner nozzle LPG code 20 bore ø 0.2mm Qty 1 pcs thread M8x0.75			
	GEV No.	100916	Ref. No. —
compression spring for pilot burner Qty 1 pcs			
	GEV No.	100917	Ref. No. —
gasket for pilot burner Qty 1 pcs aluminium ID ø 8.5mm ED ø 11mm thickness 1.2mm			
	GEV No.	100918	Ref. No. —
screw for pilot burner			
accessories for 107701			
	GEV No.	100246	Ref. No. —
pilot burner nozzle natural gas bore ø 0.35mm Qty 1 pcs thread M8x0.75			
	GEV No.	100904	Ref. No. 1394700 6A011608 A011608 BN6A011608 MA1394700
locking screw M10x1 for pipe ø 4mm Qty 1 pcs			
	GEV No.	100905	Ref. No. 6A011607 6A011705 A011705 BN6A011705
locking screw M10x1 for pipe ø 6mm Qty 1 pcs			
	GEV No.	102110	Ref. No. —
pilot tube copper pipe ø 4mm thickness 1mm L 3000mm			
	GEV No.	102111	Ref. No. —
pilot tube copper pipe ø 6mm thickness 1mm L 3000mm			
	GEV No.	102742	Ref. No. —
pilot burner nozzle LPG code 25 bore ø 0.25mm Qty 1 pcs			



pilot burner nozzles			
GEV No.	100245	Ref. No.	1415100 6A013101 MA1415100
description	pilot burner nozzle LPG code 20 bore \varnothing 0.2mm Qty 1 pcs thread M8x0.75		
For models:	110-135CG, 110-135CG2P, 110-135CGE, 110-135CGE2P, 110-135CGEE, 110-135CGEE2P, 110-135CGEEP, 110-135CGEP, 110-135CGG, 110-135CGG2P, 110-135CGGE, 110-135CGGE2P, 110-135CGGEP, 110-135CGGP, 110-135CGP, 110-135TCG, 110-135TCG2P, 110-135TCGP, 110-45CG, 110-45CG1P, 110-45CGP, 110-45TCG, 110-45TCG1P, 110-45TCGP, 110-90CG, 110-90CG1P, 110-90CGE, 110-90CGE1P, 110-90CGEP, 110-90CGG, 110-90CGG1P, 110-90CGGP, 110-90CGP, 110-90TCG, 110-90TCG1P, 110-90TCGP, 4FX, 4FX+PCF, 72-02CG, 72-02TCG, 722FRG-1077600, 74-02+2CTGG, 74-02+2CTGG-12700030, 74-02CG, 74-02CGE, 74-02CGG, 74-02TCG, 76-02CG, 76-02CGE, 76-02CGEE... (Other models you can see in the webshop)		

ignition electrodes			
GEV No.	100706	Ref. No.	636700 6A013300 MA224211
description	ignition electrode connection M4 Qty 1 pcs		
For models:	720FRG-1077400, 720FR-G-1077450, 720FRG-1077450, 720FR-G-1077450R, 720FR-G-1077650, 722FRG-1077600, 722FR-G-1077650R, 725KB-G-1000110, 725KBG-1000110, 725KB-G-1000110R, 725KB-GB-1000111, 725KB-GB-1000111R, 725KBGM-000120, 725KB-GM-1000120, 725KB-GM-1000120R, 725KB-GMB-1000121, 725KB-GMB-1000121R, 76CGVFL-000070, 912PFRG-1103925, 914PFRG-1103950, 922FRE-1192930, 92FRG-1191925, 92RFRG-1391925, 94FRG, 94FRG-1191950, 94RFRG-1391950, CFG101, CFG120, CFG70, C-GV904-1050110, C-GV906-1050120, C-GV908-1050130, CT-GV904-1050220, FQG40, FQG60, FR-G925N-1050731, FR-G950N-1050733, FTG40B, FTG40BLC, FTG60B, FTG60BLC, FTG60BR, FTG80B, FTG80BR, FT-G940-1050530, FT-G940-1050531, FT-G980-1050540, FT-G980-1050541, FT-G980R1-2-1050542, KB-G970-1050450... (Other models you can see in the webshop)		















ignition electrode			
GEV No.	100707	Ref. No.	6A013302 BN6A013302
description	ignition electrode D1 \varnothing 7mm D2 \varnothing 9mm connection \varnothing 2.4mm L1 14mm L2 6mm BL1 18mm BL2 3mm BL3 23mm to clip Qty 1 pcs		
For models:	110-135CGG, 110-135CGG2P, 110-135CGGE, 110-135CGGE2P, 110-135CGGEP, 110-135CGGP, 110-45CBG, 110-45TCBG, 110-90CGG, 110-90CGG1P, 110-90CGGP, 110-90CTG, 110-90CTGE, 110-90CTGG, 110-90FTTG, 110-90FTTG1-2R, 110-90FTTGC, 110-90FTTGC1-2R, 110-90FTTGC2R, 110-90FTTGC1-2R, 110-90FTTGC2R, 110-90FTTGC1-2R, 110-90FTTGC2R, 2FX+PCF, 40SGFR-1826160, 40SGFR2S-1826160, 40SGFT-1825020, 40SGFTC-1825025, 40SGFTR-1825021, 4FX+PCF, 55-45CPG, 55-45FRG, 55-90CPG, 55-90FRG, 60SGFR-1826170, 60SGFR2S-1826170, 60SGFT1-2R-1825031, 60SGFT1-3R-1825030, 60SGFT-1825030, 60SGFTC-1825035, 60SGFTR-1825032, 710FRG-1077300, 710FR-G-1077350, 710FR-G-1077350R... (Other models you can see in the webshop)		

miscellaneous			
GEV No.	100885	Ref. No.	6A013104 BN6A013104
description	air mixing sleeve for pilot burner Qty 1 pcs		
For models:	110-135CG, 110-135CG2P, 110-135CGE, 110-135CGE2P, 110-135CGEE, 110-135CGEE2P, 110-135CGEP, 110-135CGG, 110-135CGG2P, 110-135CGGE, 110-135CGGE2P, 110-135CGGEP, 110-135CGGP, 110-135CGP, 110-135TCG, 110-135TCG2P, 110-135TCGP, 110-45CG, 110-45CG1P, 110-45CGP, 110-45TCG, 110-45TCG1P, 110-45TCGP, 110-90CG, 110-90CG1P, 110-90CGE, 110-90CGE1P, 110-90CGEP, 110-90CGG, 110-90CGG1P, 110-90CGGP, 110-90CGP, 110-90TCG, 110-90TCG1P, 110-90TCGP, 31FOGV-1950001, 31FOGV-1950002, 31FOGVG-1000003, 31FOGVM-1000007, 32FOGV2-1000002, 32FOGVG-1000004, 32FOGVM-1000015, 72+2CTGG-12700013, 72-02CG-12700001, 72-02CG-12700001TA, 72-02TCG-12730001, 72-02TCG-12730001TA, 729CAGV-1950009, 729CAGV-1950009R... (Other models you can see in the webshop)		

140 - 145 - 150 series			
GEV No.	107114 ¹	Ref. No.	CM029000
description	pilot burner SIT type 140 series 2 flames nozzle \varnothing mm gas connectionmm		
For models:	OFTG40B, OFTG-40B-12600130, OFTG40BLC, OFTG-40BLC-12600135, OFTG40BR, OFTG-40BR-12600132, OFTG60B, OFTG-60B-12600140, OFTG60BLC, OFTG-60BLC-12600145, OFTG60BR, OFTG-60BR-12600141, OFTG60BRR, OFTG-60BRR-12600142, OFTG80BLC, OFTG-80BLC-12600138		
spare parts for	107114		
	GEV No.	100907	Ref. No. 1891700
screw connection thread M10x1 Qty 1 pcs type SEF 1 \varnothing mm for thermocouple			

¹incl. thermocouple fitting
Table continues overleaf



accessories for		107114	
	GEV No.	100204	Ref. No. 1888000 6A013109 A013109 MA1888000
pilot burner nozzle SIT LPG code 14 bore \varnothing 0.18/0.20mm Qty 1 pcs suitable for 140 series			
	GEV No.	100205	Ref. No. 1033722000 22140380 822140380 BN822140380
pilot burner nozzle SIT LPG code 19 bore \varnothing 0.23/0.26mm Qty 1 pcs suitable for SIT 150 series			
	GEV No.	100206	Ref. No.
pilot burner nozzle SIT natural gas code 36 bore \varnothing 0.60/0.55mm Qty 1 pcs suitable for SIT 150 series			
	GEV No.	100207	Ref. No. 1887800 6A013107 A013107 MA1887800
pilot burner nozzle SIT natural gas code 27 bore \varnothing 0.40/0.38mm suitable for SIT 140 series			
	GEV No.	100216	Ref. No.
pilot burner nozzle SIT natural gas code 38 bore \varnothing 0.45mm Qty 1 pcs suitable for SIT 150 series			
	GEV No.	100701	Ref. No. 1888300 1949900 41826650010 826650010 BN41826650010 MA1888300 MA1949900
ignition electrode connection M4 Qty 1 pcs			
	GEV No.	100801	Ref. No.
gasket for pilot burner Qty 1 pcs			
	GEV No.	100897	Ref. No. 1881000 1888100 22450050 MA1888100
olive for pipe \varnothing 4mm Qty 1 pcs for pilot burner			
	GEV No.	100898	Ref. No. 41822450470 6A011706 A011706 BN41822450470 BN6A011706
olive for pipe \varnothing 6mm Qty 1 pcs for pilot burner			
	GEV No.	100906	Ref. No. 1888400 6A011707 A011707 MA1888400
screw connection thread M10x1 for ignition electrode brass Qty 1 pcs WS 10			
	GEV No.	100908	Ref. No. 673500 6A016110 6A017000 A016110 A017000 BN6A016110 BN6A017000 MA673500
union screw thread M10x1 for pipe \varnothing 4mm Qty 1 pcs			
	GEV No.	100909	Ref. No. LA62060223 LAR62060223
union screw thread M10x1 for pipe \varnothing 6mm Qty 1 pcs			
	GEV No.	102110	Ref. No.
pilot tube copper pipe \varnothing 4mm thickness 1mm L 3000mm			
	GEV No.	102111	Ref. No.
pilot tube copper pipe \varnothing 6mm thickness 1mm L 3000mm			





POLIDORO			
pilot burners			
	GEV No.	100076	Ref. No. 6A013220 BN6A013220
description pilot burner POLIDORO 3 flames natural gas code 29.2 gas connection 6mm			
For models: 110-135CGG, 110-135CGG2P, 110-135CGGE, 110-135CGGE2P, 110-135CGGEP, 110-135CGGP, 110-90CGG, 110-90CGG1P, 110-90CGGP, 110-90CTG, 110-90CTGE, 110-90CTGG, 110-90FTTG, 110-90FTTG1-2R, 110-90FTTGC, 110-90FTTGC1-2R, 110-90FTTGCR, 110-90FTTGE, 110-90FTTGG, 110-90FTTGR, 110-90TCTG, 110-90TCTG1-2R, 110-90TCTGC, 110-90TCTGC1-2R, 110-90TCTGCR, 110-90TCTGR, 2FX+PCF, 40SGFR, 40SGFR-1826160, 40SGFR2S-1826160, 4FX+PCF, 55-45CPG, 55-45FRG, 55-90CPG, 55-90FRG, 60SGFR, 60SGFR-1826170, 60SGFR2S-1826170, 714CTGV-000190, 714CT-GV-1000170, 714CTGV-1000170, 714CTGV-1000170R, 714CT-GVFE-1000180, 714CTGVFE-1000180, 714CT-GVFE-1000180R, 714TAGV-000190, 714TA-GV-1000190, 714TA-GV-1000190R, 716CTG-000195...(Other models you can see in the webshop)			
spare parts for 100076			
	GEV No.	100907	Ref. No. 1891700
screw connection thread M10x1 Qty 1 pcs type SEF 1 \varnothing mm for thermocouple			
accessories for 100076			
	GEV No.	100000	Ref. No.
pilot burner nozzle POLIDORO LPG code 22 bore \varnothing 0.22mm Qty 1 pcs			
	GEV No.	100208	Ref. No.
pilot burner nozzle POLIDORO LPG code 20 bore \varnothing 0.2mm Qty 1 pcs			
	GEV No.	100209	Ref. No.
pilot burner nozzle POLIDORO natural gas code 40 bore \varnothing 0.4mm Qty 1 pcs			
	GEV No.	100701	Ref. No. 1888300 1949900 41826650010 826650010 BN41826650010 MA1888300 MA1949900
ignition electrode connection M4 Qty 1 pcs			
	GEV No.	100906	Ref. No. 1888400 6A011707 A011707 MA1888400
screw connection thread M10x1 for ignition electrode brass Qty 1 pcs WS 10			
	GEV No.	100907	Ref. No. 1891700
screw connection thread M10x1 Qty 1 pcs type SEF 1 \varnothing mm for thermocouple			
	GEV No.	100908	Ref. No. 673500 6A016110 6A017000 A016110 A017000 BN6A016110 BN6A017000 MA673500
union screw thread M10x1 for pipe \varnothing 4mm Qty 1 pcs			
	GEV No.	100909	Ref. No. LA62060223 LAR62060223
union screw thread M10x1 for pipe \varnothing 6mm Qty 1 pcs			

Table continues overleaf



accessories for		100076	
	GEV No.	102110	Ref. No. —
pilot tube copper pipe ø 4mm thickness 1mm L 3000mm			
	GEV No.	102111	Ref. No. —
pilot tube copper pipe ø 6mm thickness 1mm L 3000mm			
	GEV No.	102508	Ref. No. —
union screw thread M10x1 for pipe ø 4mm Qty 5 pcs			
	GEV No.	102509	Ref. No. —
union screw thread M10x1 for pipe ø 6mm Qty 5 pcs			
	GEV No.	102699	Ref. No. —
pilot burner nozzle POLIDORO natural gas code 25.2 bore ø 2x0.25mm Qty 1 pcs 2 bores			
	GEV No.	102795	Ref. No. —
olive for pipe ø 4mm Qty 1 pcs			
	GEV No.	102797	Ref. No. —
olive for pipe ø 6mm Qty 1 pcs			
	GEV No.	106703	Ref. No. 6A013230 A013230 BN6A013230
pilot burner nozzle POLIDORO natural gas code 27.2 bore ø 2x0.27mm Qty 1 pcs			
	GEV No.	106704	Ref. No. 6A013240 A013240 BN6A013240
pilot burner nozzle POLIDORO LPG code 16.2 bore ø 2x0.16mm Qty 1 pcs			
	GEV No.	106763	Ref. No. —
pilot burner nozzle POLIDORO natural gas code 27.2A bore ø 2x 0.27mm Qty 1 pcs			
	GEV No.	106859	Ref. No. —
pilot burner nozzle POLIDORO LPG code 24 bore ø 0.24mm Qty 1 pcs			

electrodes

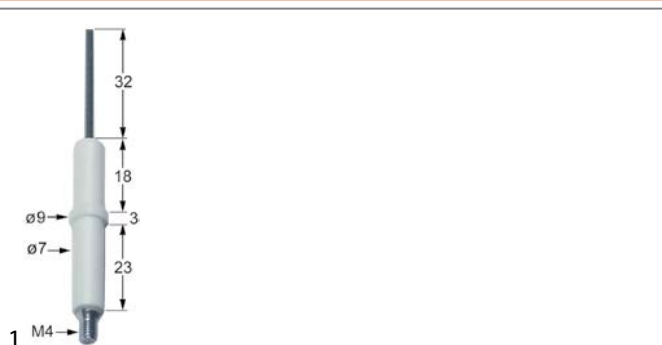

GEV No.	100701	Ref. No.	1888300 1949900 41826650010 BN41826650010 MA1888300 MA1949900
---------	--------	----------	--

description ignition electrode connection M4 Qty 1 pcs

For models: 7FT-G400, 7FT-G410, 7FT-G800, 7FT-G810, 7FT-G820, 7FTTF-G800, 7FTTF-G805, 7FTTF-G820, 7FTTF-G825, 7FTTF-GE800, 7FTTF-GE805, 7FTTF-GE820, 7FTTF-GE825, 7FTT-G400, 7FTT-G405, 7FTT-G410, 7FTT-G415, 7FTT-G800, 7FTT-G805, 7FTT-G806, 7FTT-G810, 7FTT-G815, 7FTT-G820, 7FTT-G825, 7FTTV-G400, 7FTTV-G405, 7FTTV-G410, 7FTTV-G415, 7FTTV-G800, 7FTTV-G805, 7FTTV-G810, 7FTTV-G815, 7FTTV-G820, 7FTTV-G825, 7FTV-G400, 7FTV-G410, 7FTV-G800, 7FTV-G810, 7FTV-G820, 7PCF-G120, 7PCF-G121, 7PCF-G160, 7PCF-G161, 7PCF-G800, 7PCF-G811, 7PCF-GE121, 7PCF-GE161, 7PCF-GE411, 7PC-G121, 7PC-G161...(Other models you can see in the webshop)

accessories for		100701	
	GEV No.	100906	Ref. No. 1888400 6A011707 A011707 MA1888400
screw connection thread M10x1 for ignition electrode brass Qty 1 pcs WS 10			



GEV No.	100706	Ref. No.	636700 6A013300 MA224211
---------	--------	----------	--------------------------------

description ignition electrode connection M4 Qty 1 pcs

For models: 720FRG-1077400, 720FR-G-1077450, 720FRG-1077450, 720FR-G-1077450R, 720FR-G-1077650, 722FRG-1077600, 722FR-G-1077650R, 725KB-G-1000110, 725KBG-1000110, 725KB-G-1000110R, 725KB-GB-1000111, 725KB-GB-1000111R, 725KBGM-000120, 725KB-GM-1000120, 725KB-GM-1000120R, 725KB-GMB-1000121, 725KB-GMB-1000121R, 76CGVFL-000070, 912PFRG-1103925, 914PFRG-1103950, 922FRE-1192930, 92FRG-1191925, 92RFRG-1391925, 94FRG, 94FRG-1191950, 94RFRG-1391950, CFG101, CFG120, CFG70, C-GV904-1050110, C-GV906-1050120, C-GV908-1050130, CT-GV904-1050220, FQG40, FQG60, FR-G925N-1050731, FR-G950N-1050733, FTG40B, FTG40BLC, FTG60B, FTG60BLC, FTG60BR, FTG80B, FTG80BR, FT-G940-1050530, FT-G940-1050531, FT-G980-1050540, FT-G980-1050541, FT-G980R1-2-1050542, KB-G970-1050450...(Other models you can see in the webshop)

gas components

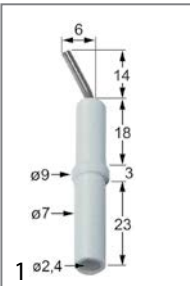
GEV No.	100707	Ref. No.	6A013302 BN6A013302
description	ignition electrode D1 ø 7mm D2 ø 9mm connection ø2.4mm L1 14mm L2 6mm BL1 18mm BL2 3mm BL3 23mm to clip Qty 1 pcs		
For models:	110-135CGG, 110-135CGG2P, 110-135CGGE, 110-135CGGE2P, 110-135CGGEP, 110-135CGGP, 110-45CBG, 110-45TCBG, 110-90CGG, 110-90CGG1P, 110-90CGGP, 110-90CTG, 110-90CTGE, 110-90CTGG, 110-90FTTG, 110-90FTTG1-2R, 110-90FTTGC, 110-90FTTGC1-2R, 110-90FTTGR, 110-90FTTGE, 110-90FTTGG, 110-90FTTGR, 110-90CTG, 110-90FTTG, 110-90FTTG1-2R, 110-90FTTGC, 110-90FTTGC1-2R, 110-90FTTGR, 110-90FTTGR, 2FX+PCF, 40SGFR-1826160, 40SGFR2S-1826160, 40SGFT-1825020, 40SGFTC-1825025, 40SGFTR-1825021, 4FX+PCF, 55-45CPG, 55-45FRG, 55-90CPG, 55-90FRG, 60SGFR-1826170, 60SGFR2S-1826170, 60SGFT1-2R-1825031, 60SGFT1-3R-1825030, 60SGFT-1825030, 60SGFTC-1825035, 60SGFTR-1825032, 710FRG-1077300, 710FR-G-1077350, 710FR-G-1077350R...(Other models you can see in the webshop)		

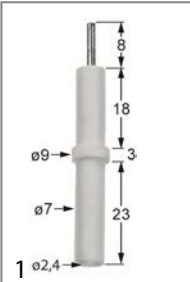

GEV No.	106619	Ref. No.	6A013301 BN6A013301
description	ignition electrode D1 ø 7mm D2 ø 9mm L1 8mm BL1 18mm BL2 3mm BL3 23mm to clip connection ø 2.4mm		
For models:	40SGFR, 40SGFT, 40SGFTC, 40SGFTR, 60SGFR, 60SGFT, 60SGFTC, 716CTG-000195, 716CTGV-000195, 72CAGV-000010, 74CAGV-000020, 74CGV-000040, 76CAGV-000030, 76CGV-000050, 76CGVFL-000070, 78PLG, 7BR-G100, 7BR-G105, 7BRS-G100, 7BRS-G105, 7FT-G400, 7FT-G410, 7FT-G800, 7FT-G810, 7FT-G820, 7FTTF-G800, 7FTTF-G805, 7FTTF-G820, 7FTTF-G825, 7FTTF-GE800, 7FTTF-GE805, 7FTTF-GE820, 7FTTF-GE825, 7FTT-G400, 7FTT-G405, 7FTT-G410, 7FTT-G415, 7FTT-G800, 7FTT-G805, 7FTT-G810, 7FTT-G815, 7FTT-G820, 7FTT-G825, 7FTTV-G400, 7FTTV-G405, 7FTTV-G410, 7FTTV-G415, 7FTTV-G800, 7FTTV-G805, 7FTTV-G810...(Other models you can see in the webshop)		

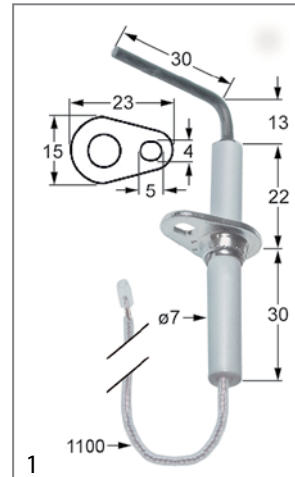

GEV No.	102335	Ref. No.	3104900 BN3104900
description	ignition electrode flange length 23mm flange width 15mm D1 ø 7mm L1 13mm L2 30mm BL1 22mm BL2 30mm cable length 1100mm fixing dimensions ø5x4mm with flange		
For models:	CV10G, CV10G-1310100, CV10G-2, CV10G2-1310140, CV10GB-1311100, CV10G-S, CV10GS-1310150, CV10G-S2, CV10GS2-1310190, CV20G, CV20G-1310200, CV20G-2, CV20G2-1310240, CV20GB-1311200, CV20G-S, CV20GS-1310250, CV20G-S2, CV20GS2-1310290, CV21G, CV21G-1312100, CV21G-2, CV21G2-1312140, CV21G-S, CV21GS-1312150, CV21G-S2, CV21GS2-1312190, CV6G, CV6G-1310000, CV6G-1310010, CV6G-2, CV6G2-1310040, CV6GB-1311000, CV6G-S, CV6GS-1310050, CV6G-S2, CV6GS2-1310090, CVM10G, CVM10G-1310400, CVM10G-1310410, CVM10G-1310430, CVM10G-1310450, CVM10G-2, CVM10G2-1310440, CVM10GP-1310400, CVM10G-S, CVM10GS-1310460, CVM10G-S2, CVM10GS2-1310490, CVM10GS2-1310495, CVM20G...(Other models you can see in the webshop)		

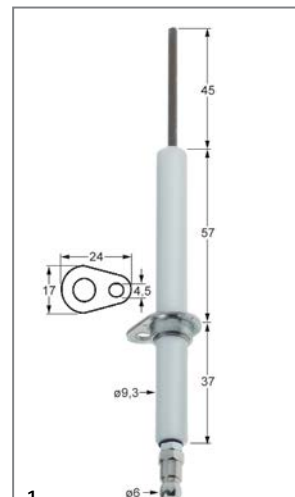

GEV No.	106756	Ref. No.	LAR63050130
description	ignition electrode flange length 24mm flange width 17mm D1 ø 9.3mm L1 45mm BL1 57mm BL2 37mm connection ø6 fixing dimensions ø4.5mm A1/B13/C2		
For models:	CCG051M, CCG071M, CCG101M, CCG102M, CKGP06, CKGP06B, CKGP10, CKGP10B, CKGP20, CKGP20B, CKGP21, CKGP21B, CKGP40, CKGP40B, CKGT06, CKGT06B, CKGT10, CKGT10B, CKGT20, CKGT20B, CKGT21, CKGT21B, CKGT40, CKGT40B		

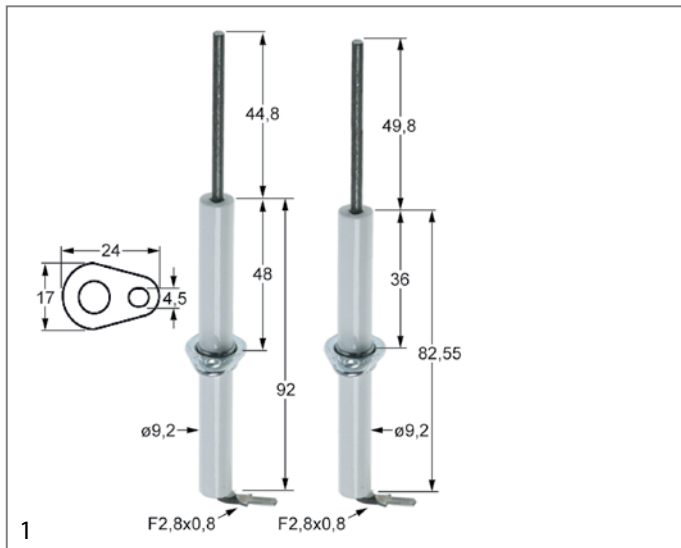

GEV No.	106647	Ref. No.	R63050100
description	ignition electrode set flange length 24mm flange width 17mm D1 ø 9.5mm L1 45mm BL1 48mm BL2 48mm connection male faston 2.8mm with screw connection 1x ignition 1x flame monitoring		
For models:	CKGP06, CKGP06B, CKGT06, CKGT06B		



GEV No.	100906	Ref. No.	1888400 6A011707 MA1888400
description	screw connection thread M10x1 for ignition electrode brass Qty 1 pcs WS 10		
For models:	7FT-G400, 7FT-G410, 7FT-G800, 7FT-G810, 7FT-G820, 7FTTF-G800, 7FTTF-G805, 7FTTF-G820, 7FTTF-G825, 7FTTF-GE800, 7FTTF-GE805, 7FTTF-GE820, 7FTTF-GE825, 7FTT-G400, 7FTT-G405, 7FTT-G410, 7FTT-G415, 7FTT-G800, 7FTT-G805, 7FTT-G810, 7FTT-G815, 7FTT-G820, 7FTT-G825, 7FTTV-G400, 7FTTV-G405, 7FTTV-G410, 7FTTV-G415, 7FTTV-G800, 7FTTV-G805, 7FTTV-G810, 7FTTV-G815, 7FTTV-G820, 7FTTV-G825, 7FTV-G400, 7FTV-G410, 7FTV-G800, 7FTV-G810, 7FTV-G820, 7PCF-G120, 7PCF-G121, 7PCF-G160, 7PCF-G161, 7PCF-G800, 7PCF-G811, 7PCF-GE121, 7PCF-GE161, 7PCF-GE411, 7PC-G121, 7PC-G161, 7PC-G411...(Other models you can see in the webshop)		

ignition cables

pre-assembled cables

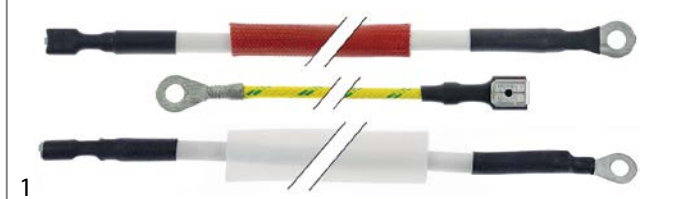

GEV No.	107856	Ref. No.	R66605810
description	ignition cable 3-piece L 1080mm		
For models:	CKGP40, CKGP40B, CKGT40, CKGT40B		

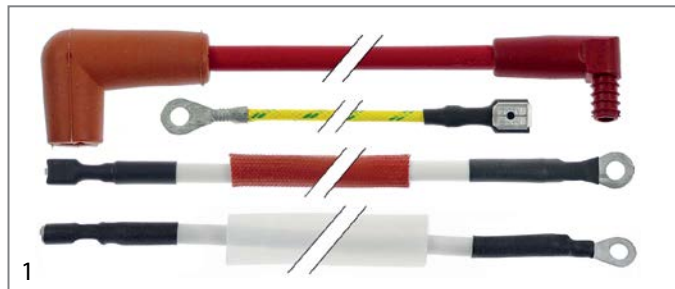

GEV No.	107857	Ref. No.	R66605820
description	ignition cable 4-piece L 520mm		
For models:	CCG051M, CCG071M, CCG101M, CCG102M, CKGP06B, CKGP10B, CKGP21, CKGP21B, CKGT06B, CKGT10B, CKGT21, CKGT21B		



GEV No.	100026	Ref. No.	2532997 6A013000 9000231 BN2532997 BN6A013000
description	ignition cable cable length 1000mm connection ø4mm / F6.3mm		
For models:	710FR-G-1077350, 712FR-G-1077550, 714CTGV-000190, 714CTGV-1000170, 714CTGV-1000170, 714CTGV-1000170R, 714TAGV-000190, 716CTG-000195, 716CTGV-000195, 720FRG-1077400, 720FR-G-1077450, 720FRG-1077450, 720FR-G-1077450R, 720FR-G-1077650, 722FRG-1077600, 722FR-G-1077650R, 725KB-G-1000110, 725KBG-1000110, 725KB-G-1000110R, 725KB-G-1000111, 725KB-G-1000111R, 725KBGM-000120, 725KB-GM-1000120, 725KB-GM-1000120R, 725KB-GMB-1000121, 725KB-GMB-1000121R, 749CGV-000039, 749CGV-1950039, 749CGV-1950039R, 74CGV-000040, 769CGV-000049, 769CGV-1950049, 769CGV-1950049R, 769CGVAC-1950079, 769CGVAC-1950079R, 769CGVFL-000069, 769CGVFL-1950069, 769CGVFL-1950069R, 769CT-GV-1950194, 769CT-GV-1950194R, 76CGVFL-000070, 914PCGG-1103214, 914PCTGG-1103711, 914PFTGG-1103413, 914PFTGG-1103415, 916PCGGAN-1103216, 916PCGG-1103236, 918PCGG-1103218, 92FG-1191220, 941CTGG-1291710...(Other models you can see in the webshop)		



GEV No.	100195	Ref. No.	1950324
description	ignition cable cable length 1200mm connection ø2.4mm / lug M4		
For models:	CFG101, CFG120, CFG70, OCFG101, OCFG-101-12600025, OCFG120, OCFG70, OCFG-70-12600000, OPCG-41-12600010		





GEV No.	100140	Ref. No.	835909
description	ignition cable cable length 400mm connection ø2.4mm / ø4mm		



GEV No.	100186	Ref. No.	1936300
description	ignition cable cable length 600mm connection ø2.4mm / lug M4		
For models:	FQG40, FQG60, FTG40B, FTG40BLC, FTG60B, FTG60BLC, FTG60BR, FTG80B, FTG80BR, OFTG40B, OFTG-40B-12600130, OFTG40BLC, OFTG-40BLC-12600135, OFTG40BR, OFTG-40BR-12600132, OFTG60B, OFTG-60B-12600140, OFTG60BLC, OFTG-60BLC-12600145, OFTG-60BR, OFTG-60BR-12600141, OFTG60BRR, OFTG-60BRR-12600142, OFTG80B, OFTG80BLC, OFTG-80BLC-12600138, OFTG80BR, OPLG40, OPLG-40-12600850, OPLG80, OPLG-80-12600855, PLG40, PLG80		

2 gas components

			
GEV No.	100016	Ref. No.	2510698 826690011 BN2510698
description	ignition cable cable length 900mm connection ø2.4mm / ø2.4mm		
For models:	110-135CGG, 110-135CGG2P, 110-135CGGE, 110-135CGGE2P, 110-135CGGEP, 110-135CGGP, 110-45CBG, 110-45TCBG, 110-90CGG, 110-90CGG1P, 110-90CGGP, 110-90CTGG, 110-90FTTGG, 55-45FRG, 55-90FRG, 714CTGV-000190, 714CT-GV-1000170, 714CTGV-1000170, 714CTGV-1000170R, 714CT-GVFE-1000180, 714CTGVFE-1000180, 714CT-GVFE-1000180R, 714TAGV-000190, 714TA-GV-1000190, 714TA-GV-1000190R, 72-02CBG, 72-02CBG-12700150, 72-02CPG, 72-02CPG-12700900, 72-02FRG, 72-02FRG-12700500, 72-02FRG17-12700505, 72-02FTG, 72-02FTG-12700130TA, 72-02FTG-12700300, 72-02FTG-12700300TA, 72-02FTGC-12700135, 72-02FTGC-12700135TA, 72-02FTGCVAL, 72-02FTGR, 72-02FTGR-12700132TA, 72-02FTGR-12700302, 72-02FTGR-12700302TA, 72-02FTGRVAL, 72-02FTGVAL, 72-02FTTG-12700130, 72-02FTTGR-12700132, 72-02PLG, 72-02PLG-12700850, 72-02PLG-12700850TA...(Other models you can see in the webshop)		

			
GEV No.	107786	Ref. No.	LA66605120 LAR66605120
description	ignition cable ID ø 7/4mm thicknessmm Qty 1m silicone permanent temperature°C t.max. 155°C flashover voltage 30000V red L 800mm		

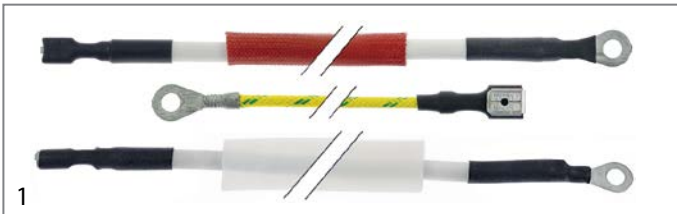
			
GEV No.	107854	Ref. No.	R66605800
description	ignition cable set 3-piece L 700mm		
For models:	CKGP06, CKGP06B, CKGP10, CKGP10B, CKGP20, CKGP20B, CKGP21B, CKGT06, CKGT06B, CKGT10, CKGT10B, CKGT20, CKGT20B, CKGT21B		

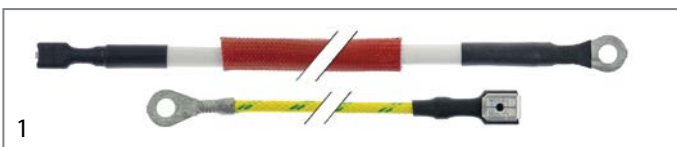
			
GEV No.	107787	Ref. No.	LAR66605801
description	ignition cable set L 700mm		

ignition units

			
GEV No.	104688	Ref. No.	LA65180270 LAR65180270
description	ignition unit outputs 1 220-240VAC dimensions 84x62x38mm mounting distance 59mm inlet F6.3x0.8 outlet ø4mm type TRK2-30PVD 69VA 50/60Hz 0.3A protection IP00		
For models:	CKGP06, CKGP06B, CKGP10, CKGP10B, CKGP20, CKGP20B, CKGP21, CKGP21B, CKGP40, CKGP40B, CKGT06, CKGT06B, CKGT10B, CKGT20, CKGT20B, CKGT21, CKGT21B, CKGT40, CKGT40B		

			
GEV No.	102485	Ref. No.	6A050100 6A050105 BN6A050100 MA2971400
description	ignition unit outputs 2 220-240VAC 0.6VA 50-60Hz		
For models:	2FX+PCF, 4FX+PCF, 72+2CTGG-12700013, 72-02FRGM, 72-02FRGM-12700530, 72-02FRGM-12700530TA, 725KB-G-1000110, 725KB-G-1000110R, 725KB-G-1000111, 725KB-G-1000111R, 725KB-GM-1000120, 725KB-GM-1000120R, 725KB-GMB-1000121, 725KB-GMB-1000121R, 73-02FRGM, 73-02FRGM-12700580, 73-02FRGM-12700580TA, 74+2CTGGAN-12700025, 74-02FRGM, 74-02FRGM-12700630, 74-02KBGB, 74-02KBGB-12700110, 74-02KBGBI, 74-02KBGBI-12700115, 74-02KBGMB, 74-02KBGMB-12700120, 74-02KBGMBI, 74-02KBGMBI-12700125, 796CG-000270, 912PFRG-1103925, 914PFRG-1103950, 92-04FRG20L, 92-04FRG20L-12900500, 92-04FRG20L-12900500TA, 922FRE-1192930, 92FRG-1191925, 92RFRG-1391925, 94-04FRG-12900600, 94-04FRG20L, 94-04FRG20L-12900600TA, 94-04FRG23L-12900605, 94-04KBG, 94-04KBG-12900115, 94-04KBG-12900115TA, 94-04KBG-12900118, 94-04KBG-12900118TA, 94-04KBGM, 94-04KBGM-12900125, 94-04KBGM-12900125TA, 94-04KBGM-12900128...(Other models you can see in the webshop)		

			
GEV No.	101002	Ref. No.	6A050101
description	ignition unit outputs 2 230VAC dimensions 88x23x34mm mounting distance 73mm inlet F6.3x0.8 outlet F2.8x0.8 0.6VA 50/60Hz		
For models:	716CTG-000195, 716CTGV-000195, 72CAGV-000010		

thermocouples

plug-in thermocouples

plug-in thermocouples standard

with barrel socket ø6(6.5)mm

thermocouples SIT

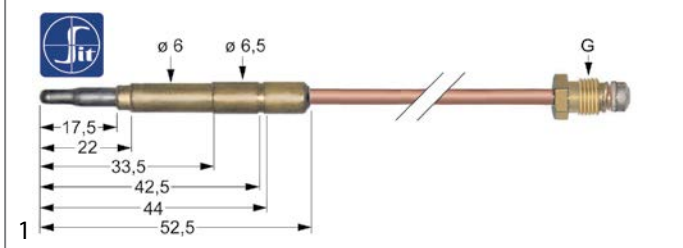

GEV No.	107601	Ref. No.	1033027800 1206400
description	thermocouple SIT M8x1 L 600mm plug connection ø6.0(6.5)mm		
For models:	CFG101, CFG120, CFG70, CFGE61, CFGE61D, CFGE61L, CFGE61P, FTG40B, FTG40BLC, FTG60B, FTG60BLC, FTG60BR, FTG80B, FTG80BR, OCFG101, OCFG-101-12600025, OCFG120, OCFG70, OCFG-70-12600000, OCFGE61, OFTG40B, OFTG40BLC, OFTG60B, OFTG60BLC, OFTG60BR, OFTG80B, OFTG80BR, OPCG41, OPCG-41-12600010, OPCG61		



GEV No.	107606	Ref. No.	1031500400 6A011906
description	thermocouple SIT M9x1 L 320mm plug connection ø6.0(6.5)mm		
For models:	716CTG-000195, 716CTGV-000195, 72CAGV-000010, 74CAGV-000020, 74CGV-000040, 76CAGV-000030, 76CGV-000050, 76CGVFL-000070, 7741CGV-1950226, 7741CGV-1950266, 7741C-GVGAS-1950266, 7742C-GV-1950267, 7742CGV-1950267, 7961CGV-1950276, 7961C-GVGAS-1950276, 7962C-GV-1950277, 7962CGV-1950277, FQG40, FQG60		

GEV No.	107609	Ref. No.	6A011903 A011909 BN6A011903
description	thermocouple SIT M9x1 L 600mm plug connection ø6.0(6.5)mm		
For models:	40SGFR, 40SGFR-1826160, 40SGFR2S-1826160, 60SGFR, 60SGFR-1826170, 60SGFR2S-1826170, 710FRG-1077300, 710FR-G-1077350, 710FR-G-1077350R, 712FR-G-1077550, 712FRG-1077550, 712FR-G-1077550R, 72-02CPG, 72-02CPG-12700900, 72-02FRG, 72-02FRG-12700500, 720FRG-1077400, 720FR-G-1077450, 720FRG-1077450, 720FR-G-1077450R, 720FR-G-1077650, 722FRG-1077600, 722FR-G-1077650R, 73-02FRG, 73-02FRG-12700550, 74-02CPG, 74-02CPG-12700905, 74-02CPG-12700905TA, 74-02FRG, 74-02FRG-12700600, 74-02FRG17-12700605, 7CP-G400, 7CP-G800, 9122PFRG-1103930, 912PFRG-1103925, 914PFRG-1103950, 914PFTGE-1103423, 914PFTGEC-1103425, 914PFTGG-1103413, 914PFTGGC-1103415, 914PFTTG-1103493, 914PFTTG1-2R-1103693, 914PFTGC-1103497, 914PFTGR-1103593, 92-04CPG, 92-04CPG-12900900, 92-04CPG-12900900TA, 92-04FTTG, 922FRE-1192930, 922FRG-1191930...(Other models you can see in the webshop)		

GEV No.	107608	Ref. No.	1031504300 6A011901 6A011902 6A011912 BN6A011901 BN6A011902 BN6A011912 MA1031504300
description	thermocouple SIT M9x1 L 500mm plug connection ø6.0(6.5)mm		
For models:	110-45CBG, 110-45TCBG, 2FX+PCF, 4FX+PCF, 72+2CTGG-12700013, 72-02CBG, 72-02CBG-12700150, 72-02FTG, 72-02FTG-12700130TA, 72-02FTG-12700300, 72-02FTG-12700300TA, 72-02FTGC-12700135, 72-02FTGC-12700135TA, 72-02FTGVAL, 72-02FTGVAL, 72-02FTTG-12700130, 72-02FTTGR-12700132TA, 72-02FTGR-12700302, 72-02FTGR-12700302TA, 72-02FTGRVAL, 72-02FTGVAL, 72-02FTTG-12700130, 72-02FTTGR-12700132, 72-02PLG, 72-02PLG-12700850, 72-02PLG-12700850TA, 72-02TCBG, 72-02TCBG-12730150, 72-02TFTG, 72-02TFTG-12730130, 72-02TFTG-12730130TA, 72-02TFTG-12730300, 72-02TFTG-12730300TA, 72-02TFTGC-12730135, 72-02TFTGC-12730135TA, 72-02TFTGVAL, 72-02TFTGR, 72-02TFTGR-12730132, 72-02TFTGR-12730132TA, 72-02TFTGR-12730302, 72-02TFTGR-12730302TA, 72-02TFTGRVAL, 72-02TFTGVAL, 72-02TPLG, 72-02TPLG-12730850, 72-02TPLG-12730850TA, 725KB-G-1000110, 725KBG-1000110, 725KB-G-1000110R, 725KB-GB-1000111, 725KB-GB-1000111R...(Other models you can see in the webshop)		

GEV No.	107611	Ref. No.	1916000 6A011900 6A011904 826920080
description	thermocouple SIT M9x1 L 850mm plug connection ø6.0(6.5)mm		
For models:	110-135CGG, 110-135CGG2P, 110-135CGGE, 110-135CGGE2P, 110-135CGGEP, 110-135CGGP, 110-90CGG, 110-90CGG1P, 110-90CGGP, 110-90CTG, 110-90CTGE, 110-90CTGG, 110-90FTTG, 110-90FTTG1-2R, 110-90FTTGE, 110-90FTTGG, 110-90FTTGR, 110-90TCTG, 110-90TFTTGR, 2FX+PCF, 40SGFT, 40SGFT-1825020, 40SGFTC, 40SGFTC-1825025, 40SGFTR, 40SGFTR-1825021, 4FX+PCF, 55-45CPG, 55-90CPG, 60SGFT, 60SGFT1-2R-1825031, 60SGFT1-3R-1825030, 60SGFT-1825030, 60SGFTC, 60SGFTC-1825035, 60SGFTR-1825032, 714CTGV-000190, 714CT-GV-1000170, 714CTGV-1000170, 714CTGV-1000170R, 714CT-GVFE-1000180, 714CTGVFE-1000180, 714CT-GVFE-1000180R, 714TAGV-000190, 714TAGV-1000190, 714TA-GV-1000190R, 716CTG-000195, 716CTGV-000195, 72+2CTGG-12700013, 74+2CTGGAN-12700025...(Other models you can see in the webshop)		

thermocouples with aluminised tip

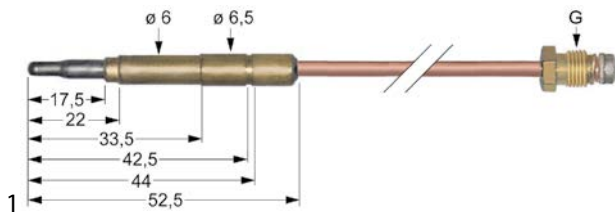

GEV No.	102045	Ref. No.	6A011800 BN6A011800
description	thermocouple M9x1 L 1500mm plug connection ø6.0(6.5)mm		
For models:	2FX+PCF, 4FX+PCF, 72+2CTGG-12700013, 74+2CTGGAN-12700025, 74-02+2CTGG, 74-02+2CTGG-12700030, 74-02CGG, 74-02CGG-12700010, 74-02CGG-12700010TA, 74-02CTGG, 74-02CTGG-12700180, 74-02CTGG-12700180TA, 76-02+4CTGG, 76-02+4CTGG-12700031, 76-02CGFL, 76-02CGFL-12700020, 76-02CGFL-12700020TA, 76-02CGG, 76-02CGG-12700015, 76-02CGG-12700015TA, 76-02CGGE, 76-02CGGE-12700016, 76-02CGGE-12700016TA, 76-02CTGG, 76-02CTGG-12700195, 76-02CTGG-12700195TA, 76-02CTGGE, 76-02CTGGE-12700196, 76-02CTGGE-12700196TA, 796CG-000270, 7PCFL-G120, 94-04KBG, 94-04KBG-12900115, 94-04KBG-12900115TA, 94-04KBG-12900118, 94-04KBG-12900118TA, 94-04KBGM, 94-04KBGM-12900125, 94-04KBGM-12900125TA, 94-04KBGM-12900128, 94-04KBGM-12900128TA, 96-04CGFL, 96-04CGFL-12900019, 96-04CGFL2P, 96-04CGFL2P-12900037, 96-04CGFLP, 96-04CGFLP-12900069, 9BR-G80, 9BR-G81, 9BR-GM80...(Other models you can see in the webshop)		

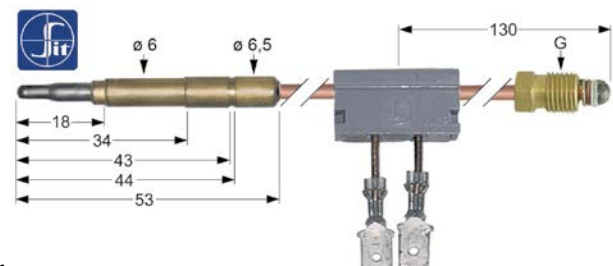

GEV No.	107177	Ref. No.	6A011909 BN6A011909
description	thermocouple SIT with interrupter M9x1 L 600mm plug connection ø6.0mm F 6.3mm		
For models:	40SGFR2S-1826160, 55-45FRG, 55-90FRG, 60SGFR2S-1826170, 72-02FRG-12700500, 72-02FRG17-12700505, 72-02FRGM, 72-02FRGM-12700530, 72-02FRGM-12700530TA, 73-02FRG-12700550, 73-02FRGM, 73-02FRGM-12700580, 73-02FRGM-12700580TA, 74-02FRG-12700600, 74-02FRG17-12700605, 74-02FRGM, 74-02FRGM-12700630, 7FT-G400, 7FT-G410, 7FT-G800, 7FT-G810, 7FT-G820, 7FTTF-G800, 7FTTF-G805, 7FTTF-G820, 7FTTF-G825, 7FTTF-GE800, 7FTTF-GE805, 7FTTF-GE820, 7FTTF-GE825, 7FTT-G400, 7FTT-G405, 7FTT-G410, 7FTT-G415, 7FTT-G800, 7FTT-G805, 7FTT-G810, 7FTT-G815, 7FTT-G820, 7FTT-G825, 7FTTV-G400, 7FTTV-G405, 7FTTV-G410, 7FTTV-G415, 7FTTV-G800, 7FTTV-G805, 7FTTV-G810, 7FTTV-G815, 7FTTV-G820, 7FTTV-G825...(Other models you can see in the webshop)		

plug-in thermocouples with interruption

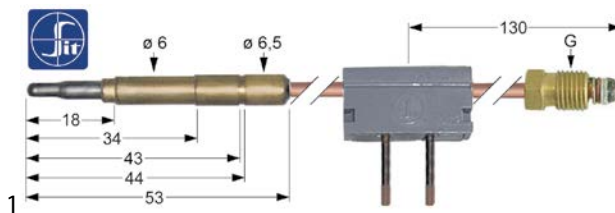

GEV No.	107164	Ref. No.	6A011910 BN6A011910 CR0843660
description	thermocouple SIT with interrupter M9x1 L 1000mm plug connection ø6.0(6.5)mm soldering connection		
For models:	74-02NPGI, 74-02NPGI-12700755, 7FRI-G415, 7FRI-G610, 7FRI-G815, 7NP-GI50, 910PGB-1191800, 911PGB-1191805, 911RPGB-1391830, 92-04FRG15L, 92-04FRG15L-12900510, 92-04FRG17L-12900515, 92-04FRG20L, 92-04FRG20L-12900500, 92-04FRG20L-12900500TA, 93-04FRG, 93-04FRG-12900550, 93-04FRG-12900550H, 94-04FRG-12900600, 94-04FRG20L, 94-04FRG20L-12900600TA, 94-04FRG23L-12900605, 9FRI-G415, 9FRI-G610, 9FRI-G815		

threaded thermocouples

threaded thermocouples standard

with socket with thread M8x1

SIT

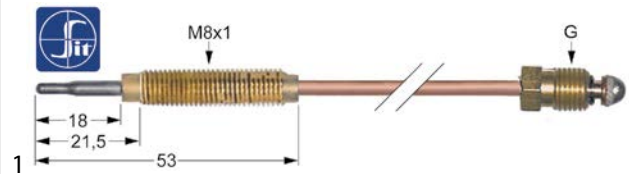

GEV No.	107633	Ref. No.	1665000
description	thermocouple SIT M8x1 L 1200mm M8x1		
For models:	CFG101, CFG120, CFG70, OCFG101, OCFG-101-12600025, OCFG120, OCFG70, OCFG-70-12600000, OPGC-41-12600010		
accessories for	107633		
	GEV No.	102067	Ref. No.
			6A012300 939300 BN6A012300
	nut thread M8x1 H 3mm brass Qty 1 pcs type SEF 1		

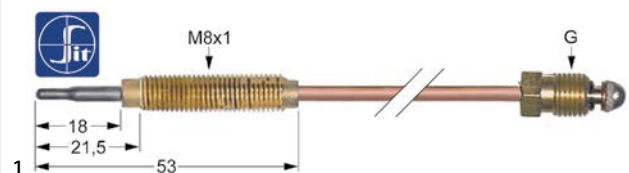

GEV No.	107630	Ref. No.	MA1033027200
description	thermocouple SIT M8x1 L 600mm M8x1		
accessories for	107630		
	GEV No.	102067	Ref. No.
			6A012300 939300 BN6A012300
	nut thread M8x1 H 3mm brass Qty 1 pcs type SEF 1		



GEV No.	107635	Ref. No.	6A015900 BN6A015900
description	thermocouple SIT M9x1 L 320mm M8x1		
accessories for	107635		
	GEV No.	102067	Ref. No.
			6A012300 939300 BN6A012300
	nut thread M8x1 H 3mm brass Qty 1 pcs type SEF 1		

GEV No.	107636	Ref. No.	6A012000 BN6A012000
description	thermocouple SIT M9x1 L 600mm M8x1		
accessories for	107636		
	GEV No.	102067	Ref. No.
			6A012300 939300 BN6A012300
	nut thread M8x1 H 3mm brass Qty 1 pcs type SEF 1		

type Junkers with aluminised tip

GEV No.	102056	Ref. No.	BN6A011905
description	thermocouple M8x1 L 600mm M8x1		
accessories for	102056		
	GEV No.	102067	Ref. No.
			6A012300 939300 BN6A012300
	nut thread M8x1 H 3mm brass Qty 1 pcs type SEF 1		

accessories

nuts

GEV No.	102067	Ref. No.	6A012300 939300 BN6A012300
description	nut thread M8x1 H 3mm brass Qty 1 pcs type SEF 1		
For models:	CFG101, CFG120, CFG70, OCFG101, OCFG-101-12600025, OCFG120, OCFG70, OCFG-70-12600000, OPG-41-12600010		

screws

GEV No.	101260	Ref. No.	1359100
description	thermocouple fitting thread M8x1 Qty 1 pcs		
For models:	OPLG40, OPLG-40-12600850, OPLG80, OPLG-80-12600855, PLG40, PLG80		

interrupters

GEV No.	101265	Ref. No.	1533400 6A013603 9000158
description	interrupter thread M9x1		
For models:	710FRG-077300, 710FRG-1077300, 710FR-G-1077350, 710FR-G-1077350R, 712FRG-077500, 712FR-G-1077550, 712FRG-1077550, 712FR-G-1077550R, 720FRG-077400, 720FRG-1077400, 720FR-G-1077450, 720FRG-1077450, 720FR-G-1077450R, 720FR-G-1077650, 722FRG-077600, 722FRG-1077600, 722FR-G-1077650R, 912PFRG-1103925, 914PFRG-1103950, 922FRE-1192930, 92FRG-1191925, 94FRG-1191950, 94RFRG-1391950, FQG40, FQG60, FR-G925N-1050731, FR-G950N-1050733		

gas burners

bar burners

bar burners

GEV No.	104244	Ref. No.	2708514 MA2708514
description	bar burner ø 50mm Wmm Hmm L 410mm flange width 52mm flange ø 75mm kettle		

2 gas components



			
GEV No.	105777 ¹	Ref. No.	3104830 BN3104830
description	bar burner ø 50mm Wmm Hmm L 440mm with bolt M5x25 flange width 57mm flange length 57mm combi-steamer		
For models:	CV10G, CV10G-1310100, CV10G-2, CV10G2-1310140, CV10GB-1311100, CV10G-S, CV10GS-1310150, CV10G-S2, CV10GS2-1310190, CV6G, CV6G-1310000, CV6G-1310010, CV6G-2, CV6G2-1310040, CV6GB-1311000, CV6G-S, CV6GS-1310050, CV6G-S2, CV6GS2-1310090, CVM10G, CVM10G-1310400, CVM10G-1310410, CVM10G-1310430, CVM10G-1310450, CVM10G-2, CVM10G2-1310440, CVM10GP-1310400, CVM10G-S, CVM10GS-1310460, CVM10G-S2, CVM10GS2-1310490, CVM10GS2-1310495, CVM6G, CVM6G-1310300, CVM6G-1310310, CVM6G-2, CVM6G2-1310340, CVM6G-S, CVM6GS-1310350, CVM6GS-1310360, CVM6G-S2, CVM6GS2-1310390, CVM6GS2-1310395, CVP10G, CVP10G-1310700, CVP10G-1310750, CVP10G-2, CVP10G2-1310740, CVP10GP-1310700, CVP10G-S...(Other models you can see in the webshop)		

¹for ovens with 6+10 grids

			
GEV No.	105779 ¹	Ref. No.	3104840 BN3104840
description	bar burner ø 50mm Wmm Hmm L 440mm with bolt M5x25 flange width 57mm flange length 57mm gas range		
For models:	CV21G, CV21G-1312100, CV21G-2, CV21G2-1312140, CV21G-S, CV21GS-1312150, CV21G-S2, CV21GS2-1312190, CVM21G, CVM21G-1312400, CVM21G-2, CVM21G2-1312440, CVM21G-S, CVM21GS-1312450, CVM21G-S2, CVM21GS2-1312490, CVM21GS2-1312495, CVP21G, CVP21G-1312700, CVP21G-2, CVP21G2-1312740, CVP21G-S, CVP21GS-1312750, CVP21G-S2, CVP21GS2-1312790, ECV21G, ECV21G2-1314490, ECV21GS2-1316160, ECV21GS2, ECV21GS2-1314890, ECV21GS2-1316240, FC21G-2-418035412140, FC21G-2S-418035412190, FC21G-B-418035412100, FC21G-S-418035412150, FCM21G-2-418035412440, FCM21G-2S-418035412490, FCM21G-418035412400, FCM21G-S-418035412450, FCV21G-2-418035412740, FCV21G-2S-418035412790, FCV21G-418035412700, FCV21G-S-418035412750, NECV-M21GS2, NECV21GS2-1317490, NECV21GS2-1318160, NECV21GS2, NECV21GS2-1317890, NECV21GS2-1318240, NFCV21G-PS2-418035417890...(Other models you can see in the webshop)		

¹for ovens with 20 grids

			
GEV No.	105778	Ref. No.	3104850 BN3104850
description	bar burner ø 50mm Wmm Hmm L 600mm flange width 57mm flange length 57mm convection oven		
For models:	CV20G, CV20G-1310200, CV20G-2, CV20G2-1310240, CV20GB-1311200, CV20G-S, CV20GS-1310250, CV20G-S2, CV20GS2-1310290, CVM20G, CVM20G-1310500, CVM20G-2, CVM20G2-1310540, CVM20G-S, CVM20GS-1310550, CVM20G-S2, CVM20GS2-1310590, CVP20G, CVP20G-1310800, CVP20G-1310850, CVP20G-2, CVP20G-S, CVP20GS-1310840, CVP20G-S2, CVP20GS2-1310890, ECV20G, ECV20G2-1314390, ECV20GS2-1316140, ECV20GS2, ECV20GS2-1314790, ECV20GS2-1316220, FC20G-2-418035410240, FC20G-2S-418035410290, FC20G-418035410200, FC20G-S-418035410250, FCM20G-2-418035410540, FCM20G-2S-418035410590, FCM20G-418035410500, FCM20G-S-418035410550, FCV20G-2-418035410840, FCV20G-2S-418035410890, FCV20G-418035410800, FCV20G-S-418035410850, NECV-M20GS2, NECV20GS2-1317390, NECV20GS2-1318140, NECV20GS2, NECV20GS2-1317790, NECV20GS2-1318220, NFCV20G-PS2-418035417790...(Other models you can see in the webshop)		

forced air burners

			
GEV No.	104314	Ref. No.	R63140060
description	gasket L 108mm W 103mm H 3mm 6 holes		
For models:	CKGP10B, CKGP20B, CKGP21B, CKGP40B, CKGT10B, CKGT20B, CKGT21B, CKGT40B		

			
GEV No.	108149	Ref. No.	LA63120030 LAR63120020 LAR63120030 LAR63120040
description	venturi for combi-steamer LAINOX		
For models:	CCG051M, CCG071M, CCG101M, CCG102M, CKGP06, CKGP06B, CKGP10, CKGP10B, CKGP20, CKGP20B, CKGP21, CKGP21B, CKGP40, CKGP40B, CKGT06, CKGT06B, CKGT10, CKGT10B, CKGT20, CKGT20B, CKGT21, CKGT21B, CKGT40, CKGT40B		



pilot burner nozzles SIT

100 series



GEV No.	100245	Ref. No.	1415100 6A013101 MA1415100
description	pilot burner nozzle LPG code 20 bore \varnothing 0.2mm Qty 1 pcs thread M8x0.75		
For models:	110-135CG, 110-135CG2P, 110-135CGE, 110-135CGE2P, 110-135CGEE, 110-135CGEE2P, 110-135CGEEP, 110-135CGEP, 110-135CGG, 110-135CGG2P, 110-135CGGE, 110-135CGGE2P, 110-135CGGEP, 110-135CGGP, 110-135CGP, 110-135TCG, 110-135TCG2P, 110-135TCGP, 110-45CG, 110-45CG1P, 110-45CGP, 110-45TCG, 110-45TCG1P, 110-45TCGP, 110-90CG, 110-90CG1P, 110-90CGE, 110-90CGE1P, 110-90CGEP, 110-90CGG, 110-90CGG1P, 110-90CGGP, 110-90CGP, 110-90TCG, 110-90TCG1P, 110-90TCGP, 4FX, 4FX+PCF, 72-02CG, 72-02TCG, 722FRG-1077600, 74-02+2CTGG, 74-02+2CTGG-12700030, 74-02CG, 74-02CGE, 74-02CGG, 74-02TCG, 76-02CG, 76-02CGE, 76-02CGEE... (Other models you can see in the webshop)		

140/150 series



GEV No.	100204	Ref. No.	1888000 6A013109 MA1888000
description	pilot burner nozzle SIT LPG code 14 bore \varnothing 0.18/0.20mm Qty 1 pcs suitable for 140 series		
For models:	CFG120, OCFG120, OPLG40, OPLG40-12600850, OPLG80, OPLG80-12600855, PLG40, PLG80		



GEV No.	100205	Ref. No.	1033722000 22140380 822140380 BN822140380
description	pilot burner nozzle SIT LPG code 19 bore \varnothing 0.23/0.26mm Qty 1 pcs suitable for SIT 150 series		
For models:	7FT-G400, 7FT-G410, 7FT-G800, 7FT-G810, 7FT-G820, 7FTTF-G800, 7FTTF-G805, 7FTTF-G820, 7FTTF-G825, 7FTTF-GE800, 7FTTF-GE805, 7FTTF-GE820, 7FTTF-GE825, 7FTT-G400, 7FTT-G405, 7FTT-G410, 7FTT-G415, 7FTT-G800, 7FTT-G805, 7FTT-G806, 7FTT-G810, 7FTT-G815, 7FTT-G820, 7FTT-G825, 7FTTV-G400, 7FTTV-G405, 7FTTV-G410, 7FTTV-G415, 7FTTV-G800, 7FTTV-G805, 7FTTV-G810, 7FTTV-G815, 7FTTV-G820, 7FTTV-G825, 7FTV-G400, 7FTV-G410, 7FTV-G800, 7FTV-G810, 7FTV-G820, 7PCF-G120, 7PCF-G121, 7PCF-G160, 7PCF-G161, 7PCF-G800, 7PCF-G811, 7PCF-GE120, 7PCF-GE121, 7PCF-GE160, 7PCF-GE161, 7PCF-GE411... (Other models you can see in the webshop)		



GEV No.	100207	Ref. No.	1887800 6A013107 MA1887800
description	pilot burner nozzle SIT natural gas code 27 bore \varnothing 0.40/0.38mm suitable for SIT 140 series		
For models:	7741C-GVGAS-1950266, 7742C-GV-1950267, 7961C-GVGAS-1950276, 7962C-GV-1950277, 7FT-G400, 7FT-G410, 7FT-G800, 7FT-G810, 7FT-G820, 7FTTF-G800, 7FTTF-G805, 7FTTF-GE820, 7FTTF-GE825, 7FTT-G400, 7FTT-G405, 7FTT-G410, 7FTT-G415, 7FTT-G800, 7FTT-G805, 7FTT-G806, 7FTT-G810, 7FTT-G815, 7FTT-G820, 7FTT-G825, 7FTTV-G400, 7FTTV-G405, 7FTTV-G410, 7FTTV-G415, 7FTTV-G800, 7FTTV-G805, 7FTTV-G810, 7FTTV-G815, 7FTTV-G820, 7FTTV-G825, 7FTV-G400, 7FTV-G410, 7FTV-G800, 7FTV-G810, 7FTV-G820, 7PCF-G120, 7PCF-G121, 7PCF-G160, 7PCF-G161, 7PCF-G800, 7PCF-G811, 7PCF-GE120... (Other models you can see in the webshop)		

160 series



GEV No.	107649	Ref. No.	1033719600
description	pilot burner nozzle SIT LPG code 20 Qty 1 pcs		
For models:	CFG101, CFG70, CFGE61, CFGE61D, CFGE61L, CFGE61P, FQG41, FQG61, OCFG101, OCFG-101-12600025, OCFG70, OCFG-70-12600000, OCFGE61, OFQG41, OFQG-41-12600500, OFQG61, OFQG-61-12600600, OPCG41, OPCG-41-12600010, OPCG61		



GEV No.	107172	Ref. No.	1874700 BN822140370
description	pilot burner nozzle SIT LPG code 25 Qty 1 pcs		
For models:	FQG41, FQG61, OFQG41, OFQG-41-12600500, OFQG61, OFQG-61-12600600		



GEV No.	107174	Ref. No.	1033719700
description	pilot burner nozzle SIT natural gas code 41 Qty 1 pcs		
For models:	CFG101, CFG70, CFGE61, CFGE61D, CFGE61L, CFGE61P, FQG41, FQG61, OCFG101, OCFG-101-12600025, OCFG70, OCFG-70-12600000, OCFGE61, OFQG41, OFQG-41-12600500, OFQG61, OFQG-61-12600600, OPCG41, OPCG-41-12600010, OPCG61		







 <p>1</p>			
GEV No.	107175	Ref. No.	BN822140350
description	pilot burner nozzle SIT natural gas code 51 Qty 1 pcs suitable for 160 series		



screw connections



olives

 <p>1</p>											
GEV No.	101278	Ref. No.	6A011480 86720 BN6A011480 MA86720								
description	olive for pipe ø 10mm Qty 1 pcs										
For models:	110-135CG, 110-135CG2P, 110-135CGE, 110-135CGE2P, 110-135CGEE, 110-135CGEE2P, 110-135CGEEP, 110-135CGEP, 110-135CGG, 110-135CGG2P, 110-135CGGE, 110-135CGGE2P, 110-135CGGEP, 110-135CGGP, 110-135CGP, 110-135TCG, 110-135TCG2P, 110-135TCGP, 110-45CBG, 110-45CG, 110-45CG1P, 110-45CGP, 110-45TCBG, 110-45TCG, 110-45TCG1P, 110-45TCGP, 110-90CG, 110-90CG1P, 110-90CGE, 110-90CGE1P, 110-90CGEP, 110-90CGG, 110-90CGG1P, 110-90CGGP, 110-90CGP, 110-90CTG, 110-90CTGE, 110-90CTGG, 110-90CTG, 110-90CTG1P, 110-90CTGP, 110-90CTGT, 2FX+PCF, 4FX, 4FX+PCF, 55-45CPG, 55-90CPG, 72+2CTGG-12700013, 72-02CBG-12700150, 72-02CG...(Other models you can see in the webshop)										
accessories for	101278										
 <table border="1"> <tr> <td>GEV No.</td> <td>100943</td> <td>Ref. No.</td> <td>—</td> </tr> <tr> <td colspan="4">union nut thread M17x1 tube ø 10mm</td> </tr> </table>				GEV No.	100943	Ref. No.	—	union nut thread M17x1 tube ø 10mm			
GEV No.	100943	Ref. No.	—								
union nut thread M17x1 tube ø 10mm											
 <table border="1"> <tr> <td>GEV No.</td> <td>101300</td> <td>Ref. No.</td> <td>1326500 6A011485 A011485 BN6A011485</td> </tr> <tr> <td colspan="4">union nut thread M16x1.5 tube ø 10mm</td> </tr> </table>				GEV No.	101300	Ref. No.	1326500 6A011485 A011485 BN6A011485	union nut thread M16x1.5 tube ø 10mm			
GEV No.	101300	Ref. No.	1326500 6A011485 A011485 BN6A011485								
union nut thread M16x1.5 tube ø 10mm											
 <table border="1"> <tr> <td>GEV No.</td> <td>101478</td> <td>Ref. No.</td> <td>1665200</td> </tr> <tr> <td colspan="4">union nut thread 3/8" for pipe ø 10mm</td> </tr> </table>				GEV No.	101478	Ref. No.	1665200	union nut thread 3/8" for pipe ø 10mm			
GEV No.	101478	Ref. No.	1665200								
union nut thread 3/8" for pipe ø 10mm											

 <p>1</p>			
GEV No.	106638	Ref. No.	6A016300 BN6A016300
description	olive for pipe ø 12mm L 10mm Qty 1 pcs		
For models:	110-90FTTG, 110-90FTTG1-2R, 110-90FTTGC, 110-90FTTGC1-2R, 110-90FTTGCR, 110-90FTTGE, 110-90FTTGG, 110-90FTTGR, 110-90FTTTG, 110-90FTTTG1-2R, 110-90FTTTGC, 110-90FTTTGC1-2R, 110-90FTTTGCR, 110-90FTTTGR, 2FX+PCF, 31FOGV-1950001, 31FOGV-1950002, 31FOGVG-1000003, 31FOGVM-1000007, 32FOGV2-1000002, 32FOGVG-1000004, 32FOGVM-1000015, 40SECP-1825080, 40SECP-1825080E, 40SGFR-1826160, 40SGFR2S-1826160, 40SGFT-1825020, 40SGFTC-1825025, 40SGFTR-1825021, 4FX+PCF, 55-45FRG, 55-90FRG, 60SGFR-1826170, 60SGFR2S-1826170, 60SGFT1-2R-1825031, 60SGFT-1825030, 60SGFTC-1825035, 60SGFTR-1825032, 710FR-G-1077350, 710FR-G-1077350R, 712FR-G-1077550, 712FR-G-1077550R, 714CT-GV-1000170, 714CT-GV-1000170R, 72+2CTGG-12700013, 72-02FRG, 72-02FRG-12700500, 72-02FRG17-12700505, 72-02FRGM, 72-02FRGM-12700530...(Other models you can see in the webshop)		

 <p>1</p>											
GEV No.	101273	Ref. No.	417810 6A011625 MA417810								
description	olive for pipe ø 12mm L 9.5mm brass Qty 1 pcs suitable for universal										
For models:	110-90FTTG, 110-90FTTG1-2R, 110-90FTTGC, 110-90FTTGC1-2R, 110-90FTTGCR, 110-90FTTGE, 110-90FTTGG, 110-90FTTGR, 110-90FTTTG, 110-90FTTTG1-2R, 110-90FTTTGC, 110-90FTTTGC1-2R, 110-90FTTTGCR, 110-90FTTTGR, 2FX+PCF, 40SGFR-1826160, 40SGFR2S-1826160, 40SGFT-1825020, 40SGFTC-1825025, 40SGFTR-1825021, 4FX+PCF, 55-45FRG, 55-90FRG, 60SGFR-1826170, 60SGFR2S-1826170, 60SGFT1-2R-1825031, 60SGFT-1825030, 60SGFTC-1825035, 60SGFTR-1825032, 72+2CTGG-12700013, 72-02FRG, 72-02FRG-12700500, 72-02FRG17-12700505, 72-02FTG, 72-02FTG-12700130TA, 72-02FTG-12700300, 72-02FTG-12700300TA, 72-02FTGC-12700135, 72-02FTGC-12700135TA, 72-02FTGCVAL, 72-02FTGR, 72-02FTGR-12700132TA, 72-02FTGR-12700302, 72-02FTGR-12700302TA, 72-02FTGRVAL, 72-02FTGVAL, 72-02FTTG-12700130, 72-02FTTGR-12700132, 72-02FTTG, 72-02FTTG-12730130...(Other models you can see in the webshop)										
accessories for	101273										
 <table border="1"> <tr> <td>GEV No.</td> <td>100944</td> <td>Ref. No.</td> <td>—</td> </tr> <tr> <td colspan="4">union nut thread M18x1.5 for pipe ø 12mm</td> </tr> </table>				GEV No.	100944	Ref. No.	—	union nut thread M18x1.5 for pipe ø 12mm			
GEV No.	100944	Ref. No.	—								
union nut thread M18x1.5 for pipe ø 12mm											
 <table border="1"> <tr> <td>GEV No.</td> <td>101276</td> <td>Ref. No.</td> <td>459300 6A011620 A011620</td> </tr> <tr> <td colspan="4">union screw thread 3/8" tube ø 12mm Qty 1 pcs</td> </tr> </table>				GEV No.	101276	Ref. No.	459300 6A011620 A011620	union screw thread 3/8" tube ø 12mm Qty 1 pcs			
GEV No.	101276	Ref. No.	459300 6A011620 A011620								
union screw thread 3/8" tube ø 12mm Qty 1 pcs											



 <p>1</p>											
GEV No.	101256	Ref. No.	6A016500								
description	olive for pipe ø 16mm Qty 1 pcs										
accessories for	101256										
 <table border="1"> <tr> <td>GEV No.</td> <td>101253</td> <td>Ref. No.</td> <td>6A016401</td> </tr> <tr> <td colspan="4">union nut thread M24x1.5 PEL for pipe ø 16mm</td> </tr> </table>				GEV No.	101253	Ref. No.	6A016401	union nut thread M24x1.5 PEL for pipe ø 16mm			
GEV No.	101253	Ref. No.	6A016401								
union nut thread M24x1.5 PEL for pipe ø 16mm											



 <p>1</p>											
GEV No.	101282	Ref. No.	469000								
description	olive for pipe ø 4mm L 7.4mm Qty 1 pcs										
For models:	FQG40, FQG60, FTG40B, FTG40BLC, FTG60B, FTG60BLC, FTG60BR, FTG80B, FTG80BR, OFTG40B, OFTG40BLC, OFTG60B, OFTG60BLC, OFTG60BR, OFTG80B, OFTG80BR										
accessories for	101282										
 <table border="1"> <tr> <td>GEV No.</td> <td>100908</td> <td>Ref. No.</td> <td>673500 6A016110 6A017000 A016110 A017000 BN6A016110 BN6A017000 MA673500</td> </tr> <tr> <td colspan="4">union screw thread M10x1 for pipe ø 4mm Qty 1 pcs</td> </tr> </table>				GEV No.	100908	Ref. No.	673500 6A016110 6A017000 A016110 A017000 BN6A016110 BN6A017000 MA673500	union screw thread M10x1 for pipe ø 4mm Qty 1 pcs			
GEV No.	100908	Ref. No.	673500 6A016110 6A017000 A016110 A017000 BN6A016110 BN6A017000 MA673500								
union screw thread M10x1 for pipe ø 4mm Qty 1 pcs											
 <table border="1"> <tr> <td>GEV No.</td> <td>101283</td> <td>Ref. No.</td> <td>468800</td> </tr> <tr> <td colspan="4">union screw thread M10x1 for pipe ø 4mm Qty 1 pcs</td> </tr> </table>				GEV No.	101283	Ref. No.	468800	union screw thread M10x1 for pipe ø 4mm Qty 1 pcs			
GEV No.	101283	Ref. No.	468800								
union screw thread M10x1 for pipe ø 4mm Qty 1 pcs											

			
1			
GEV No.	101246	Ref. No.	673600 6A016120 MA673600
description	olive for pipe ø 4mm Qty 1 pcs		
For models:	110-45CBG, 110-45TCBG, 2FX+PCF, 4FX, 4FX+PCF, 55-45CPG, 55-90CPG, 72+2CTGG-12700013, 72-02CBG, 72-02CBG-12700150, 72-02CG, 72-02CG-12700001, 72-02CG-12700001TA, 72-02CPG, 72-02CPG-12700900, 72-02FRGM, 72-02FRGM-12700530, 72-02FRGM-12700530TA, 72-02FTG-12700300, 72-02FTG-12700300TA, 72-02FTGR-12700302, 72-02FTGR-12700302TA, 72-02PLG, 72-02PLG-12700850, 72-02PLG-12700850TA, 72-02TCBG, 72-02TCBG-12730150, 72-02TCG, 72-02TCG-12730001, 72-02TCG-12730001TA, 72-02TFTG-12730300, 72-02TFTG-12730300TA, 72-02TFTGR-12730302, 72-02TFTGR-12730302TA, 72-02TFTG-12730302TA, 72-02TGC, 72-02TPLG, 72-02TPLG-12730850, 72-02TPLG-12730850TA, 729CAGV-1950009, 729CAGV-1950009R, 729TCGV-1959009, 729TCGV-1959009R, 73-02FRGM, 73-02FRGM-12700580, 73-02FRGM-12700580TA, 74+2CTGGAN-12700025, 74-02+2CTGG, 74-02+2CTGG-12700030, 74-02CBG, 74-02CBG-12700155...(Other models you can see in the webshop)		
accessories for	101246		
	GEV No.	100908	Ref. No. 673500 6A016110 6A017000 A016110 A017000 BN6A016110 BN6A017000 MA673500
union screw thread M10x1 for pipe ø 4mm Qty 1 pcs			



			
1			
GEV No.	100897	Ref. No.	1881000 1888100 22450050 MA1888100
description	olive for pipe ø 4mm Qty 1 pcs for pilot burner		
For models:	CFG120, OCFG120, OFTG40B, OFTG40B-12600130, OFTG40BLC, OFTG40BLC-12600135, OFTG40BR, OFTG40BR-12600132, OFTG60B, OFTG60B-12600140, OFTG60BLC, OFTG60BLC-12600145, OFTG60BR, OFTG60BR-12600141, OFTG60BRR, OFTG60BRR-12600142, OFTG80BLC, OFTG80BLC-12600138, OPLG40, OPLG40-12600850, OPLG80, OPLG80-12600855, PLG40, PLG80		

			
1			
GEV No.	100870	Ref. No.	BN822450380
description	olive for pipe ø 4mm Qty 1 pcs suitable for 160 series for pilot burner		

			
1			
GEV No.	100898	Ref. No.	41822450470 6A011706 BN41822450470 BN6A011706
description	olive for pipe ø 6mm Qty 1 pcs for pilot burner		
For models:	7741C-GVGAS-1950266, 7742C-GV-1950267, 7961C-GVGAS-1950276, 7962C-GV-1950277		
accessories for	100898		
	GEV No.	100909	Ref. No. LA62060223 LAR62060223
union screw thread M10x1 for pipe ø 6mm Qty 1 pcs			

			
1			
GEV No.	101286	Ref. No.	LA62070023 LAR62070023
description	olive ID ø 6mm Qty 1 pcs		
accessories for	101286		
	GEV No.	100909	Ref. No. LA62060223 LAR62060223
union screw thread M10x1 for pipe ø 6mm Qty 1 pcs			
	GEV No.	101464	Ref. No. —
union nut thread M12x1 for pipe ø 6mm			

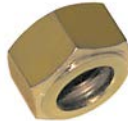
union nuts

			
1			
GEV No.	101253	Ref. No.	6A016401
description	union nut thread M24x1.5 PEL for pipe ø 16mm		
accessories for	101253		
	GEV No.	101256	Ref. No. 6A016500
olive for pipe ø 16mm Qty 1 pcs			

union screws

			
1			
GEV No.	100904	Ref. No.	1394700 6A011608 BN6A011608 MA1394700
description	locking screw M10x1 for pipe ø 4mm Qty 1 pcs		
For models:	110-135CG, 110-135CG2P, 110-135CGE, 110-135CGE2P, 110-135CGEE, 110-135CGEE2P, 110-135CGEEP, 110-135CGEP, 110-135CGG, 110-135CGG2P, 110-135CGGE, 110-135CGGE2P, 110-135CGGER, 110-135CGGP, 110-135CGP, 110-135TCG, 110-135TCG2P, 110-135TCGP, 110-45CG, 110-45CG1P, 110-45CGP, 110-45TCG, 110-45TCG1P, 110-45TCGP, 110-90CG, 110-90CG1P, 110-90CGE, 110-90CGE1P, 110-90CGEP, 110-90CGG, 110-90CGG1P, 110-90CGGP, 110-90CGP, 110-90CTGG, 110-90FTTG, 110-90FTTG1-2R, 110-90FTTGC, 110-90FTTGC1-2R, 110-90FTTGCR, 110-90FTTGE, 110-90FTTGG, 110-90FTTGR, 110-90TCG, 110-90TCG1P, 110-90TCGP, 110-90TFTTG, 110-90TFTTG1-2R, 110-90TFTTGC, 110-90TFTTGC1-2R, 110-90TFTTGR...(Other models you can see in the webshop)		

1

GEV No.	100905	Ref. No.	6A011607 6A011705 BN6A011705
description	locking screw M10x1 for pipe ø6mm Qty 1 pcs		
For models:	7741C-GVGAS-1950266, 7742C-GV-1950267, 7961C-GVGAS-1950276, 7962C-GV-1950277		



1

GEV No.	100906	Ref. No.	1888400 6A011707 MA1888400
description	screw connection thread M10x1 for ignition electrode brass Qty 1 pcs WS 10		
For models:	7FT-G400, 7FT-G410, 7FT-G800, 7FT-G810, 7FT-G820, 7FTTF-G800, 7FTTF-G805, 7FTTF-G820, 7FTTF-G825, 7FTTF-GE800, 7FTTF-GE805, 7FTTF-GE820, 7FTTF-GE825, 7FTT-G400, 7FTT-G405, 7FTT-G410, 7FTT-G415, 7FTT-G800, 7FTT-G805, 7FTT-G810, 7FTT-G815, 7FTT-G820, 7FTT-G825, 7FTTV-G400, 7FTTV-G405, 7FTTV-G410, 7FTTV-G415, 7FTTV-G800, 7FTTV-G805, 7FTTV-G810, 7FTTV-G815, 7FTTV-G820, 7FTTV-G825, 7FTV-G400, 7FTV-G410, 7FTV-G800, 7FTV-G810, 7FTV-G820, 7PCF-G120, 7PCF-G121, 7PCF-G160, 7PCF-G161, 7PCF-G800, 7PCF-G811, 7PCF-GE121, 7PCF-GE161, 7PCF-GE411, 7PC-G121, 7PC-G161, 7PC-G411...(Other models you can see in the webshop)		







1

GEV No.	100907	Ref. No.	1891700
description	screw connection thread M10x1 Qty 1 pcs type SEF 1 ømm for thermocouple		
For models:	CFG120, OCFG120, OFTG40B, OFTG-40B-12600130, OFTG40BLC, OFTG-40BLC-12600135, OFTG40BR, OFTG-40BR-12600132, OFTG60B, OFTG-60B-12600140, OFTG60BLC, OFTG-60BLC-12600145, OFTG-60BR, OFTG-60BR-12600141, OFTG60BRR, OFTG-60BRR-12600142, OFTG80BLC, OFTG-80BLC-12600138		







1

GEV No.	100908	Ref. No.	673500 6A016110 6A017000 BN6A016110 BN6A017000 MA673500
description	union screw thread M10x1 for pipe ø4mm Qty 1 pcs		
For models:	110-135CGG, 110-135CGG2P, 110-135CGGE, 110-135CGGE2P, 110-135CGGEP, 110-135CGGP, 110-45CBG, 110-45TCBG, 110-90CGG, 110-90CGG1P, 110-90CGGP, 110-90CTG, 110-90CTGE, 110-90CTGG, 110-90FTTG, 110-90FTTG1-2R, 110-90FTTGC, 110-90FTTGC1-2R, 110-90FTTGCR, 110-90FTTGE, 110-90FTTGG, 110-90FTTGR, 110-90TCTG, 110-90FTTG, 110-90FTTG1-2R, 110-90FTTGC, 110-90FTTGC1-2R, 110-90FTTGC, 110-90FTTGC1-2R, 110-90FTTGC, 110-90FTTGR, 2FX+PCF, 40SGFR-1826160, 40SGFR2S-1826160, 40SGFT-1825020, 40SGFTC-1825025, 40SG-FTR-1825021, 4FX, 4FX+PCF, 55-45CPG, 55-45FRG, 55-90CPG, 55-90FRG, 60SGFR-1826170, 60SGFR2S-1826170, 60SGFT1-2R-1825031, 60SGFT-1825030, 60SGFTC-1825035, 60SGFTR-1825032, 72+2CTGG-12700013, 72-02CBG, 72-02CBG-12700150...(Other models you can see in the webshop)		
accessories for	100908		
	GEV No.	100897	Ref. No. 1881000 1888100 22450050 MA1888100
olive for pipe ø4mm Qty 1 pcs for pilot burner			
	GEV No.	101246	Ref. No. 673600 6A016120 A016120 MA673600
olive for pipe ø4mm Qty 1 pcs			
	GEV No.	101280	Ref. No. —
olive for pipe ø4mm Qty 1 pcs			
	GEV No.	101282	Ref. No. 469000
olive for pipe ø4mm L 7.4mm Qty 1 pcs			



1

GEV No.	100909	Ref. No.	LA62060223 LAR62060223
description	union screw thread M10x1 for pipe ø6mm Qty 1 pcs		
accessories for	100909		
	GEV No.	100898	Ref. No. 41822450470 6A011706 A011706 BN41822450470 BN6A011706
olive for pipe ø6mm Qty 1 pcs for pilot burner			
	GEV No.	101286	Ref. No. LA62070023 LAR62070023
olive ID ø6mm Qty 1 pcs			
	GEV No.	101287	Ref. No. —
olive for pipe ø6mm Qty 1 pcs			
	GEV No.	101288	Ref. No. —
olive for pipe ø6mm L 6mm aluminium Qty 1 pcs ED ø 8.5mm			



pressure switches

			
1			
GEV No.	541073	Ref. No.	LA63070010 LAR63070010
description	pressure control ø 45mm pressure range adjustable 5-20mbar pressure connection vertical gas technology connection 1/4" pressure connection ø 1/4"mm		
For models:	CCG051M, CCG071M, CCG101M, CCG102M, CKGP06, CKGP06B, CKGP10, CKGP10B, CKGP20, CKGP20B, CKGP21, CKGP21B, CKGP40, CKGP40B, CKGT06, CKGT06B, CKGT10, CKGT10B, CKGT20, CKGT20B, CKGT21, CKGT21B, CKGT40, CKGT40B		

consumables

thread sealants

			
1			
GEV No.	890097	Ref. No.	Loctite 577
description	thread sealing LOCTITE 577 medium-strength bottle 50ml pipe thread sealing t.max. 150°C approval BAM and DVGW		
description	<p>LOCTITE® 577™ - bottle 50ml</p> <p>It is designed for the locking and sealing of metal pipes and fittings as well as other cylindrical metal assemblies. The product provides an instant, low-pressure seal for metal pipes and fittings. It will not creep, shrink or block systems by shredding. Suitable for fast application at low temperatures. It has excellent chemical and thermal resistance and offers less migration of liquid product after application to the part.</p>		
For models:	OLAX151, OLAX151EDX-1080725, OLAX151ELEFT-1080727, OLAX151-highspeed, OLAX160, OLAX160E-1080750, OLAX160E-1080751, OLAX160V-1080755, OLAX160V-1080756, OLAX160V-1081031, OLAX160V-1081032, OLAX210, OLAX210E-1081029, OLAX210E-1081030, OLAX220, OLAX220E-1080787, OLAX220E-1080788, OLAX220V-1080789, OLAX220V-1080790, OLAX230, OLAX230E-1080791, OLAX230E-1080792, OLAX230V-1080793, OLAX230V-1080794, OLAX240, OLAX240E-1080795, OLAX240E-1080796, OLAX240V-1080797, OLAX240V-1080798, OLAX250, OLAX250E-1080760, OLAX250E-1080761, OLAX250V-1080765, OLAX250V-1080766, OLAX300, OLAX300E-1080770, OLAX300E-1080771, OLAX300E-1081033, OLAX300E-1081035, OLAX300E-1081036, OLAX300LC, OLAX300LCE-1081034, OLAX300V-1080775, OLAX300V-1080776, OLAX310, OLAX310E-1081110, OLAX310E-1081111, OLAX310LC, OLAX310LCE-1081114, OLAX310LCE-1081115...(Other models you can see in the webshop)		

equipmentspecific units

for convection ovens/combi-steamers

drain units

drip rails

			
1			
GEV No.	691961	Ref. No.	LA69180010 LAR69180010 R69180000
description	drain unit L 90mm edition since 2009		
For models:	CKEP06, CKEP06B, CKEP10, CKEP10B, CKEP20, CKEP20B, CKET06, CKET06B, CKET10, CKET10B, CKET20, CKET20B, CKGP06, CKGP06B, CKGP10, CKGP10B, CKGP20, CKGP20B, CKGT06, CKGT06B, CKGT10, CKGT10B, CKGT20B		

			
1			
GEV No.	698946	Ref. No.	LAR69180220
description	drip rail L 557mm plastic W 33.5mm		

			
1			
GEV No.	698947	Ref. No.	LAR69180230
description	drip rail L 797mm plastic W 33.5mm		

			
1			
GEV No.	692807	Ref. No.	R69180170
description	drip rail with screw connection L 750mm plastic W 70mm for combi-steamer		
For models:	CKEP20, CKEP20B, CKET20, CKET20B, CKGP20, CKGP20B, CKGT20, CKGT20B		



drain valves



1

GEV No.	694977	Ref. No.	LA62280038
description	drain pipe angled 90° polypropylene DN50 for combi-steamer		

injection nozzles



1

GEV No.	691278	Ref. No.	R58006130
description	injection nozzle bore \varnothing 1mm for combi-steamer		
For models:	CKEP06, CKEP06B, CKEP10, CKEP10B, CKEP20, CKEP20B, CKEP21, CKEP21B, CKEP40, CKEP40B, CKET06, CKET06B, CKET10, CKET10B, CKET20, CKET20B, CKET21, CKET21B, CKET40, CKET40B, CKGP06, CKGP06B, CKGP10, CKGP10B, CKGP20, CKGP20B, CKGP21, CKGP21B, CKGP40, CKGP40B, CKGT06, CKGT06B, CKGT10, CKGT10B, CKGT20, CKGT20B, CKGT21, CKGT21B, CKGT40, CKGT40B		

injection pipes



1

GEV No.	692821	Ref. No.	R18200540
description	injection pipe for combi-steamer H 75mm ED \varnothing 8mm ID \varnothing 6mm L 105mm		
For models:	CCE042M, CCE051M, CCG051M		



1

GEV No.	692832	Ref. No.	R11201990
description	injection pipe for combi-steamer U-shape ED \varnothing 8mm ID \varnothing 6mm		
For models:	CCG101M, CCG102M, CKEP21, CKEP21B, CKEP40, CKEP40B, CKET21, CKET21B, CKET40, CKET40B, CKGP20, CKGP20B, CKGP21, CKGP21B, CKGP40, CKGP40B, CKGT20, CKGT20B, CKGT21, CKGT21B, CKGT40, CKGT40B		



1

GEV No.	692820	Ref. No.	R11200650
description	injection pipe with holder for combi-steamer ED \varnothing 8mm ID \varnothing 6mm L 150mm H 75mm		
For models:	CCE071M, CCG071M, CKEP06, CKEP06B, CKET06, CKET06B, CKGP06, CKGP06B, CKGT06, CKGT06B		

spare parts and accessories



1

GEV No.	692835	Ref. No.	LAR58003110
description	pin for air baffle combi-steamer L 38mm \varnothing 7mm		
For models:	CKEP06, CKEP06B, CKEP10, CKEP10B, CKEP21, CKEP21B, CKET06, CKET06B, CKET10, CKET10B, CKET21, CKET21B, CKGP06, CKGP06B, CKGP10, CKGP10B, CKGP21, CKGP21B, CKGT06, CKGT06B, CKGT10, CKGT10B, CKGT21, CKGT21B		



1

GEV No.	694979	Ref. No.	LA69180110 LAR69180110
description	thermostatic steam trap for combi-steamer plastic		

filters



1

GEV No.	691269	Ref. No.	R18200260
description	drain filter \varnothing 43mm		
For models:	CCE042M		



1

GEV No.	691270	Ref. No.	R10201700
description	drain filter ø 76mm		
For models:	CCE071M, CCG071M, CKEP06, CKEP06B, CKEP10, CKEP10B, CKEP20, CKEP20B, CKEP21, CKEP21B, CKET06, CKET06B, CKET10, CKET10B, CKET20, CKET20B, CKET21, CKET21B, CKGP06, CKGP06B, CKGP10, CKGP10B, CKGP20, CKGP20B, CKGT06, CKGT06B, CKGT10, CKGT10B, CKGT20, CKGT20B		



2

GEV No.	691271	Ref. No.	LA10201710 LAR10201710
description	drain filter ø 87mm		
For models:	CCE101M, CCE102M, CCG101M, CCG102M, CKEP40, CKEP40B, CKET40, CKET40B, CKGP21, CKGP21B, CKGP40, CKGP40B, CKGT21, CKGT21B, CKGT40, CKGT40B		

glass panels

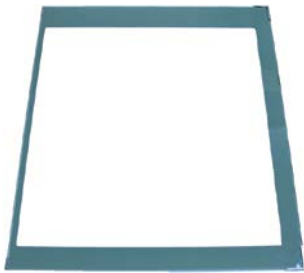

1

GEV No.	696396	Ref. No.	R11100140
description	glass panel L 860mm W 730mm thickness 6mm mounting pos. inner for combi-steamer		
For models:	CKEP20, CKEP20B, CKET20, CKET20B, CKGP20, CKGP20B, CKGT20B		

cleaning system

cleaning arms



1

GEV No.	542409	Ref. No.	LAR58007020
description	mounting flange with gasket for wash arm suitable for LAINOX combi-steamer		
For models:	CKEP06, CKEP06B, CKEP10, CKEP10B, CKEP20, CKEP20B, CKEP21, CKEP21B, CKEP40, CKEP40B, CKET06, CKET06B, CKET10, CKET10B, CKET20, CKET20B, CKET21, CKET21B, CKET40, CKET40B, CKGP06, CKGP06B, CKGP10, CKGP10B, CKGP20, CKGP20B, CKGP21, CKGP21B, CKGP40, CKGP40B, CKGT06, CKGT06B, CKGT10, CKGT10B, CKGT20, CKGT20B, CKGT21, CKGT21B, CKGT40, CKGT40B		

hoses

1

GEV No.	694953	Ref. No.	LA80150040 LAR70070080
description	hose ID ø 13mm ED ø 23mm L 1mm EPDM blue/white t.max. 120°C for combi-steamer		

screw connections



1

GEV No.	542412	Ref. No.	LAR58007000
description	bolt for flange wash arm L 50mm M12x1 suitable for combi-steamer		

pipes



1

GEV No.	520970	Ref. No.	R62180022
description	drain pipe flexible L 135mm ID ø 18mm ED ø 27.5mm connection 3/4" ET - 3/4" IT SS for combi-steamer		
For models:	CKGP06B, CKGP10, CKGP10B, CKGP20B, CKGP21B, CKGP40B, CKGT06B, CKGT10, CKGT10B, CKGT20B, CKGT21B, CKGT40B		

hoses

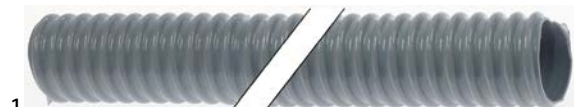

1

GEV No.	530904	Ref. No.	LAR77700056
description	hose ID ø 30mm ED ø 36mm L 3000mm for combi-steamer		
For models:	CCG051M, CCG071M, CCG101M, CCG102M, CKGP06, CKGP06B, CKGP10, CKGP10B, CKGP20, CKGP20B, CKGP21, CKGP21B, CKGP40, CKGP40B, CKGT06, CKGT06B, CKGT10, CKGT10B, CKGT20, CKGT20B, CKGT21, CKGT21B, CKGT40, CKGT40B		



1

GEV No.	520534	Ref. No.	LA70060040 LAR70060040
description	hose ID ø 50mm ED ø 58mm L 50mm silicone Qty 1 for combi-steamer thickness 4mm		
For models:	CKEP06, CKEP06B, CKEP10, CKEP10B, CKEP20, CKEP20B, CKEP21, CKEP21B, CKEP40, CKEP40B, CKET06, CKET06B, CKET10, CKET10B, CKET20, CKET20B, CKET21, CKET21B, CKET40, CKET40B, CKGP06, CKGP06B, CKGP10, CKGP10B, CKGP20, CKGP20B, CKGP21, CKGP21B, CKGP40, CKGP40B, CKGT06, CKGT06B, CKGT10, CKGT10B, CKGT20, CKGT20B, CKGT21, CKGT21B, CKGT40, CKGT40B		



1

GEV No.	530901	Ref. No.	LA70060050 R70060050
description	hose ID ø 54mm ED ø 60mm L 50mm for combi-steamer		
For models:	CKEP20, CKEP20B, CKEP40, CKEP40B, CKET20, CKET20B, CKET40, CKET40B, CKGP40, CKGP40B, CKGT40, CKGT40B		

service kits



1

GEV No.	699468	Ref. No.	R58003100
description	mounting set for air baffle 4-piece		
For models:	CKEP20, CKEP20B, CKEP40, CKEP40B, CKET20, CKET20B, CKET40, CKET40B, CKGP20, CKGP20B, CKGP40, CKGP40B, CKGT20, CKGT20B, CKGT40, CKGT40B		

drip water trays



1

GEV No.	699854	Ref. No.	R69180190
description	drip tray L 520mm W 35mm H 70mm		
For models:	CKEP06, CKEP06B, CKEP10, CKEP10B, CKET06, CKET06B, CKET10, CKET10B, CKGP06, CKGP06B, CKGP10, CKGP10B, CKGT06, CKGT06B, CKGT10, CKGT10B		



1

GEV No.	699242	Ref. No.	R69180200
description	drip tray L 576mm W 32mm H 51mm		
For models:	CKEP06, CKEP06B, CKEP10, CKEP10B, CKET06, CKET06B, CKET10, CKET10B, CKGP06, CKGP06B, CKGP10, CKGP10B, CKGT06, CKGT06B, CKGT10, CKGT10B		

doors



1

GEV No.	697863	Ref. No.	3106355 BN3106355
description	locking screw for oven door		
For models:	CMV6ES2-1320392, CV10E, CV10E-1320100, CV10E-1320110, CV10E-2, CV10E2-1320140, CV10EB-1321100, CV10E-S, CV10ES-1320150, CV10E-S2, CV10ES2-1320190, CV10G, CV10G-1310100, CV10G-2, CV10G2-1310140, CV10GB-1311100, CV10G-S, CV10GS-1310150, CV10G-S2, CV10GS2-1310190, CV20E, CV20E-1320200, CV20E-2, CV20E2-1320240, CV20EB-1321200, CV20E-S, CV20ES-1320250, CV20E-S2, CV20ES2-1320290, CV20G, CV20G-1310200, CV20G-2, CV20G2-1310240, CV20GB-1311200, CV20G-S, CV20GS-1310250, CV20G-S2, CV20GS2-1310290, CV21E, CV21E-1322100, CV21E-2, CV21E2-1322140, CV21E-S, CV21ES-1322150, CV21E-S2, CV21ES2-1322190, CV21G, CV21G-1312100, CV21G-2, CV21G2-1312140...(Other models you can see in the webshop)		



1

GEV No.	691298	Ref. No.	R18100000
description	oven door complete		
For models:	CCE042M		



1

GEV No.	692836	Ref. No.	R11401360
description	protective plate lower for glass plate combi-steamer H 8mm W 8mm		
For models:	CKEP06, CKEP06B, CKEP10, CKEP10B, CKEP20, CKEP20B, CKET06, CKET06B, CKET10, CKET10B, CKET20, CKET20B, CKGP06, CKGP06B, CKGP10, CKGP10B, CKGP20, CKGP20B, CKGT06, CKGT06B, CKGT10, CKGT10B, CKGT20B		

mechanical components, equipment accessories



1

GEV No.	692837	Ref. No.	R11401340
description	protective plate upper for glass plate combi-steamer H 8mm W 8mm		
For models:	CCE071M, CCE101M, CCE102M, CCG071M, CCG101M, CCG102M, CKEP06, CKEP06B, CKEP10, CKEP10B, CKEP20, CKEP20B, CKET06, CKET06B, CKET10, CKET10B, CKET20, CKET20B, CKGP06, CKGP06B, CKGP10, CKGP10B, CKGP20, CKGP20B, CKGT06, CKGT06B, CKGT10, CKGT10B, CKGT20B		

door mechanics

holders



1

GEV No.	691272	Ref. No.	R18203910
description	bracket for glass plate mounting pos. lower		
For models:	CCE071M, CCE101M, CCE102M, CCG071M, CCG101M, CCG102M		



1

GEV No.	691273	Ref. No.	R18203920
description	bracket for glass plate mounting pos. upper		
For models:	CCE071M, CCE101M, CCE102M, CCG071M, CCG101M, CCG102M		

accessories



1

GEV No.	692834	Ref. No.	R10207680
description	fixing plate for door W 30mm L 50mm		
For models:	CKEP21, CKEP21B, CKEP40, CKEP40B, CKET21, CKET21B, CKET40, CKET40B, CKGP21, CKGP21B, CKGP40, CKGP40B, CKGT21, CKGT21B, CKGT40, CKGT40B		

vibration pumps



1

GEV No.	500568	Ref. No.	LAR65110600
description	vibration pump 230V 32W 50Hz inlet ø 7 outlet ø 1/8" IT CEME type E512/A32		

For models:	CKEP06, CKEP06B, CKEP10, CKEP10B, CKEP20, CKEP20B, CKEP21, CKEP21B, CKEP40, CKEP40B, CKET06, CKET06B, CKET10, CKET10B, CKET20, CKET20B, CKET21, CKET21B, CKET40, CKET40B, CKGP06, CKGP06B, CKGP10, CKGP10B, CKGP20, CKGP20B, CKGP21, CKGP21B, CKGP40, CKGP40B, CKGT06, CKGT06B, CKGT10, CKGT10B, CKGT20, CKGT20B, CKGT21, CKGT21B, CKGT40, CKGT40B		
--------------------	--	--	--

spare parts for	500568	GEV No.	390698	Ref. No.	—
------------------------	--------	----------------	--------	-----------------	---



thermal fuse switch-off temp. 110°C suitable for ULKA pump

heat exchangers



1

GEV No.	520509	Ref. No.	LA58004170 LAR58004170
----------------	--------	-----------------	---------------------------

description	reducing washer gas burner brass ID ø 3mm ED ø 16mm thickness 2.2mm code 3		
--------------------	--	--	--

For models:	CCG051M, CCG071M, CKGP06, CKGP06B, CKGT06, CKGT06B		
--------------------	--	--	--

miscellaneous



1

GEV No.	696428	Ref. No.	R11201970
----------------	--------	-----------------	-----------

description	extension U-shape for injection pipe D1 ø 8mm D2 ø 10mm L 212mm WS 12 stainless steel		
--------------------	---	--	--

For models:	CCE101M, CCE102M, CKEP10, CKEP10B, CKEP20, CKEP20B, CKET10, CKET10B, CKET20, CKET20B, CKGP10, CKGP10B, CKGT10, CKGT10B		
--------------------	--	--	--



1

GEV No.	691290	Ref. No.	R10100140
description	extractor stubs complete		
For models:	CKEP06, CKEP06B, CKEP10, CKEP10B, CKEP20, CKEP20B, CKEP21, CKEP21B, CKET06, CKET06B, CKET10, CKET10B, CKET20, CKET20B, CKET21, CKET21B, CKGP06, CKGP06B, CKGP10, CKGP10B, CKGP20, CKGP20B, CKGT06, CKGT06B, CKGT10, CKGT10B, CKGT20, CKGT20B		



1

GEV No.	691282	Ref. No.	R58005350
description	gasket for door handle D1 ø 30mm D2 ø 18mm mounting pos. upper H 1.4mm		
For models:	CCE042M, CCE051M, CCE071M, CCE101M, CCE102M, CCG051M, CCG071M, CCG101M, CCG102M		



1

GEV No.	691291	Ref. No.	R70060020
description	gasket for extractor stubs D1 ø 30mm D2 ø 35mm W 9mm		
For models:	CKEP06, CKEP06B, CKEP10, CKEP10B, CKEP20, CKEP20B, CKEP21, CKEP21B, CKET06, CKET06B, CKET10, CKET10B, CKET20, CKET20B, CKET21, CKET21B, CKGP06, CKGP06B, CKGP10, CKGP10B, CKGP20, CKGP20B, CKGT06, CKGT06B, CKGT10, CKGT10B, CKGT20, CKGT20B		



1

GEV No.	690762	Ref. No.	R69180180
description	gutter for inner door L 790mm plastic W 34mm with screws		
For models:	CKEP20, CKEP20B, CKET20, CKET20B, CKGP20, CKGP20B, CKGT20B		



1

GEV No.	690099	Ref. No.	LA58002150 LAR58002150
description	hinge pin mounting pos. upper for door		
For models:	CCE071M, CCE101M, CCE102M, CCG071M, CCG101M, CCG102M, CKEP06, CKEP06B, CKEP10, CKEP10B, CKEP20, CKEP20B, CKEP21, CKEP21B, CKEP40, CKEP40B, CKET06, CKET06B, CKET10, CKET10B, CKET20, CKET20B, CKET21, CKET21B, CKET40, CKET40B, CKGP06, CKGP06B, CKGP10, CKGP10B, CKGP20, CKGP20B, CKGP21, CKGP21B, CKGP40, CKGP40B, CKGT06, CKGT06B, CKGT10, CKGT10B, CKGT20B, CKGT21, CKGT21B, CKGT40, CKGT40B		



1

GEV No.	696547	Ref. No.	R11202270
description	injection pipe angled for combi-steamer D1 ø 10mm D2 ø 8mm L 170mm		
For models:	CCE071M, CCE101M, CCE102M, CCG071M, CCG101M, CCG102M, CKEP20, CKEP20B, CKEP21, CKEP21B, CKEP40, CKEP40B, CKET20, CKET20B, CKET21, CKET21B, CKET40, CKET40B, CKGP20, CKGP20B, CKGP21, CKGP21B, CKGP40, CKGP40B, CKGT20, CKGT20B, CKGT21, CKGT21B, CKGT40, CKGT40B		



1

GEV No.	506229	Ref. No.	R11200380
description	injection pipe for combi-steamer L 205mm ø 10mm		
For models:	CKEP06, CKEP06B, CKEP10, CKEP10B, CKET06, CKET06B, CKET10, CKET10B, CKGP06, CKGP06B, CKGP10, CKGP10B, CKGT06, CKGT06B, CKGT10, CKGT10B		



1

GEV No.	691289	Ref. No.	R58004830
description	nut thread M18x1 H 5mm WS 22 brass Qty 1 pcs for door handle		
For models:	CCE042M, CCE051M, CCE071M, CCE101M, CCE102M, CCG051M, CCG071M, CCG101M, CCG102M		



1

GEV No.	691296	Ref. No.	R61400052
description	plain washer ID ø 10.5mm ED ø 21mm thickness 2mm SS Qty 1 pcs for fan wheel		
For models:	CCE071M, CCG071M, CKEP06, CKEP06B, CKET06, CKET06B, CKGP06, CKGP06B, CKGT06, CKGT06B		

mechanical components, equipment accessories



1

GEV No.	691292	Ref. No.	R10401710
description	plain washer ID ø 12mm ED ø 17.5mm thickness 1mm SS Qty 1 pcs		
For models:	CCE071M, CCE101M, CCE102M, CCG071M, CCG101M, CCG102M, CKEP06, CKEP06B, CKEP10, CKEP10B, CKEP20, CKEP20B, CKET06, CKET06B, CKET10, CKET10B, CKET20, CKET20B, CKGP06, CKGP06B, CKGP10, CKGP10B, CKGP20, CKGP20B, CKGT06, CKGT06B, CKGT10, CKGT10B, CKGT20B		



1

GEV No.	691283	Ref. No.	R58003240
description	pressure bolt for door handle D1 ø 8mm D2 ø 11mm L 73mm thread M6 bolt 16mm bolt ø 5mm		
For models:	CCE042M, CCE051M, CCE071M, CCE101M, CCE102M, CCG051M, CCG071M, CCG101M, CCG102M		



1

GEV No.	691297	Ref. No.	LA62030113 R62030118
description	reducer thread 1/4 / 1/8		
For models:	CKEP06, CKEP10, CKEP20, CKEP21, CKEP40, CKET06, CKET10, CKET20, CKET21, CKET40, CKGP06, CKGP10, CKGP20, CKGP21, CKGP40, CKGT06, CKGT10, CKGT20, CKGT21, CKGT40		
accessories for	691297		
	GEV No.	529544	Ref. No. —
	O-ring EPDM thickness 2.62mm ID ø 7.59mm Qty 1 pcs		



1

GEV No.	691280	Ref. No.	R58005340
description	sealing disc for door handle mounting pos. lower ED ø 25mm ID ø 5.5mm H 5mm		
For models:	CCE042M, CCE051M, CCE071M, CCE101M, CCE102M, CCG051M, CCG071M, CCG101M, CCG102M		



1

GEV No.	691281	Ref. No.	R58004270
description	spacer piece for door handle L 34mm ID ø 6mm ED ø 8mm		
For models:	CCE042M, CCE051M, CCE071M, CCE101M, CCE102M, CCG051M, CCG071M, CCG101M, CCG102M		



1

GEV No.	692300	Ref. No.	LAR70050100 LAR70050180
description	stopper with screw connection for glass plate D1 ø 15mm L 8mm thread M4		
For models:	CCE071M, CCE101M, CCE102M, CCG071M, CCG101M, CCG102M, CKEP06, CKEP06B, CKEP10, CKEP10B, CKEP20, CKEP20B, CKEP21, CKEP21B, CKEP40, CKEP40B, CKET06, CKET06B, CKET10, CKET10B, CKET20, CKET20B, CKET21, CKET21B, CKET40, CKET40B, CKGP06, CKGP06B, CKGP10, CKGP10B, CKGP20, CKGP20B, CKGP21, CKGP21B, CKGP40, CKGP40B, CKGT06, CKGT06B, CKGT10, CKGT10B, CKGT20B, CKGT21, CKGT21B, CKGT40, CKGT40B		

for dishwashers

miscellaneous



1

GEV No.	506160	Ref. No.	11185 11611
description	plain washer ID ø 8.6mm ED ø 16mm thickness 1.5mm SS Qty 1 pcs		
For models:	OLAX151, OLAX151EDX-1080725, OLAX151LEFT-1080727, OLAX151-highspeed, OLAX160, OLAX160E-1080750, OLAX160E-1080751, OLAX160V-1080755, OLAX160V-1080756, OLAX160V-1081031, OLAX160V-1081032, OLAX210, OLAX210E-1081029, OLAX210E-1081030, OLAX220, OLAX220E-1080787, OLAX220E-1080788, OLAX220V-1080789, OLAX220V-1080790, OLAX230, OLAX230E-1080791, OLAX230E-1080792, OLAX230V-1080793, OLAX230V-1080794, OLAX240, OLAX240E-1080795, OLAX240E-1080796, OLAX240V-1080797, OLAX240V-1080798, OLAX250, OLAX250E-1080760, OLAX250E-1080761, OLAX250V-1080765, OLAX250V-1080766, OLAX300, OLAX300E-1080770, OLAX300E-1080771, OLAX300E-1081033, OLAX300E-1081035, OLAX300E-1081036, OLAX300LC, OLAX300LCE-1081034, OLAX300V-1080775, OLAX300V-1080776, OLAX310, OLAX310E-1081110, OLAX310E-1081111, OLAX310LC, OLAX310LCE-1081114, OLAX310LCE-1081115...(Other models you can see in the webshop)		



knobs

producer-specific knobs

OLIS



1

GEV No.	111747	Ref. No.	3199020 BN3199020
description	knob switch zero mark ø 40mm shaft ø 6x4.6mm shaft flat upper black		
For models:	61FE-1826050, CV10E, CV10E-1320100, CV10E-2, CV10E2-1320140, CV10EB-1321100, CV10E-S, CV10ES-1320150, CV10E-S2, CV10ES2-1320190, CV10G, CV10G-1310100, CV10G-2, CV10G2-1310140, CV10GB-1311100, CV10G-S, CV10GS-1310150, CV10G-S2, CV10GS2-1310190, CV20E, CV20E-1320200, CV20E-2, CV20E2-1320240, CV20EB-1321200, CV20E-S, CV20ES-1320250, CV20E-S2, CV20ES2-1320290, CV20G, CV20G-1310200, CV20G-2, CV20G2-1310240, CV20GB-1311200, CV20G-S, CV20GS-1310250, CV20G-S2, CV20GS2-1310290, CV21E, CV21E-1322100, CV21E-2, CV21E2-1322140, CV21E-S, CV21ES-1322150, CV21E-S2, CV21ES2-1322190, CV21G, CV21G-1312100, CV21G-2, CV21G2-1312140, CV21G-S...(Other models you can see in the webshop)		

handles and hand wheels

cylindrical handles

fixed



1

GEV No.	110703	Ref. No.	1829200
description	cylindrical handle thread M10 ø 28mm L 87mm		
For models:	OPLG40, OPLG-40-12600850, OPLG80, OPLG-80-12600855, PLG40, PLG80		

locks

espagnolette locks

producer-specific

OLIS



1

GEV No.	514302	Ref. No.	6A011409 BN6A011409
description	ball ø 8mm		
For models:	CMV6ES2-1320392, CV10E, CV10E-1320100, CV10E-1320110, CV10E-2, CV10E2-1320140, CV10EB-1321100, CV10E-S, CV10ES-1320150, CV10E-S2, CV10ES2-1320190, CV10G, CV10G-1310100, CV10G-2, CV10G2-1310140, CV10GB-1311100, CV10G-S, CV10GS-1310150, CV10G-S2, CV10GS2-1310190, CV20E, CV20E-1320200, CV20E-2, CV20E2-1320240, CV20EB-1321200, CV20E-S, CV20ES-1320250, CV20E-S2, CV20ES2-1320290, CV20G, CV20G-1310200, CV20G-2, CV20G2-1310240, CV20GB-1311200, CV20G-S, CV20GS-1310250, CV20G-S2, CV20GS2-1310290, CV21E, CV21E-1322100, CV21E-2, CV21E2-1322140, CV21E-S, CV21ES-1322150, CV21E-S2, CV21ES2-1322190, CV21G, CV21G-1312100, CV21G-2, CV21G2-1312140...(Other models you can see in the webshop)		



1

GEV No.	514300	Ref. No.	3107935 BN3107935
description	bush		
For models:	CMV6ES2-1320392, CV10E, CV10E-1320100, CV10E-2, CV10E2-1320140, CV10EB-1321100, CV10E-S, CV10ES-1320150, CV10E-S2, CV10ES2-1320190, CV10G, CV10G-1310100, CV10G-2, CV10G2-1310140, CV10GB-1311100, CV10G-S, CV10GS-1310150, CV10G-S2, CV10GS2-1310190, CV20E, CV20E-1320200, CV20E-2, CV20E2-1320240, CV20EB-1321200, CV20E-S, CV20ES-1320250, CV20E-S2, CV20ES2-1320290, CV20G, CV20G-1310200, CV20G-2, CV20G2-1310240, CV20GB-1311200, CV20G-S, CV20GS-1310250, CV20G-S2, CV20GS2-1310290, CV21E, CV21E-1322100, CV21E-2, CV21E2-1322140, CV21E-S, CV21ES-1322150, CV21E-S2, CV21ES2-1322190, CV21G, CV21G-1312100, CV21G-2, CV21G2-1312140, CV21G-S...(Other models you can see in the webshop)		



1

GEV No.	514297	Ref. No.	3107915 BN3107915
description	catch hook L 78.6mm D1 ø 28mm D2 ø 32mm D3 ø 40mm		
For models:	CMV6ES2-1320392, CV10E, CV10E-1320100, CV10E-2, CV10E2-1320140, CV10EB-1321100, CV10E-S, CV10ES-1320150, CV10E-S2, CV10ES2-1320190, CV10G, CV10G-1310100, CV10G-2, CV10G2-1310140, CV10GB-1311100, CV10G-S, CV10GS-1310150, CV10G-S2, CV10GS2-1310190, CV20E, CV20E-1320200, CV20E-2, CV20E2-1320240, CV20EB-1321200, CV20E-S, CV20ES-1320250, CV20E-S2, CV20ES2-1320290, CV20G, CV20G-1310200, CV20G-2, CV20G2-1310240, CV20GB-1311200, CV20G-S, CV20GS-1310250, CV20G-S2, CV20GS2-1310290, CV6E, CV6E-1320000, CV6E-1320050, CV6E-2, CV6E2-1320040, CV6EB-1321000, CV6E-S, CV6E-S2, CV6ES2-1320090, CV6G, CV6G-1310000, CV6G-2, CV6G2-1310040...(Other models you can see in the webshop)		



GEV No.	514416	Ref. No.	3107991 BN3107991
description	catch hook L 92.5mm D1 ø 28mm D2 ø 32mm D3 ø 40mm		
For models:	CV10E, CV10E-2, CV10E-S, CV10E-S2, CV10G, CV10G-2, CV10G-S, CV10G-S2, CV20E, CV20E-2, CV20E-S, CV20E-S2, CV20G, CV20G-2, CV20G-S, CV20G-S2, CV21E, CV21E-1322100, CV21E-2, CV21E2-1322140, CV21E-S, CV21E-S-1322150, CV21E-S2, CV21ES2-1322190, CV21G, CV21G-1312100, CV21G-2, CV21G2-1312140, CV21G-S, CV21G-S-1312150, CV21G-S2, CV21GS2-1312190, CV6E, CV6E-2, CV6E-S, CV6E-S2, CV6G, CV6G-2, CV6G-S, CV6G-S2, CVM10E, CVM10E-2, CVM10E-S, CVM10E-S2, CVM20E, CVM20E-2, CVM20E-S, CVM20E-S2, CVM21E, CVM21E-1322400...(Other models you can see in the webshop)		











GEV No.	514301	Ref. No.	3107955 BN3107955
description	compression spring ø 6.5mm L 14mm wire gauge ø 1.2mm		
For models:	CMV6ES2-1320392, CV10E, CV10E-1320100, CV10E-1320110, CV10E-2, CV10E2-1320140, CV10EB-1321100, CV10E-S, CV10ES-1320150, CV10E-S2, CV10ES2-1320190, CV10G, CV10G-1310100, CV10G-2, CV10G2-1310140, CV10GB-1311100, CV10G-S, CV10GS-1310150, CV10G-S2, CV10GS2-1310190, CV20E, CV20E-1320200, CV20E-2, CV20E2-1320240, CV20EB-1321200, CV20E-S, CV20ES-1320250, CV20E-S2, CV20ES2-1320290, CV20G, CV20G-1310200, CV20G-2, CV20G2-1310240, CV20GB-1311200, CV20G-S, CV20GS-1310250, CV20G-S2, CV20GS2-1310290, CV21E, CV21E-1322100, CV21E-2, CV21E2-1322140, CV21E-S, CV21ES-1322150, CV21E-S2, CV21ES2-1322190, CV21G, CV21G-1312100, CV21G-2, CV21G2-1312140...(Other models you can see in the webshop)		



GEV No.	514296	Ref. No.	3107910 BN3107910
description	door catch H 28mm D1 ø 44mm D2 ø 35mm D3 ø 32mm mounting distance 10mm		
For models:	CMV6ES2-1320392, CV10E, CV10E-1320100, CV10E-1320110, CV10E-2, CV10E2-1320140, CV10EB-1321100, CV10E-S, CV10ES-1320150, CV10E-S2, CV10ES2-1320190, CV10G, CV10G-1310100, CV10G-2, CV10G2-1310140, CV10GB-1311100, CV10G-S, CV10GS-1310150, CV10G-S2, CV10GS2-1310190, CV20E, CV20E-1320200, CV20E-2, CV20E2-1320240, CV20EB-1321200, CV20E-S, CV20ES-1320250, CV20E-S2, CV20ES2-1320290, CV20G, CV20G-1310200, CV20G-2, CV20G2-1310240, CV20GB-1311200, CV20G-S, CV20GS-1310250, CV20G-S2, CV20GS2-1310290, CV21E, CV21E-1322100, CV21E-2, CV21E2-1322140, CV21E-S, CV21ES-1322150, CV21E-S2, CV21ES2-1322190, CV21G, CV21G-1312100, CV21G-2, CV21G2-1312140...(Other models you can see in the webshop)		





GEV No.	514295	Ref. No.	3107990 BN3107990	
description	door handle complete			
For models:	CV21E-1322100, CV21E2-1322140, CV21ES-1322150, CV21ES2-1322190, CV21G-1312100, CV21G2-1312140, CV21GS-1312150, CV21GS2-1312190, CVM21E-1322400, CVM21E2-1322440, CVM21ES-1322450, CVM21ES2-1322490, CVM21ES2-1322495, CVM21G-1312400, CVM21G2-1312440, CVM21GS-1312450, CVM21GS2-1312490, CVM21GS2-1312495, CVP21E-1322700, CVP21ES-1322750, CVP21ES2-1322790, CVP21G-1312700, CVP21G2-1312740, CVP21GS-1312750, CVP21GS2-1312790, ECVM21ES2-1324490, ECVM21ES2-1326160, ECVM21GS2-1314490, ECVM21GS2-1316160, ECVP21ES2-1324890, ECVP21ES2-1326240, ECVP21GS2-1314890, ECVP21GS2-1316240, NECVM21ES2-1327490, NECVM21ES2-1328160, NECVM21GS2-1317490, NECVM21GS2-1318160, NECVP21ES2-1327890, NECVP21ES2-1328240, NECVP21GS2-1317890, NECVP21GS2-1318240			
spare parts for	514295			
	GEV No.	514298	Ref. No.	3107945 BN3107945
	plate			
	GEV No.	514299	Ref. No.	3107941 BN3107941
	ring			
	GEV No.	514300	Ref. No.	3107935 BN3107935
	bush			
	GEV No.	514301	Ref. No.	3107955 BN3107955
	compression spring ø 6.5mm L 14mm wire gauge ø 1.2mm			
	GEV No.	514302	Ref. No.	6A011409 A011409 BN6A011409
	ball ø 8mm			
	GEV No.	514303	Ref. No.	3107930 BN3107930
	pin ø 8mm L 19.5mm			
	GEV No.	514416	Ref. No.	3107991 BN3107991
	catch hook L 92.5mm D1 ø 28mm D2 ø 32mm D3 ø 40mm			
accessories for	514295			
	GEV No.	514296	Ref. No.	3107910 BN3107910
	door catch H 28mm D1 ø 44mm D2 ø 35mm D3 ø 32mm mounting distance 10mm			



			
1			
GEV No.	514394	Ref. No.	3107900 BN3107900
description	door handle complete		
For models:	CMV6ES2-1320392, CV10E-1320100, CV10E2-1320140, CV10EB-1321100, CV10ES-1320150, CV10ES2-1320190, CV10G-1310100, CV10G2-1310140, CV10GB-1311100, CV10GS-1310150, CV10GS2-1310190, CV20E-1320200, CV20E2-1320240, CV20EB-1321200, CV20ES-1320250, CV20ES2-1320290, CV20G-1310200, CV20G2-1310240, CV20GB-1311200, CV20GS-1310250, CV20GS2-1310290, CV6E-1320000, CV6E-1320050, CV6E2-1320040, CV6EB-1321000, CV6ES2-1320090, CV6G-1310000, CV6G2-1310040, CV6GB-1311000, CV6GS-1310050, CV6GS2-1310090, CVM10E-1320400, CVM10E2-1320440, CVM10ES-1320450, CVM10ES2-1320490, CVM10ES2-1320495, CVM10G-1310400, CVM10G-1310410, CVM10G-1310430, CVM10G-1310450, CVM10G2-1310440, CVM10GP-1310400, CVM10GS2-1310490, CVM10GS2-1310495, CVM20E-1320500, CVM20E2-1320540, CVM20ES-1320550, CVM20ES2-1320590, CVM20G-1310500, CVM20G2-1310540...(Other models you can see in the webshop)		
spare parts for	514394		
	GEV No.	514297	Ref. No. 3107915 BN3107915
catch hook L 78.6mm D1 ø 28mm D2 ø 32mm D3 ø 40mm			
	GEV No.	514298	Ref. No. 3107945 BN3107945
plate			
	GEV No.	514299	Ref. No. 3107941 BN3107941
ring			
	GEV No.	514300	Ref. No. 3107935 BN3107935
bush			
	GEV No.	514301	Ref. No. 3107955 BN3107955
compression spring ø 6.5mm L 14mm wire gauge ø 1.2mm			
	GEV No.	514302	Ref. No. 6A011409 A011409 BN6A011409
ball ø 8mm			
	GEV No.	514303	Ref. No. 3107930 BN3107930
pin ø 8mm L 19.5mm			
accessories for	514394		
	GEV No.	514296	Ref. No. 3107910 BN3107910
door catch H 28mm D1 ø 44mm D2 ø 35mm D3 ø 32mm mounting distance 10mm			

			
1			
GEV No.	514303	Ref. No.	3107930 BN3107930
description	pin ø 8mm L 19.5mm		
For models:	CMV6ES2-1320392, CV10E, CV10E-1320100, CV10E-1320110, CV10E-2, CV10E2-1320140, CV10EB-1321100, CV10E-S, CV10ES-1320150, CV10E-S2, CV10ES2-1320190, CV10G, CV10G-1310100, CV10G-2, CV10G2-1310140, CV10GB-1311100, CV10G-S, CV10GS-1310150, CV10G-S2, CV10GS2-1310190, CV20E, CV20E-1320200, CV20E-2, CV20E2-1320240, CV20EB-1321200, CV20E-S, CV20ES-1320250, CV20E-S2, CV20ES2-1320290, CV20G, CV20G-1310200, CV20G-2, CV20G2-1310240, CV20GB-1311200, CV20G-S, CV20GS-1310250, CV20G-S2, CV20GS2-1310290, CV21E, CV21E-1322100, CV21E-2, CV21E2-1322140, CV21E-S, CV21ES-1322150, CV21E-S2, CV21ES2-1322190, CV21G, CV21G-1312100, CV21G-2, CV21G2-1312140...(Other models you can see in the webshop)		

			
1			
GEV No.	514298	Ref. No.	3107945 BN3107945
description	plate		
For models:	CMV6ES2-1320392, CV10E, CV10E-1320100, CV10E-2, CV10E2-1320140, CV10EB-1321100, CV10E-S, CV10ES-1320150, CV10E-S2, CV10ES2-1320190, CV10G, CV10G-1310100, CV10G-2, CV10G2-1310140, CV10GB-1311100, CV10G-S, CV10GS-1310150, CV10G-S2, CV10GS2-1310190, CV20E, CV20E-1320200, CV20E-2, CV20E2-1320240, CV20EB-1321200, CV20E-S, CV20ES-1320250, CV20E-S2, CV20ES2-1320290, CV20G, CV20G-1310200, CV20G-2, CV20G2-1310240, CV20GB-1311200, CV20G-S, CV20GS-1310250, CV20G-S2, CV20GS2-1310290, CV21E, CV21E-1322100, CV21E-2, CV21E2-1322140, CV21E-S, CV21ES-1322150, CV21E-S2, CV21ES2-1322190, CV21G, CV21G-1312100, CV21G-2, CV21G2-1312140, CV21G-S...(Other models you can see in the webshop)		

			
1			
GEV No.	514299	Ref. No.	3107941 BN3107941
description	ring		
For models:	CMV6ES2-1320392, CV10E, CV10E-1320100, CV10E-1320110, CV10E-2, CV10E2-1320140, CV10EB-1321100, CV10E-S, CV10ES-1320150, CV10E-S2, CV10ES2-1320190, CV10G, CV10G-1310100, CV10G-2, CV10G2-1310140, CV10GB-1311100, CV10G-S, CV10GS-1310150, CV10G-S2, CV10GS2-1310190, CV20E, CV20E-1320200, CV20E-2, CV20E2-1320240, CV20EB-1321200, CV20E-S, CV20ES-1320250, CV20E-S2, CV20ES2-1320290, CV20G, CV20G-1310200, CV20G-2, CV20G2-1310240, CV20GB-1311200, CV20G-S, CV20GS-1310250, CV20G-S2, CV20GS2-1310290, CV21E, CV21E-1322100, CV21E-2, CV21E2-1322140, CV21E-S, CV21ES-1322150, CV21E-S2, CV21ES2-1322190, CV21G, CV21G-1312100, CV21G-2, CV21G2-1312140...(Other models you can see in the webshop)		

miscellaneous



1			
GEV No.	691286	Ref. No.	LAR58001780
description	catch for glass plate		
For models:	CCE071M, CCE101M, CCE102M, CCG071M, CCG101M, CCG102M, CKEP06, CKEP06B, CKEP10, CKEP10B, CKEP20, CKEP20B, CKEP21, CKEP21B, CKEP40, CKEP40B, CKET06, CKET06B, CKET10, CKET10B, CKET20, CKET20B, CKET21, CKET21B, CKET40, CKET40B, CKGP06, CKGP06B, CKGP10, CKGP10B, CKGP20, CKGP20B, CKGP21, CKGP21B, CKGP40, CKGP40B, CKGT06, CKGT06B, CKGT10, CKGT10B, CKGT20B, CKGT21, CKGT21B, CKGT40, CKGT40B		

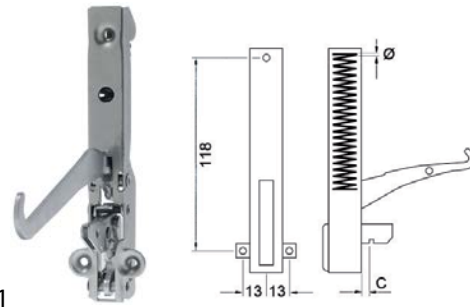

1			
GEV No.	690030	Ref. No.	1034400400
description	oven hinge mounting distance 118mm lug mounting 13mm lever length 117mm groove distance 10mm spring thickness 3.5mm mounting ear position left/right spring length 60mm L 155mm W 21mm		
For models:	CFE60, CFE60P, OCFE60, OCFE-60-12601005, OCFE-60-12601005MN, OCFGE61		
accessories for	690030		
	GEV No.	700003	Ref. No. 1031106000 1034400800
	opposite support L 110mm W 12mm mounting distance 94mm		

hinges

oven hinges

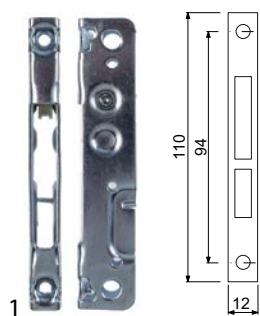

1			
GEV No.	693045	Ref. No.	6A035990 BN6A035990
description	opposite support L 110mm W 12mm mounting distance 94mm		
For models:	61FE-1826050, 61SCGFE3S-1826055, 61SCGFE4S-1827055, 61SECFE-1826075		

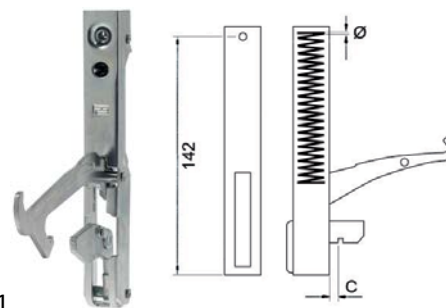

1			
GEV No.	700459	Ref. No.	6A035980 BN6A035980
description	oven hinge mounting distance 142mm mounting distance 2mm lug mountingmm lever length 117mm groove distance 7mm spring thickness 3.5mm mounting ear position spring length 58mm L 156mm W 22mm		
For models:	61FE-1826050, 61SCGFE3S-1826055, 61SCGFE4S-1827055, 61SECFE-1826075		
accessories for	700459		
	GEV No.	693045	Ref. No. 6A035990 A035990 BN6A035990
	opposite support L 110mm W 12mm mounting distance 94mm		

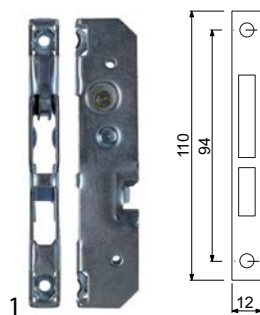

1			
GEV No.	700003	Ref. No.	1031106000 1034400800
description	opposite support L 110mm W 12mm mounting distance 94mm		
For models:	CFE60, CFE60P, FOE60M, OCFE60, OCFE-60-12601005, OCFE-60-12601005MN, OCFGE61, OFOE60M, OFOE-60M-12601001		

door bearing



1			
GEV No.	691288	Ref. No.	R58002520
description	door bolt		
For models:	CCE071M, CCE101M, CCE102M, CCG071M, CCG101M, CCG102M		





			
1			
GEV No.	692831	Ref. No.	LA58002670 LAR58002670
description	door bolt mounting pos. bottom left thread M12 bolt 15mm bolt ø 10mm		
For models:	CKEP06, CKEP06B, CKEP10, CKEP10B, CKEP20, CKEP20B, CKET06, CKET06B, CKET10, CKET10B, CKET20, CKET20B, CKGP06, CKGP06B, CKGP10, CKGP10B, CKGP20, CKGP20B, CKGT06, CKGT06B, CKGT10, CKGT10B, CKGT20B		

			
1			
GEV No.	691287	Ref. No.	R18404500
description	hinge		
For models:	CCE071M, CCE101M, CCE102M, CCG071M, CCG101M, CCG102M		

			
1			
GEV No.	691284	Ref. No.	LA58001760 LAR58001760
description	hinge for glass plate		
For models:	CCE071M, CCE101M, CCE102M, CCG071M, CCG101M, CCG102M, CKEP06, CKEP06B, CKEP10, CKEP10B, CKEP20, CKEP20B, CKEP21, CKEP21B, CKEP40, CKEP40B, CKET06, CKET06B, CKET10, CKET10B, CKET20, CKET20B, CKET21, CKET21B, CKET40, CKET40B, CKGP06, CKGP06B, CKGP10, CKGP10B, CKGP20, CKGP20B, CKGP21, CKGP21B, CKGP40, CKGP40B, CKGT06, CKGT06B, CKGT10, CKGT10B, CKGT20B, CKGT21, CKGT21B, CKGT40, CKGT40B		

			
1			
GEV No.	691277	Ref. No.	R18201270
description	hinge mounting pos. bottom left		
For models:	CCE042M, CCE051M, CCG051M		

			
1			
GEV No.	514292	Ref. No.	3106800 BN3106800
description	hinge bearing mounting pos. lower without bolt		
For models:	CMV6ES2-1320392, CV10E, CV10E-1320100, CV10E-2, CV10E2-1320140, CV10EB-1321100, CV10E-S, CV10ES-1320150, CV10E-S2, CV10ES2-1320190, CV10G, CV10G-1310100, CV10G-2, CV10G2-1310140, CV10GB-1311100, CV10G-S, CV10GS-1310150, CV10G-S2, CV10GS2-1310190, CV20E, CV20E-1320200, CV20E-2, CV20E2-1320240, CV20EB-1321200, CV20E-S, CV20ES-1320250, CV20E-S2, CV20ES2-1320290, CV20G, CV20G-1310200, CV20G-2, CV20G2-1310240, CV20GB-1311200, CV20G-S, CV20GS-1310250, CV20G-S2, CV20GS2-1310290, CV6E, CV6E-1320000, CV6E-1320050, CV6E-2, CV6E2-1320040, CV6EB-1321000, CV6E-S, CV6E-S2, CV6ES2-1320090, CV6G, CV6G-1310000, CV6G-2, CV6G2-1310040... (Other models you can see in the webshop)		

			
1			
GEV No.	514294	Ref. No.	3106850 BN3106850
description	hinge bearing mounting pos. lower without bolt		
For models:	CV21E, CV21E-1322100, CV21E-2, CV21E2-1322140, CV21E-S, CV21ES-1322150, CV21E-S2, CV21ES2-1322190, CV21G, CV21G-1312100, CV21G-2, CV21G2-1312140, CV21G-S, CV21GS-1312150, CV21G-S2, CV21GS2-1312190, CVM21E, CVM21E-1322400, CVM21E-2, CVM21E2-1322440, CVM21E-S, CVM21ES-1322450, CVM21E-S2, CVM21ES2-1322490, CVM21E-S2-1322495, CVM21G, CVM21G-1312400, CVM21G-2, CVM21G2-1312440, CVM21G-S, CVM21GS-1312450, CVM21G-S2, CVM21GS2-1312490, CVM21GS2-1312495, CVP21E, CVP21E-1322700, CVP21E-2, CVP21E-S, CVP21ES-1322750, CVP21E-S2, CVP21ES2-1322790, CVP21G, CVP21G-1312700, CVP21G-2, CVP21G2-1312740, CVP21G-S, CVP21GS-1312750, CVP21G-S2, CVP21GS2-1312790, ECVM21ES2-1324490... (Other models you can see in the webshop)		

			
1			
GEV No.	691276	Ref. No.	R18201260
description	hinge bearing mounting pos. upper left		
For models:	CCE042M, CCE051M, CCG051M		

mechanical components, equipment accessories

			
1			
GEV No.	514291	Ref. No.	3106700 BN3106700
description	hinge bearing mounting pos. upper left without bolt		
For models:	CMV6ES2-1320392, CV10E, CV10E-1320100, CV10E-1320110, CV10E-2, CV10E2-1320140, CV10EB-1321100, CV10E-S, CV10ES-1320150, CV10E-S2, CV10ES2-1320190, CV10G, CV10G-1310100, CV10G-2, CV10G2-1310140, CV10GB-1311100, CV10G-S, CV10GS-1310150, CV10G-S2, CV10GS2-1310190, CV20E, CV20E-1320200, CV20E-2, CV20E2-1320240, CV20EB-1321200, CV20E-S, CV20ES-1320250, CV20E-S2, CV20ES2-1320290, CV20G, CV20G-1310200, CV20G-2, CV20G2-1310240, CV20GB-1311200, CV20G-S, CV20GS-1310250, CV20G-S2, CV20GS2-1310290, CV6E, CV6E-1320000, CV6E-1320010, CV6E-1320050, CV6E-2, CV6E2-1320040, CV6EB-1321000, CV6E-S, CV6E-S2, CV6ES2-1320090, CV6G, CV6G-1310000...(Other models you can see in the webshop)		

			
2			
GEV No.	690586	Ref. No.	LA11426830 R11200560
description	hinge bearing mounting pos. upper left without bolt		
For models:	CCE071M, CCE101M, CCE102M, CCG071M, CCG101M, CCG102M, CKEP06, CKEP06B, CKEP10, CKEP10B, CKEP20, CKEP20B, CKEP21, CKEP21B, CKEP40, CKEP40B, CKET06, CKET06B, CKET10, CKET10B, CKET20, CKET20B, CKET21, CKET21B, CKET40, CKET40B, CKGP06, CKGP06B, CKGP10, CKGP10B, CKGP20, CKGP20B, CKGP21, CKGP21B, CKGP40, CKGP40B, CKGT06, CKGT06B, CKGT10, CKGT10B, CKGT20B, CKGT21, CKGT21B, CKGT40, CKGT40B		

			
1			
GEV No.	514293	Ref. No.	3106750 BN3106750
description	hinge bearing mounting pos. upper right without bolt		
For models:	CV21E, CV21E-1322100, CV21E-2, CV21E2-1322140, CV21E-S, CV21ES-1322150, CV21E-S2, CV21ES2-1322190, CV21G, CV21G-1312100, CV21G-2, CV21G2-1312140, CV21G-S, CV21GS-1312150, CV21G-S2, CV21GS2-1312190, CVM21E, CVM21E-1322400, CVM21E-2, CVM21E2-1322440, CVM21E-S, CVM21ES-1322450, CVM21E-S2, CVM21ES2-1322490, CVM21ES2-1322495, CVM21G, CVM21G-1312400, CVM21G-2, CVM21G2-1312440, CVM21G-S, CVM21GS-1312450, CVM21G-S2, CVM21GS2-1312490, CVM21GS2-1312495, CVP21E, CVP21E-1322700, CVP21E-2, CVP21E-S, CVP21ES-1322750, CVP21E-S2, CVP21ES2-1322790, CVP21G, CVP21G-1312700, CVP21G-2, CVP21G2-1312740, CVP21G-S, CVP21GS-1312750, CVP21G-S2, CVP21GS2-1312790, ECVM21ES2-1324490...(Other models you can see in the webshop)		

			
1			
GEV No.	514524	Ref. No.	LA11207240 LAR11207240
description	hinge bearing without bolt for combi-steamer mounting pos. bottom left		
For models:	CKEP06, CKEP06B, CKEP10, CKEP10B, CKEP20, CKEP20B, CKET06, CKET06B, CKET10, CKET10B, CKET20, CKET20B, CKGP06, CKGP06B, CKGP10, CKGP10B, CKGP20, CKGP20B, CKGT06, CKGT06B, CKGT10, CKGT10B, CKGT20B		

			
1			
GEV No.	691285	Ref. No.	LA58001770 LAR58001770
description	hinge bolt		
For models:	CCE071M, CCE101M, CCE102M, CCG071M, CCG101M, CCG102M, CKEP06, CKEP06B, CKEP10, CKEP10B, CKEP20, CKEP20B, CKEP21, CKEP21B, CKEP40, CKEP40B, CKET06, CKET06B, CKET10, CKET10B, CKET20, CKET20B, CKET21, CKET21B, CKET40, CKET40B, CKGP06, CKGP06B, CKGP10, CKGP10B, CKGP20, CKGP20B, CKGP21, CKGP21B, CKGP40, CKGP40B, CKGT06, CKGT06B, CKGT10, CKGT10B, CKGT20B, CKGT21, CKGT21B, CKGT40, CKGT40B		

			
1			
GEV No.	690099	Ref. No.	LA58002150 LAR58002150
description	hinge pin mounting pos. upper for door		
For models:	CCE071M, CCE101M, CCE102M, CCG071M, CCG101M, CCG102M, CKEP06, CKEP06B, CKEP10, CKEP10B, CKEP20, CKEP20B, CKEP21, CKEP21B, CKEP40, CKEP40B, CKET06, CKET06B, CKET10, CKET10B, CKET20, CKET20B, CKET21, CKET21B, CKET40, CKET40B, CKGP06, CKGP06B, CKGP10, CKGP10B, CKGP20, CKGP20B, CKGP21, CKGP21B, CKGP40, CKGP40B, CKGT06, CKGT06B, CKGT10, CKGT10B, CKGT20B, CKGT21, CKGT21B, CKGT40, CKGT40B		

accessories

miscellaneous

			
1			
GEV No.	690595	Ref. No.	LA58002550 LAR58002550
description	bush for door hinge		
For models:	CKEP21, CKEP21B, CKEP40, CKEP40B, CKET21, CKET21B, CKET40, CKET40B, CKGP21, CKGP21B, CKGP40, CKGP40B, CKGT21, CKGT21B, CKGT40, CKGT40B		



			
1			
GEV No.	690592	Ref. No.	LAR58002540
description	pin for hinge		
For models:	CKEP21, CKEP21B, CKEP40, CKEP40B, CKET21, CKET21B, CKET40, CKET40B, CKGP21, CKGP21B, CKGP40, CKGP40B, CKGT21, CKGT21B, CKGT40, CKGT40B		

			
1			
GEV No.	690593	Ref. No.	LA58002570 LAR58002570
description	plain washer ID ø 15mm ED ø 30mm thickness 3mm Qty 1 pcs for door hinge		
For models:	CKEP21, CKEP21B, CKEP40, CKEP40B, CKET21, CKET21B, CKET40, CKET40B, CKGP21, CKGP21B, CKGP40, CKGP40B, CKGT21, CKGT21B, CKGT40, CKGT40B		

			
1			
GEV No.	690594	Ref. No.	LA58002560 LAR58002560
description	pressure screw for door hinge		
For models:	CKEP21, CKEP21B, CKEP40, CKEP40B, CKET21, CKET21B, CKET40, CKET40B, CKGP21, CKGP21B, CKGP40, CKGP40B, CKGT21, CKGT21B, CKGT40, CKGT40B		

DERBY RUOTE

spare parts and accessories

miscellaneous

			
1			
GEV No.	560193	Ref. No.	15812699 MA15812699
description	tooth lock washer ID ø 10.4mm ED ø 18mm zinc-coated steel DIN/ISO DIN 6798A Qty 1 pcs for thread M10		
For models:	CPE60, CPE60DB, OCPE60, OCPE-60-12601900, OCPE-60-12601900MN		

TENTE

with fixing plate

stainless steel

			
1			
GEV No.	701624	Ref. No.	R69090100
description	swivel castor with swivel brake ø 125mm plate fixing housing stainless steel plate size 105x85mm hole distance 78x60mm capacity 200kg bearing slide bearing wheel body polyamide tread polyurethane H 155mm wheel width 32mm		
For models:	CKEP21, CKEP21B, CKEP40, CKEP40B, CKET21, CKET21B, CKET40, CKET40B, CKGP21, CKGP21B, CKGP40, CKGP40B, CKGT21, CKGT21B, CKGT40, CKGT40B		

			
1			
GEV No.	701622	Ref. No.	R69090090
description	swivel castor without brake ø 125mm plate fixing housing stainless steel plate size 105x85mm hole distance 78x60mm capacity 200kg bearing slide bearing wheel body polyamide tread polyurethane H 155mm wheel width 32mm		
For models:	CKEP21, CKEP21B, CKEP40, CKEP40B, CKET21, CKET21B, CKET40, CKET40B, CKGP21, CKGP21B, CKGP40, CKGP40B, CKGT21, CKGT21B, CKGT40, CKGT40B		

gaskets

gaskets for heated units

window seals

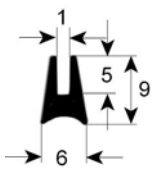
			
1			
GEV No.	900787	Ref. No.	R70044650
description	window gasket profile 1515 L 2200mm suitable for LAINOX		
For models:	CCE071M, CCG071M		

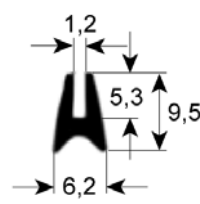
			
1			
GEV No.	900501	Ref. No.	R70044260
description	window gasket profile 1530 L 1200mm Qty 1		
For models:	CCE101M, CCE102M, CCG101M, CCG102M		

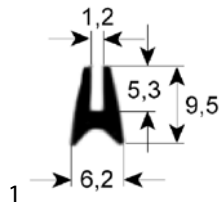

GEV No.	900504	Ref. No.	R70044290
description	window gasket profile 1530 L 1950mm Qty 1		
For models:	CKEP40, CKEP40B, CKET40, CKET40B, CKGP40, CKGP40B, CKGT40, CKGT40B		

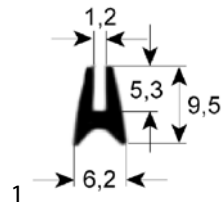

GEV No.	900637	Ref. No.	R70040640
description	window gasket profile 1530 Qty supplied by meter		
For models:	CKEP10, CKEP10B, CKET10, CKET10B, CKGP10, CKGP10B, CKGT10, CKGT10B		

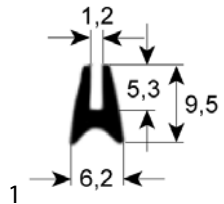

GEV No.	900483	Ref. No.	R70044150
description	window gasket profile 1530 L 2400mm Qty 1		
For models:	CCE101M, CCE102M, CCG101M, CCG102M, CKEP20, CKEP20B, CKET20, CKET20B, CKGP20, CKGP20B, CKGT20B		

door seals

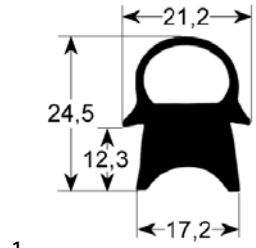

GEV No.	900107	Ref. No.	2891900 MA2891900
description	door seal profile 2440 W 645mm L 740mm external size Qty 1		

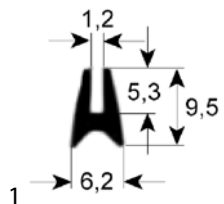

GEV No.	900484	Ref. No.	R70044160
description	window gasket profile 1530 L 3720mm Qty 1		
For models:	CKEP40, CKEP40B, CKET40, CKET40B, CKGP40, CKGP40B, CKGT40, CKGT40B		



GEV No.	900454	Ref. No.	3108820 BN3108820
description	door seal profile 2510 W 447mm L 1448mm external size		
For models:	CV21E, CV21E-1322100, CV21E-2, CV21E2-1322140, CV21E-S, CV21ES-1322150, CV21E-S2, CV21ES2-1322190, CV21G, CV21G-1312100, CV21G-2, CV21G2-1312140, CV21G-S, CV21GS-1312150, CV21G-S2, CV21GS2-1312190, CVM21E, CVM21E-1322400, CVM21E-2, CVM21E2-1322440, CVM21E-S, CVM21ES-1322450, CVM21E-S2, CVM21ES2-1322490, CVM21ES2-1322495, CVM21G, CVM21G-1312400, CVM21G-2, CVM21G2-1312440, CVM21G-S, CVM21GS-1312450, CVM21G-S2, CVM21GS2-1312490, CVM21GS2-1312495, CVP21E, CVP21E-1322700, CVP21E-2, CVP21E-S, CVP21ES-1322750, CVP21E-S2, CVP21ES2-1322790, CVP21G, CVP21G-1312700, CVP21G-2, CVP21G2-1312740, CVP21G-S, CVP21GS-1312750, CVP21G-S2, CVP21GS2-1312790, ECVM21ES2...(Other models you can see in the webshop)		

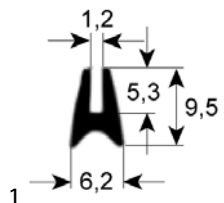

GEV No.	900500	Ref. No.	R70044250
description	window gasket profile 1530 L 900mm Qty 1		
For models:	CCE051M, CCE071M, CCG051M, CCG071M, CKEP06, CKEP06B, CKET06, CKET06B, CKGP06, CKGP06B, CKGT06, CKGT06B		

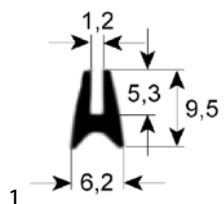

GEV No.	900143	Ref. No.	LAR80100100
description	window gasket profile 1530 Qty supplied by meter		



GEV No.	900451	Ref. No.	3108600 BN3108600
description	door seal profile 2510 W 450mm L 540mm external size Qty 1		
For models:	CMV6ES2-1320392, CV6E, CV6E-1320000, CV6E-1320010, CV6E-1320050, CV6E-2, CV6E2-1320040, CV6EB-1321000, CV6E-S, CV6E-S2, CV6ES2-1320090, CV6G, CV6G-1310000, CV6G-1310010, CV6G-2, CV6G2-1310040, CV6GB-1311000, CV6G-S, CV6GS-1310050, CV6G-S2, CV6GS2-1310090, CVM6E, CVM6E-1320300, CVM6E-1320340, CVM6E-1320390, CVM6E-2, CVM6E-S, CVM6ES-1320350, CVM6ES-1320350MN, CVM6ES-1320360, CVM6E-S2, CVM6ES2-1320395, CVM6G, CVM6G-1310300, CVM6G-1310310, CVM6G-2, CVM6G2-1310340, CVM6G-S, CVM6GS-1310350, CVM6GS-1310360, CVM6G-S2, CVM6GS2-1310390, CVM6GS2-1310395, CVP6E, CVP6E-1320600, CVP6E-2, CVP6E2-1320640, CVP6E-S, CVP6ES-1320650, CVP6E-S2...(Other models you can see in the webshop)		

GEV No.	900452	Ref. No.	3108700 BN3108700
description	door seal profile 2510 W 450mm L 780mm external size Qty 1		
For models:	CV10E, CV10E-1320100, CV10E-1320110, CV10E-2, CV10E2-1320140, CV10EB-1321100, CV10E-S, CV10ES-1320150, CV10E-S2, CV10ES2-1320190, CV10G, CV10G-1310100, CV10G-2, CV10G2-1310140, CV10GB-1311100, CV10G-S, CV10GS-1310150, CV10G-S2, CV10GS2-1310190, CVM10E, CVM10E-1320400, CVM10E-1320410, CVM10E-2, CVM10E2-1320440, CVM10E-S, CVM10ES-1320450, CVM10E-S2, CVM10ES2-1320490, CVM10ES2-1320495, CVM10G, CVM10G-1310400, CVM10G-1310410, CVM10G-1310430, CVM10G-1310450, CVM10G-2, CVM10G2-1310440, CVM10GP-1310400, CVM10G-S, CVM10GS-1310460, CVM10G-S2, CVM10GS2-1310490, CVM10GS2-1310495, CVP10E, CVP10E-1320700, CVP10E-1320710, CVP10E-2, CVP10E2-1320740, CVP10E2S-1320790, CVP10E-S, CVP10ES-1320750...(Other models you can see in the webshop)		

GEV No.	900453	Ref. No.	3108800 BN3108800
description	door seal profile 2510 W 640mm L 770mm external size Qty 1		
For models:	CV20E, CV20E-1320200, CV20E-2, CV20E2-1320240, CV20EB-1321200, CV20E-S, CV20ES-1320250, CV20E-S2, CV20ES2-1320290, CV20G, CV20G-1310200, CV20G-2, CV20G2-1310240, CV20GB-1311200, CV20G-S, CV20GS-1310250, CV20G-S2, CV20GS2-1310290, CVM20E, CVM20E-1320500, CVM20E-2, CVM20E2-1320540, CVM20E-S, CVM20ES-1320550, CVM20E-S2, CVM20ES2-1320590, CVM20G, CVM20G-1310500, CVM20G-2, CVM20G2-1310540, CVM20G-S, CVM20GS-1310550, CVM20G-S2, CVM20GS2-1310590, CVP20E, CVP20E-1320800, CVP20E-2, CVP20E2-1320840, CVP20EB-1321200, CVP20E-S, CVP20ES-1320850, CVP20E-S2, CVP20ES2-1320890, CVP20G, CVP20G-1310800, CVP20G-1310850, CVP20G-2, CVP20G-S, CVP20GS-1310840, CVP20G-S2...(Other models you can see in the webshop)		

GEV No.	902458	Ref. No.	LAR70044930 LAR70044932
description	door seal profile 2761 W 405mm L 685mm outer plug size Qty 1		

GEV No.	902023	Ref. No.	LA70048012 LAR70048010
description	door seal profile 2761 W 46mm L 775mm external size Qty 1 suitable for LAINOX		

GEV No.	902024	Ref. No.	LA70048002 LAR70048000
description	door seal profile 2761 W 470mm L 560mm external size Qty 1		

GEV No.	902153	Ref. No.	LA70044812 LAR70044810
description	door seal profile 2761 W 550mm L 700mm external size Qty 1 suitable for LAINOX		



GEV No.	902454	Ref. No.	LA70044882 LAR70044880
description	door seal profile 2761 W 690mm L 775mm outer plug size Qty 1 suitable for LAINOX		

GEV No.	902154	Ref. No.	LA70044922 LAR70044920
description	door seal profile 2761 W 700mm L 1510mm external size Qty 1 suitable for LAINOX		

GEV No.	901573	Ref. No.	R70044270
description	door seal profile 2770/2771 H 1550mm W 470mm outer plug size Qty 1		
For models:	CKEP10, CKEP10B, CKEP20, CKEP20B, CKEP21, CKEP21B, CKET10, CKET10B, CKET20, CKET20B, CKET21, CKET21B, CKGP10, CKGP10B, CKGP20, CKGP20B, CKGP21, CKGP21B, CKGT10, CKGT10B, CKGT20, CKGT20B, CKGT21, CKGT21B		

GEV No.	900494	Ref. No.	R70044140
description	door seal profile 2770/2771 H 1550mm W 700mm outer plug size Qty 1		
For models:	CKEP40, CKEP40B, CKET40, CKET40B, CKGP40, CKGP40B, CKGT40, CKGT40B		

GEV No.	900488	Ref. No.	R70044330
description	door seal profile 2770/2771 H 380mm W 420mm outer plug size Qty 1		
For models:	CCE042M		

GEV No.	900489	Ref. No.	R70044340
description	door seal profile 2770/2771 H 440mm W 600mm outer plug size Qty 1		
For models:	CCE051M, CCG051M		



1

GEV No.	901679	Ref. No.	R70044210
description	door seal profile 2770/2771 H 520mm W 470mm outer plug size suitable for LAINOX		
For models:	CKEP06, CKEP06B, CKET06, CKET06B, CKGP06, CKGP06B, CKGT06, CKGT06B		

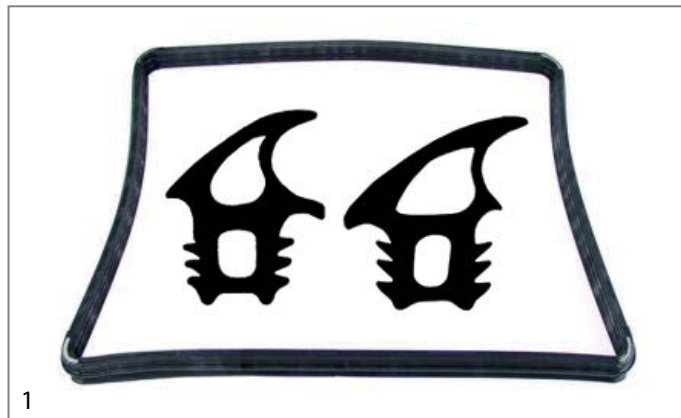

1

GEV No.	900491	Ref. No.	R70044110
description	door seal profile 2770/2771 H 800mm W 680mm outer plug size Qty 1		
For models:	CCE101M, CCG101M		



1

GEV No.	900788	Ref. No.	R70044230
description	door seal profile 2770/2771 H 580mm W 680mm outer plug size Qty 1		
For models:	CCE071M, CCG071M		



1

GEV No.	900492	Ref. No.	R70044120
description	door seal profile 2770/2771 H 800mm W 700mm outer plug size Qty 1		
For models:	CKEP20, CKEP20B, CKET20, CKET20B, CKGP20, CKGP20B, CKGT20, CKGT20B		



1

GEV No.	901276	Ref. No.	R70044220
description	door seal profile 2770/2771 H 800mm W 470mm outer plug size Qty 1 suitable for LAINOX		
For models:	CKEP10, CKEP10B, CKET10, CKET10B, CKGP10, CKGP10B, CKGT10, CKGT10B		

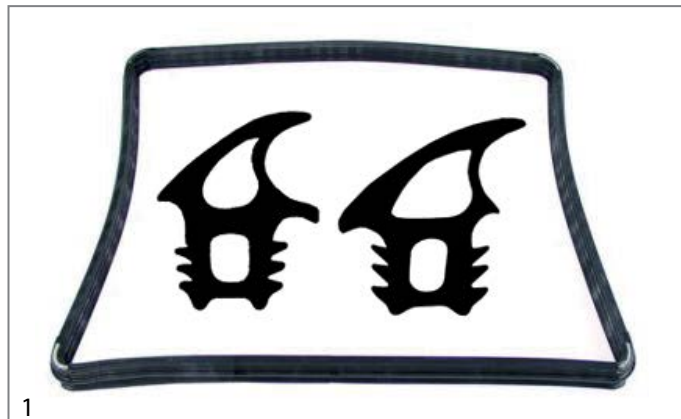

1

GEV No.	901603	Ref. No.	R70044240
description	door seal profile 2770/2771 H 800mm W 760mm outer plug size Qty 1		
For models:	CCE102M, CCG102M		

door seals with fixing hook



1

GEV No.	900405	Ref. No.	1036101400 MA1036101400
description	door seal L 430mm W 260mm external size		

gaskets for tray rack trolleys

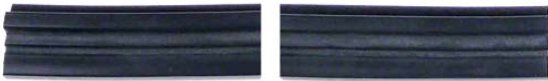

1

GEV No.	901160	Ref. No.	LAR70044360 LAR70044362
description	tray rack trolley gasket L <700mm 3-piece		
For models:	CKEP40, CKEP40B, CKET40, CKET40B, CKGP40, CKGP40B, CKGT40, CKGT40B		



1

GEV No.	901161	Ref. No.	LA80100910 LAR80100910
description	tray rack trolley gasket L 1000mm		
For models:	CKEP21, CKEP21B, CKEP40, CKEP40B, CKET21, CKET21B, CKET40, CKET40B, CKGP21, CKGP21B, CKGP40, CKGP40B, CKGT21, CKGT21B, CKGT40, CKGT40B		



1

GEV No.	901711	Ref. No.	R70044370
description	tray rack trolley gasket L 510mm 3-piece		
For models:	CKEP21, CKEP21B, CKET21, CKET21B, CKGP21, CKGP21B, CKGT21, CKGT21B		

O-rings

EPDM

ø1.78mm



1

GEV No.	510824	Ref. No.	13025
description	O-ring EPDM thickness 1.78mm ID ø 20.35mm Qty 1 pcs		
For models:	OLAX151, OLAX151EDX-1080725, OLAX151LEFT-1080727, OLAX151-highspeed, OLAX160, OLAX160E-1080750, OLAX160E-1080751, OLAX160V-1080755, OLAX160V-1080756, OLAX160V-1081031, OLAX160V-1081032, OLAX210, OLAX210E-1081029, OLAX210E-1081030, OLAX220, OLAX220E-1080787, OLAX220E-1080788, OLAX220V-1080789, OLAX220V-1080790, OLAX230, OLAX230E-1080791, OLAX230E-1080792, OLAX230V-1080793, OLAX230V-1080794, OLAX240, OLAX240E-1080795, OLAX240E-1080796, OLAX240V-1080797, OLAX240V-1080798, OLAX250, OLAX250E-1080760, OLAX250E-1080761, OLAX250V-1080765, OLAX250V-1080766, OLAX300, OLAX300E-1080770, OLAX300E-1080771, OLAX300E-1081033, OLAX300E-1081035, OLAX300E-1081036, OLAX300LC, OLAX300LCE-1081034, OLAX300V-1080775, OLAX300V-1080776, OLAX310, OLAX310E-1081110, OLAX310E-1081111, OLAX310LC, OLAX310LCE-1081114, OLAX310LCE-1081115...(Other models you can see in the webshop)		

ø2.62mm



1

GEV No.	528223	Ref. No.	15285
description	O-ring EPDM thickness 2.62mm ID ø 11.91mm Qty 1 pcs		



ø5.34mm

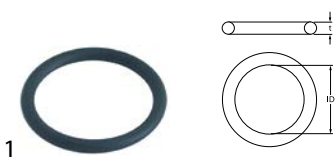

1

GEV No.	505092	Ref. No.	BN0119472130
description	O-ring EPDM thickness 5.34mm ID ø 43.82mm Qty 1 pcs		



1

GEV No.	510408	Ref. No.	13005
description	O-ring EPDM thickness 5.34mm ID ø 47mm Qty 1 pcs		
For models:	OLDS40-1081010, OLDS40D-1081011, OLDS40LS-1081012, OLDS40LSD-1081013, OLDS45, OLDS50, OLDS50-1081088, OLDS50D-1081089, OLDS50E-1081090, OLDS50ED-1081091, OLDS50-Neutra, OLDS50P-1081018, OLDS50PD-1081019, OLElectron500, OLG600, OLGastro450, OLGastro500Plus, OLGastro500S, OLGastro750Plus, OLGastro750S, OLG545, OLG550, OLG550-1080705, OLG550D-1080706, OLG550E-1080730, OLG550ECO-1081014, OLG550ECOD-1081015, OLG550ED-1080731, OLG550-Neutra, OLG585, OLG585-1081016, OLG585D-1081017, OLG585-Neutra, OLLinear, OLLP-ZERO, OLLPZERO-1081057		

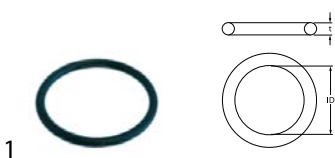

1

GEV No.	510409	Ref. No.	13015 LA70045010 LAR70045010
description	O-ring EPDM thickness 5.34mm ID ø 56.52mm Qty 1 pcs		
For models:	CKEP06B, CKEP10B, CKEP20B, CKEP21, CKEP21B, CKET06B, CKET10B, CKET20B, CKET21, CKET21B, CKGP21, CKGP21B, CKGT21, CKGT21B, G125, OLAX151, OLAX151EDX-1080725, OLAX151ELEFT-1080727, OLAX151-highspeed, OLAX160, OLAX160E-1080750, OLAX160E-1080751, OLAX160V-1080755, OLAX160V-1080756, OLAX160V-1081031, OLAX160V-1081032, OLAX210, OLAX210E-1081029, OLAX210E-1081030, OLAX220, OLAX220E-1080787, OLAX220E-1080788, OLAX220V-1080789, OLAX220V-1080790, OLAX230, OLAX230E-1080791, OLAX230E-1080792, OLAX230V-1080793, OLAX230V-1080794, OLAX240, OLAX240E-1080795, OLAX240E-1080796, OLAX240V-1080797, OLAX240V-1080798, OLAX250, OLAX250E-1080760, OLAX250E-1080761, OLAX250V-1080765, OLAX250V-1080766, OLAX300...(Other models you can see in the webshop)		

miscellaneous

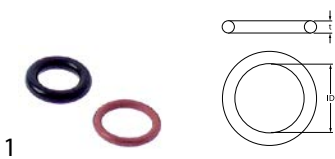

1

GEV No.	532492	Ref. No.	LAR70010050
description	O-ring set EPDM thickness 1.78/2.62mm ID ø 9.25/7.59mm Qty 2 pcs		
For models:	CKEP06, CKEP06B, CKEP10, CKEP10B, CKEP20, CKEP20B, CKEP21, CKEP21B, CKEP40, CKEP40B, CKET06, CKET06B, CKET10, CKET10B, CKET20, CKET20B, CKET21, CKET21B, CKET40, CKET40B, CKGP06, CKGP06B, CKGP10, CKGP10B, CKGP20, CKGP20B, CKGP21, CKGP21B, CKGP40, CKGP40B, CKGT06, CKGT06B, CKGT10, CKGT10B, CKGT20, CKGT20B, CKGT21, CKGT21B, CKGT40, CKGT40B		

Viton

ø2.00mm

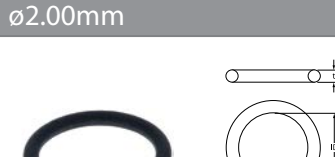

1

GEV No.	512506	Ref. No.	LA70010080 LAR70010080
description	O-ring Viton thickness 2mm ID ø 14mm Qty 1 pcs		

sealing washers

fibre gaskets



1

GEV No.	510404	Ref. No.	6A022280 BN6A022280
description	flat gasket fibre ED ø 44mm ID ø 34mm thickness 2mm Qty 1 pcs		
For models:	74-02NPEI, 74-02NPEI-12701755, 74-02NPGD, 74-02NPGD-12700750, 74-02NPGI, 74-02NPGI-12700755, 7NP-G50, 7NP-GI50, 7PN-EI50		

graphite gaskets



1

GEV No.	696702	Ref. No.	LA63140070 LAR63140070
description	gasket graphite ED ø 84mm ID ø 61mm thickness 3mm Qty 1 pcs		
For models:	CCG051M, CCG071M, CKGP06, CKGP06B, CKGT06, CKGT06B		

shaft gaskets

shaft gaskets



1

GEV No.	511171	Ref. No.	LA70020040 LAR70020040
description	shaft seal ID ø 14.5mm ED ø 20mm thickness 3mm		
For models:	CCE071M, CCG071M, CKEP06, CKEP06B, CKEP10, CKEP10B, CKEP21, CKEP21B, CKET06, CKET06B, CKET10, CKET10B, CKET21, CKET21B, CKGP06, CKGP06B, CKGT06, CKGT06B		

3 mechanical components, equipment accessories



1

GEV No.	511172	Ref. No.	LA70020050 LAR70020050
description	shaft sealing ID ø 24mm ED ø 29mm thickness 3mm		
For models:	CCE101M, CCE102M, CCG101M, CCG102M, CKEP20, CKEP20B, CKEP40, CKEP40B, CKET20, CKET20B, CKET40, CKET40B, CKGP10, CKGP10B, CKGP20, CKGP20B, CKGP21, CKGP21B, CKGP40, CKGP40B, CKGT10B, CKGT20, CKGT20B, CKGT21, CKGT21B, CKGT40, CKGT40B		

special gaskets

for combi-steamers



1

GEV No.	512507	Ref. No.	LA70050090 LAR70050090
description	gasket suitable for LAINOX ED ø 23mm ID ø 15.5mm rubber thickness 3.2mm 21 Qty 1 pcs		



1

GEV No.	699384	Ref. No.	LA63140050 LAR63140050
description	gasket suitable for LAINOX ED ø 84mm ID ø 50mm fibre thickness 2mm hole distance 50mm hole ø 6mm		
For models:	CCG051M, CCG071M, CCG101M, CCG102M, CKGP06, CKGP06B, CKGP10, CKGP10B, CKGP20, CKGP20B, CKGP21, CKGP21B, CKGP40, CKGP40B, CKGT06, CKGT06B, CKGT10, CKGT10B, CKGT20, CKGT20B, CKGT21, CKGT21B, CKGT40, CKGT40B		



1

GEV No.	694955	Ref. No.	LA63140010 LAR63140010
description	gasket suitable for LAINOX L 80mm W 65mm combi-steamer ID ø 51mm graphite thickness 3mm hole distance 45x60mm		
For models:	CCG051M, CCG071M, CCG101M, CCG102M, CKGP06, CKGP06B, CKGP10, CKGP10B, CKGP20, CKGP20B, CKGP21, CKGP21B, CKGP40, CKGP40B, CKGT06, CKGT06B, CKGT10, CKGT10B, CKGT20, CKGT20B, CKGT21, CKGT21B, CKGT40, CKGT40B		



1

GEV No.	699383	Ref. No.	LA63140080 LAR63140080
description	gasket suitable for LAINOX Qty 1m ED ø 126mm ID ø 90mm graphite thickness 3mm hole distance 42mm hole ø 7mm		
For models:	CCG101M, CCG102M, CKGP10, CKGP10B, CKGP20, CKGP20B, CKGP21, CKGP21B, CKGP40, CKGP40B, CKGT10, CKGT10B, CKGT20, CKGT20B, CKGT21, CKGT21B, CKGT40, CKGT40B		



1

GEV No.	699247	Ref. No.	LAR70045120
description	gasket set for combi-steamer		



1

GEV No.	699385	Ref. No.	R70045100
description	gasket set suitable for LAINOX for cleaning system		
For models:	CKEP06, CKEP06B, CKEP10, CKEP10B, CKEP20, CKEP20B, CKEP21, CKEP21B, CKEP40, CKEP40B, CKET06, CKET06B, CKET10, CKET10B, CKET20, CKET20B, CKET21, CKET21B, CKET40, CKET40B, CKGP06, CKGP06B, CKGP10, CKGP10B, CKGP20, CKGP20B, CKGP21, CKGP21B, CKGP40, CKGP40B, CKGT06, CKGT06B, CKGT10, CKGT10B, CKGT20, CKGT20B, CKGT21, CKGT21B, CKGT40, CKGT40B		

springs

torsion springs





1

GEV No.	690095	Ref. No.	R61620012
description	torsion spring ø 6mm L2 15mm wire gauge ø 0.9mm L1 2x6mm L3 15mm Qty 1 pcs for closing hub		
For models:	CCE042M, CCE051M, CCE071M, CCE101M, CCE102M, CCG051M, CCG071M, CCG101M, CCG102M		





compression springs

			
GEV No.	690091	Ref. No.	R61620041
description	compression spring ø 12mm L 49mm wire gauge ø 1mm		
For models:	CCE042M, CCE051M, CCE071M, CCE101M, CCE102M, CCG051M, CCG071M, CCG101M, CCG102M		

			
GEV No.	514301	Ref. No.	3107955 BN3107955
description	compression spring ø 6.5mm L 14mm wire gauge ø 1.2mm		
For models:	CMV6ES2-1320392, CV10E, CV10E-1320100, CV10E-1320110, CV10E-2, CV10E2-1320140, CV10EB-1321100, CV10E-S, CV10ES-1320150, CV10E-S2, CV10ES2-1320190, CV10G, CV10G-1310100, CV10G-2, CV10G2-1310140, CV10GB-1311100, CV10G-S, CV10GS-1310150, CV10G-S2, CV10GS2-1310190, CV20E, CV20E-1320200, CV20E-2, CV20E2-1320240, CV20EB-1321200, CV20E-S, CV20ES-1320250, CV20E-S2, CV20ES2-1320290, CV20G, CV20G-1310200, CV20G-2, CV20G2-1310240, CV20GB-1311200, CV20G-S, CV20GS-1310250, CV20G-S2, CV20GS2-1310290, CV21E, CV21E-1322100, CV21E-2, CV21E2-1322140, CV21E-S, CV21ES-1322150, CV21E-S2, CV21ES2-1322190, CV21G, CV21G-1312100, CV21G-2, CV21G2-1312140...(Other models you can see in the webshop)		

manometers

			
GEV No.	541876	Ref. No.	2000244
description	manometer ø 49mm pressure range 0-4bar connection lower marking adjustable thread 1/4"		
For models:	OLAX151, OLAX151EDX-1080725, OLAX151LEFT-1080727, OLAX151-highspeed, OLAX160, OLAX160E-1080750, OLAX160E-1080751, OLAX160V-1080755, OLAX160V-1080756, OLAX160V-1081031, OLAX160V-1081032, OLAX210, OLAX210E-1081029, OLAX210E-1081030, OLAX220, OLAX220E-1080787, OLAX220E-1080788, OLAX220V-1080789, OLAX220V-1080790, OLAX230, OLAX230E-1080791, OLAX230E-1080792, OLAX230V-1080793, OLAX230V-1080794, OLAX240, OLAX240E-1080795, OLAX240E-1080796, OLAX240V-1080797, OLAX240V-1080798, OLAX250, OLAX250E-1080760, OLAX250E-1080761, OLAX250V-1080765, OLAX250V-1080766, OLAX300, OLAX300E-1080770, OLAX300E-1080771, OLAX300E-1081033, OLAX300E-1081035, OLAX300E-1081036, OLAX300LC, OLAX300LCE-1081034, OLAX300V-1080775, OLAX300V-1080776, OLAX310, OLAX310E-1081110, OLAX310E-1081111, OLAX310LC, OLAX310LCE-1081114, OLAX310LCE-1081115...(Other models you can see in the webshop)		

			
GEV No.	541062	Ref. No.	6A021900 BN6A021900
description	manometer ø 63mm pressure range 0 up to 1bar connection marking adjustable kettle thread 1/4"		
For models:	910PGB-1191800, 910PGB-191800, 911PEB-1192805, 911PGB-1191805, 911RPEB-1392890, 911RPG-1391830, 915PEB-1192800		
spare parts for	541062		
	GEV No.	541130	Ref. No.
			—
	 glass panel ø 58mm thickness 2mm		



dosing pumps

membrane dosing pumps

self-priming

LANG

accessories

			
GEV No.	101286	Ref. No.	LA62070023 LAR62070023
description	olive ID ø 6mm Qty 1 pcs		
accessories for	101286		
	GEV No.	100909	Ref. No.
			LA62060223 LAR62060223
	 union screw thread M10x1 for pipe ø 6mm Qty 1 pcs		
	GEV No.	101464	Ref. No.
			—
	 union nut thread M12x1 for pipe ø 6mm		

accessories

container filters with non-return valve

			
GEV No.	361058	Ref. No.	LA65110650 LAR65110650
description	container filter with non-return valve SS hose ø 4x6mm ø 20mm L 56mm		
For models:	CKEP06, CKEP06B, CKEP10, CKEP10B, CKEP20, CKEP20B, CKEP21, CKEP21B, CKEP40, CKEP40B, CKET06, CKET06B, CKET10, CKET10B, CKET20, CKET20B, CKET21, CKET21B, CKET40, CKET40B, CKGP06, CKGP06B, CKGP10, CKGP10B, CKGP20, CKGP20B, CKGP21, CKGP21B, CKGP40, CKGP40B, CKGT06, CKGT06B, CKGT10, CKGT10B, CKGT20, CKGT20B, CKGT21, CKGT21B, CKGT40, CKGT40B		

mechanical components, equipment accessories

hoses

industrial hoses

PE hoses



GEV No.	520973	Ref. No.	LA80150000 LAR80150000 R70070040
description	hose John Guest thickness 1.5mm LLDPE blue ID ø 7mm ED ø 10mm		
For models:	CCG071M, CCG101M, CCG102M, CKEP06, CKEP06B, CKEP10, CKEP10B, CKEP20, CKEP20B, CKEP21, CKEP21B, CKEP40, CKEP40B, CKET06, CKET06B, CKET10, CKET10B, CKET20, CKET20B, CKET21, CKET21B, CKET40, CKET40B, CKGP06, CKGP06B, CKGP10, CKGP10B, CKGP20, CKGP20B, CKGP21, CKGP21B, CKGP40, CKGP40B, CKGT06, CKGT06B, CKGT10, CKGT10B, CKGT20, CKGT20B, CKGT21, CKGT21B, CKGT40, CKGT40B		

accessories for	520973			
	GEV No.	440564	Ref. No.	—
	push-in fitting John Guest straight thread 1/4" BSP pipe connection ø10mm			
	GEV No.	440565	Ref. No.	—
	push-in fitting John Guest straight thread 3/8" BSP pipe connection ø10mm			
	GEV No.	440608	Ref. No.	—
	push-in fitting John Guest straight thread 1/2" BSP stub ø 10mm			
	GEV No.	440639	Ref. No.	—
	push-in fitting John Guest angled thread 1/4" BSP pipe connection ø10mm			
	GEV No.	520359	Ref. No.	LA62090528 LAR62090528 R62090528
	push-in fitting John Guest angled pipe connection ø10mm grommet ø 10mm			
	GEV No.	520363	Ref. No.	R62090468
	push-in fitting John Guest T-piece pipe connection ø10mm - ø10mm - ø10mm			
	GEV No.	520494	Ref. No.	LA62090478 LAR62090478 R62090478
	push-in fitting John Guest angled pipe connection ø10mm - ø10mm			

PU hoses



GEV No.	512505	Ref. No.	LA80150020 LAR80150020
description	PU hose ID ø 5mm ED ø 8mm L 1m thickness 1.5mm t.max. -40 up to +60°C polyurethane transparent/colourless		

PVC hoses

PVC hoses without fabric



GEV No.	520278	Ref. No.	R70070100
description	PVC hose ID ø 6mm ED ø 8mm L 2m thickness 1mm t.max. 60°C transparent		
For models:	CKEP06, CKEP06B, CKEP10, CKEP10B, CKEP20, CKEP20B, CKEP21, CKEP21B, CKEP40, CKEP40B, CKET06, CKET06B, CKET10, CKET10B, CKET20, CKET20B, CKET21, CKET21B, CKET40, CKET40B, CKGP06, CKGP06B, CKGP10, CKGP10B, CKGP20, CKGP20B, CKGP21, CKGP21B, CKGP40, CKGP40B, CKGT06, CKGT06B, CKGT10, CKGT10B, CKGT20, CKGT20B, CKGT21, CKGT21B, CKGT40, CKGT40B		

silicone hoses

without fabric



GEV No.	530899	Ref. No.	LAR70060080
description	silicone hose ID ø 13mm ED ø 18mm L 0.08m thickness 2.5mm red for combi-steamer		
For models:	CKEP06, CKEP06B, CKEP10, CKEP10B, CKEP20, CKEP20B, CKEP21, CKEP21B, CKEP40, CKEP40B, CKET06, CKET06B, CKET10, CKET10B, CKET20, CKET20B, CKET21, CKET21B, CKET40, CKET40B, CKGP06, CKGP06B, CKGP10, CKGP10B, CKGP20, CKGP20B, CKGP21, CKGP21B, CKGP40, CKGP40B, CKGT06, CKGT06B, CKGT10, CKGT10B, CKGT20, CKGT20B, CKGT21, CKGT21B, CKGT40, CKGT40B		

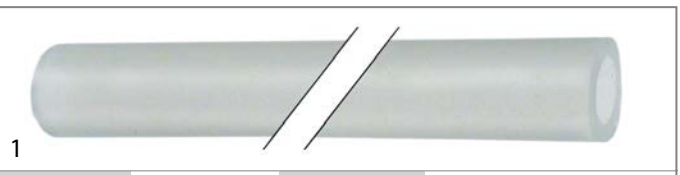

GEV No.	570157	Ref. No.	LA80120060 LAR80120060 R70070090
description	silicone hose ID ø 7mm ED ø 12mm L 1m thickness 2.5mm transparent for combi-steamer		
For models:	CKEP06, CKEP06B, CKEP10, CKEP10B, CKEP20, CKEP20B, CKEP21, CKEP21B, CKEP40, CKEP40B, CKET06, CKET06B, CKET10, CKET10B, CKET20, CKET20B, CKET21, CKET21B, CKET40, CKET40B, CKGP06, CKGP06B, CKGP10, CKGP10B, CKGP20, CKGP20B, CKGP21, CKGP21B, CKGP40, CKGP40B, CKGT06, CKGT06B, CKGT10, CKGT10B, CKGT20, CKGT20B, CKGT21, CKGT21B, CKGT40, CKGT40B		



formed hoses

straight



1

GEV No.	520534	Ref. No.	LA70060040 LAR70060040
description	hose ID ø 50mm ED ø 58mm L 50mm silicone Qty 1 for combi-steamer thickness 4mm		
For models:	CKEP06, CKEP06B, CKEP10, CKEP10B, CKEP20, CKEP20B, CKEP21, CKEP21B, CKEP40, CKEP40B, CKET06, CKET06B, CKET10, CKET10B, CKET20, CKET20B, CKET21, CKET21B, CKET40, CKET40B, CKGP06, CKGP06B, CKGP10, CKGP10B, CKGP20, CKGP20B, CKGP21, CKGP21B, CKGP40, CKGP40B, CKGT06, CKGT06B, CKGT10, CKGT10B, CKGT20, CKGT20B, CKGT21, CKGT21B, CKGT40, CKGT40B		



1

GEV No.	530901	Ref. No.	LA70060050 R70060050
description	hose ID ø 54mm ED ø 60mm L 50mm for combi-steamer		
For models:	CKEP20, CKEP20B, CKEP40, CKEP40B, CKET20, CKET20B, CKET40, CKET40B, CKGP40, CKGP40B, CKGT40, CKGT40B		



1

GEV No.	592327	Ref. No.	LA80150060 LAR80150060
description	water hose ID ø 7mm ext. ø 10 L 1000mm operating p. 3bar temp.-resist. 92°C for combi-steamer		

fittings, hose and pipe connectors

hose connectors

without screw connection



1

GEV No.	501210	Ref. No.	540090
description	Y-piece plastic hose ø 10-10-10mm		
For models:	OLDerby, OLDS35, OLDS35-1081005, OLDS35-1081061, OLDS35D-1081062, OLDS35-Neutra, OLDS37, OLDS37-1081063, OLDS37D-1081064, OLDS37-Neutra, OLDS40, OLDS40-1081010, OLDS40-1081065, OLDS40D-1081011, OLDS40D-1081066, OLDS40E-1081067, OLDS40ED-1081068, OLDS40LS-1081012, OLDS40LSD-1081013, OLDS40-Neutra, OLElectron400, OLG35, OLG35-1080702, OLG35D-1081000, OLG35-Neutra, OLGastro450, OLG37, OLG37-1080700, OLG37D-1080707, OLG37LS-1081001, OLG37LSD-1081002, OLG37-Neutra, OLG540, OLG540, OLG540-1080701, OLG540D-1080708, OLG540D-1081003, OLG540-Neutra, OLG540LSD-1081004, OLHT-11-Neutra, OLLinear		

fittings

double nipples



1

GEV No.	521182	Ref. No.	LA62020118 LAR62020118
description	double nipple plastic thread 1/4" - 1/4" Qty 1 pcs		



reducers



GEV No.	520177	Ref. No.	12032
description	reducer thread 1/4" ET - 1/8" IT nickel-plated brass total length 13mm WS 17		
For models:	OLAX151, OLAX151EDX-1080725, OLAX151ELEFT-1080727, OLAX151-highspeed, OLAX160, OLAX160E-1080750, OLAX160E-1080751, OLAX160V-1080755, OLAX160V-1080756, OLAX160V-1081031, OLAX160V-1081032, OLAX210, OLAX210E-1081029, OLAX210E-1081030, OLAX220, OLAX220E-1080787, OLAX220E-1080788, OLAX220V-1080789, OLAX220V-1080790, OLAX230, OLAX230E-1080791, OLAX230E-1080792, OLAX230V-1080793, OLAX230V-1080794, OLAX240, OLAX240E-1080795, OLAX240E-1080796, OLAX240V-1080797, OLAX240V-1080798, OLAX250, OLAX250E-1080760, OLAX250E-1080761, OLAX250V-1080765, OLAX250V-1080766, OLAX300, OLAX300E-1080770, OLAX300E-1080771, OLAX300E-1081033, OLAX300E-1081035, OLAX300E-1081036, OLAX300LC, OLAX300LCE-1081034, OLAX300V-1080775, OLAX300V-1080776, OLAX310, OLAX310E-1081110, OLAX310E-1081111, OLAX310LC, OLAX310LCE-1081114, OLAX310LCE-1081115...(Other models you can see in the webshop)		

screw pipe fittings

angle pieces



GEV No.	699452	Ref. No.	LA62090633 LAR62090633
description	angle piece thread M14x1 tube ø 10mm brass		
For models:	CKEP06, CKEP06B, CKEP10, CKEP10B, CKEP20, CKEP20B, CKEP21, CKEP21B, CKEP40, CKEP40B, CKET06, CKET06B, CKET10, CKET10B, CKET20, CKET20B, CKET21, CKET21B, CKET40, CKET40B, CKGP06, CKGP06B, CKGP10, CKGP10B, CKGP20, CKGP20B, CKGP21, CKGP21B, CKGP40, CKGP40B, CKGT06, CKGT06B, CKGT10, CKGT10B, CKGT20, CKGT20B, CKGT21, CKGT21B, CKGT40, CKGT40B		

hose connectors

plastic



GEV No.	362015	Ref. No.	LAR62090638
description	hose connector plastic straight IT 1/4" hose ø 8mm		



GEV No.	362011	Ref. No.	R62090538
description	hose connector plastic straight thread 1/4" hose ø 8x6mm Qty 1 pcs		
For models:	CKEP06, CKEP06B, CKEP10, CKEP10B, CKEP20, CKEP20B, CKEP21, CKEP21B, CKEP40, CKEP40B, CKET06, CKET06B, CKET10, CKET10B, CKET20, CKET20B, CKET21, CKET21B, CKET40, CKET40B, CKGP06, CKGP06B, CKGP10, CKGP10B, CKGP20, CKGP20B, CKGP21, CKGP21B, CKGP40, CKGP40B, CKGT06, CKGT06B, CKGT10, CKGT10B, CKGT20, CKGT20B, CKGT21, CKGT21B, CKGT40, CKGT40B		

nickel-plated brass



GEV No.	520201	Ref. No.	12005
description	hose connector nickel-plated brass straight thread 1/4" hose ø 12mm Qty 1 pcs		
For models:	OLAX151, OLAX151EDX-1080725, OLAX151ELEFT-1080727, OLAX151-highspeed, OLAX160, OLAX160E-1080750, OLAX160E-1080751, OLAX160V-1080755, OLAX160V-1080756, OLAX160V-1081031, OLAX160V-1081032, OLAX210, OLAX210E-1081029, OLAX210E-1081030, OLAX220, OLAX220E-1080787, OLAX220E-1080788, OLAX220V-1080789, OLAX220V-1080790, OLAX230, OLAX230E-1080791, OLAX230E-1080792, OLAX230V-1080793, OLAX230V-1080794, OLAX240, OLAX240E-1080795, OLAX240E-1080796, OLAX240V-1080797, OLAX240V-1080798, OLAX250, OLAX250E-1080760, OLAX250E-1080761, OLAX250V-1080765, OLAX250V-1080766, OLAX300, OLAX300E-1080770, OLAX300E-1080771, OLAX300E-1081033, OLAX300E-1081035, OLAX300E-1081036, OLAX300LC, OLAX300LCE-1081034, OLAX300V-1080775, OLAX300V-1080776, OLAX310, OLAX310E-1081110, OLAX310E-1081111, OLAX310LC, OLAX310LCE-1081114, OLAX310LCE-1081115...(Other models you can see in the webshop)		

stainless steel



GEV No.	542385	Ref. No.	LA62090663 LAR62090663
description	hose connector SS angled thread 1/4" hose ø 10mm Qty 1 pcs		

producer-specific





GEV No.	440027	Ref. No.	LA62090482 LAR62090482
description	connecting piece for hose ID 6mm WS 15 total length 79mm plastic John Guest		
For models:	CKEP06, CKEP06B, CKEP10, CKEP10B, CKEP20, CKEP20B, CKEP21, CKEP21B, CKEP40, CKEP40B, CKET06, CKET06B, CKET10, CKET10B, CKET20, CKET20B, CKET21, CKET21B, CKET40, CKET40B, CKGP06, CKGP06B, CKGP10, CKGP10B, CKGP20, CKGP20B, CKGP21, CKGP21B, CKGP40, CKGP40B, CKGT06, CKGT06B, CKGT10, CKGT10B, CKGT20, CKGT20B, CKGT21, CKGT21B, CKGT40, CKGT40B		



			
1			
GEV No.	520339	Ref. No.	LA62090518 LAR62090518
description	hose connector thread 1/4" straight grommet ø10mm grommet length 20mm WS 20 total length 37mm thread L 11mm plastic		
For models:	CKEP06, CKEP06B, CKEP10, CKEP10B, CKEP20, CKEP20B, CKEP21, CKEP21B, CKEP40, CKEP40B, CKET06, CKET06B, CKET10, CKET10B, CKET20, CKET20B, CKET21, CKET21B, CKET40, CKET40B, CKGP06, CKGP06B, CKGP10, CKGP10B, CKGP20, CKGP20B, CKGP21, CKGP21B, CKGP40, CKGP40B, CKGT06, CKGT06B, CKGT10, CKGT10B, CKGT20, CKGT20B, CKGT21, CKGT21B, CKGT40, CKGT40B		

			
2			
GEV No.	520360	Ref. No.	LAR62090508
description	hose connector thread 1/4" with coupling straight plastic		
For models:	CCE102M, CKEP06, CKEP06B, CKEP10, CKEP10B, CKEP20, CKEP20B, CKEP21, CKEP21B, CKEP40, CKEP40B, CKET06, CKET06B, CKET10, CKET10B, CKET20, CKET20B, CKET21, CKET21B, CKET40, CKET40B, CKGP06, CKGP06B, CKGP10, CKGP10B, CKGP20, CKGP20B, CKGP21, CKGP21B, CKGP40, CKGP40B, CKGT06, CKGT06B, CKGT10, CKGT10B, CKGT20, CKGT20B, CKGT21, CKGT21B, CKGT40, CKGT40B		

			
1			
GEV No.	440671	Ref. No.	LA62090678 LAR62090678 R62090648
description	push-in fitting John Guest angled pipe connection ø8mm grommet ø 8mm		
For models:	CKEP06, CKEP06B, CKEP10, CKEP10B, CKEP20, CKEP20B, CKEP21, CKEP21B, CKEP40, CKEP40B, CKET06, CKET06B, CKET10, CKET10B, CKET20, CKET20B, CKET21, CKET21B, CKET40, CKET40B, CKGP06, CKGP06B, CKGP10, CKGP10B, CKGP20, CKGP20B, CKGP21, CKGP21B, CKGP40, CKGP40B, CKGT06, CKGT06B, CKGT10, CKGT10B, CKGT20, CKGT20B, CKGT21, CKGT21B, CKGT40, CKGT40B		
accessories for	440671		
	GEV No.	520972	Ref. No. —
	 hose John Guest thickness 1mm LLDPE blue ID ø 6mm ED ø 8mm		

			
1			
GEV No.	520493	Ref. No.	R62090618
description	hose connector John Guest straight pipe connection ø8mm - ø10mm L 41mm PM201008E NSF, SK		
For models:	CKEP06, CKEP06B, CKEP10, CKEP10B, CKEP20, CKEP20B, CKEP21, CKEP21B, CKEP40, CKEP40B, CKET06, CKET06B, CKET10, CKET10B, CKET20, CKET20B, CKET21, CKET21B, CKET40, CKET40B, CKGP06, CKGP06B, CKGP10, CKGP10B, CKGP20, CKGP20B, CKGP21, CKGP21B, CKGP40, CKGP40B, CKGT06, CKGT06B, CKGT10, CKGT10B, CKGT20, CKGT20B, CKGT21, CKGT21B, CKGT40, CKGT40B		



			
1			
GEV No.	520492	Ref. No.	LA62090458 LAR62090458
description	push-in fitting John Guest straight pipe connection ø10mm - ø10mm		
For models:	CCE042M, CCE051M, CCE071M, CCE101M, CCG051M, CCG071M, CCG101M, CCG102M, CKEP06, CKEP06B, CKEP10, CKEP10B, CKEP20, CKEP20B, CKEP21, CKEP21B, CKEP40, CKEP40B, CKET06, CKET06B, CKET10, CKET10B, CKET20, CKET20B, CKET21, CKET21B, CKET40, CKET40B, CKGP06, CKGP06B, CKGP10, CKGP10B, CKGP20, CKGP20B, CKGP21, CKGP21B, CKGP40, CKGP40B, CKGT06, CKGT06B, CKGT10, CKGT10B, CKGT20, CKGT20B, CKGT21, CKGT21B, CKGT40, CKGT40B		

push-in fittings

JOHN GUEST

			
1			
GEV No.	520359	Ref. No.	LA62090528 LAR62090528
description	push-in fitting John Guest angled pipe connection ø10mm grommet ø 10mm		
For models:	CKEP06, CKEP06B, CKEP10, CKEP10B, CKEP20, CKEP20B, CKEP21, CKEP21B, CKEP40, CKEP40B, CKET06, CKET06B, CKET10, CKET10B, CKET20, CKET20B, CKET21, CKET21B, CKET40, CKET40B, CKGP06, CKGP06B, CKGP10, CKGP10B, CKGP20, CKGP20B, CKGP21, CKGP21B, CKGP40, CKGP40B, CKGT06, CKGT06B, CKGT10, CKGT10B, CKGT20, CKGT20B, CKGT21, CKGT21B, CKGT40, CKGT40B		
accessories for	520359		
	GEV No.	520973	Ref. No. LA80150000 LAR80150000 R70070040
	 hose John Guest thickness 1.5mm LLDPE blue ID ø 7mm ED ø 10mm		



			
GEV No.	520494	Ref. No.	LA62090478 LAR62090478
description	push-in fitting John Guest angled pipe connection ϕ 10mm - ϕ 10mm		
For models:	CCE042M, CCE051M, CCE071M, CCE101M, CCE102M, CCG051M, CCG071M, CCG101M, CCG102M, CKEP06, CKEP06B, CKEP10, CKEP10B, CKEP20, CKEP20B, CKEP21, CKEP21B, CKEP40, CKEP40B, CKET06, CKET06B, CKET10, CKET10B, CKET20, CKET20B, CKET21, CKET21B, CKET40, CKET40B, CKGP06, CKGP06B, CKGP10, CKGP10B, CKGP20, CKGP20B, CKGP21, CKGP21B, CKGP40, CKGP40B, CKGT06, CKGT06B, CKGT10, CKGT10B, CKGT20, CKGT20B, CKGT21, CKGT21B, CKGT40, CKGT40B		
accessories for	520494		
			
GEV No.	520973	Ref. No.	LA80150000 LAR80150000 R70070040
hose John Guest thickness 1.5mm LLDPE blue ID ϕ 7mm ED ϕ 10mm			

			
GEV No.	440031	Ref. No.	LA62090688 LAR62090688
description	push-in fitting John Guest straight thread 1/2" pipe connection ϕ 8mm - ϕ 8mm bulkhead connector		

valves and tank inlets

ball valves



universal



ball valves with butterfly handle

			
GEV No.	540658	Ref. No.	1450500
description	ball valve connection 3/4" IT - 3/4" IT DN20 total length 69mm		
For models:	CPE60, CPE60DB, OCPE60, OCPE-60-12601900, OCPE-60-12601900MN		

ball valves electric

			
GEV No.	403042	Ref. No.	R65110560
description	ball valve inlet 3/4" IT outlet 3/4" IT 230V L 68mm closed off-current mode of operation electric connection cable 400mm		
For models:	CKEP06B, CKEP10B, CKEP20B, CKEP21B, CKEP40B, CKET06B, CKET10B, CKET20B, CKET21B, CKET40B, CKGP06B, CKGP10B, CKGP20B, CKGP21B, CKGP40B, CKGP40B, CKGT06B, CKGT10B, CKGT20B, CKGT21B, CKGT40B		

			
GEV No.	520363	Ref. No.	R62090468
description	push-in fitting John Guest T-piece pipe connection ϕ 10mm - ϕ 10mm - ϕ 10mm		
For models:	CKEP06, CKEP06B, CKEP10, CKEP10B, CKEP20, CKEP20B, CKEP21, CKEP21B, CKEP40, CKEP40B, CKET06, CKET06B, CKET10, CKET10B, CKET20, CKET20B, CKET21, CKET21B, CKET40, CKET40B, CKGP06, CKGP06B, CKGP10, CKGP10B, CKGP20, CKGP20B, CKGP21, CKGP21B, CKGP40, CKGP40B, CKGT06, CKGT06B, CKGT10, CKGT10B, CKGT20, CKGT20B, CKGT21, CKGT21B, CKGT40, CKGT40B		
accessories for	520363		
			
GEV No.	520973	Ref. No.	LA80150000 LAR80150000 R70070040
hose John Guest thickness 1.5mm LLDPE blue ID ϕ 7mm ED ϕ 10mm			

			
GEV No.	520495	Ref. No.	LA62090608 LAR62090608
description	push-in fitting John Guest straight thread 1/8" BSP stub ϕ 8mm		
For models:	CKEP06, CKEP06B, CKEP10, CKEP10B, CKEP20, CKEP20B, CKEP21, CKEP21B, CKEP40, CKEP40B, CKET06, CKET06B, CKET10, CKET10B, CKET20, CKET20B, CKET21, CKET21B, CKET40, CKET40B, CKGP06, CKGP06B, CKGP10, CKGP10B, CKGP20, CKGP20B, CKGP21, CKGP21B, CKGP40, CKGP40B, CKGT06, CKGT06B, CKGT10, CKGT10B, CKGT20, CKGT20B, CKGT21, CKGT21B, CKGT40, CKGT40B		
accessories for	520495		
			
GEV No.	520971	Ref. No.	—
hose thickness 1mm LLDPE blue ID ϕ 4mm ED ϕ 6mm operating pressure at 20°C 16bar			



			
1			
GEV No.	401190	Ref. No.	3103590 3198150 BN3103590 BN3198150
description	ball valve inlet 3/4" IT outlet 3/4" IT IP42 230V L 68mm 50/60Hz closed off-current mode of operation electric connection cable 300mm 3.5W duty cycle 50%		
For models:	CVP10E, CVP10E-1320700, CVP10E-1320710, CVP10E-2, CVP10E2-1320740, CVP10E2S-1320790, CVP10E-S, CVP10ES-1320750, CVP10ES-1320760, CVP10E-S2, CVP10G, CVP10G-1310700, CVP10G-1310750, CVP10G-2, CVP10G2-1310740, CVP10G-S, CVP10G-S2, CVP10GS2-1310790, CVP20E, CVP20E-1320800, CVP20E-2, CVP20E2-1320840, CVP20E-S, CVP20ES-1320850, CVP20E-S2, CVP20ES2-1320890, CVP20G, CVP20G-1310800, CVP20G-1310850, CVP20G-2, CVP20G-S, CVP20GS-1310840, CVP20G-S2, CVP20GS2-1310890, CVP21E, CVP21E-1322700, CVP21E-2, CVP21E-S, CVP21ES-1322750, CVP21E-S2, CVP21ES2-1322790, CVP21G, CVP21G-1312700, CVP21G-2, CVP21G2-1312740, CVP21G-S, CVP21GS-1312750, CVP21G-S2, CVP21GS2-1312790, CVP6E...(Other models you can see in the webshop)		

water cycle components

pressure reduction valves

pressure reduction valves

universal

			
1			
GEV No.	520967	Ref. No.	BN3103634
description	pressure reduction valve series HP WR01 connection 1/2" default setting 3bar setting range 1-6bar p max 16bar t.max. 40°C chrome-plated brass IMPORT		

ancillary products

thread sealants

			
1			
GEV No.	890097	Ref. No.	Loctite 577
description	thread sealing LOCTITE 577 medium-strength bottle 50ml pipe thread sealing t.max. 150°C approval BAM and DVGW		
description	LOCTITE® 577™ - bottle 50ml It is designed for the locking and sealing of metal pipes and fittings as well as other cylindrical metal assemblies. The product provides an instant, low-pressure seal for metal pipes and fittings. It will not creep, shrink or block systems by shredding. Suitable for fast application at low temperatures. It has excellent chemical and thermal resistance and offers less migration of liquid product after application to the part.		
For models:	OLAX151, OLAX151EDX-1080725, OLAX151ELEFT-1080727, OLAX151-highspeed, OLAX160, OLAX160E-1080750, OLAX160E-1080751, OLAX160V-1080755, OLAX160V-1080756, OLAX160V-1081031, OLAX160V-1081032, OLAX210, OLAX210E-1081029, OLAX210E-1081030, OLAX220, OLAX220E-1080787, OLAX220E-1080788, OLAX220V-1080789, OLAX220V-1080790, OLAX230, OLAX230E-1080791, OLAX230E-1080792, OLAX230V-1080793, OLAX230V-1080794, OLAX240, OLAX240E-1080795, OLAX240E-1080796, OLAX240V-1080797, OLAX240V-1080798, OLAX250, OLAX250E-1080760, OLAX250E-1080761, OLAX250V-1080765, OLAX250V-1080766, OLAX300, OLAX300E-1080770, OLAX300E-1080771, OLAX300E-1081033, OLAX300E-1081035, OLAX300E-1081036, OLAX300LC, OLAX300LCE-1081034, OLAX300V-1080775, OLAX300V-1080776, OLAX310, OLAX310E-1081110, OLAX310E-1081111, OLAX310LC, OLAX310LCE-1081114, OLAX310LCE-1081115...(Other models you can see in the webshop)		

clamps

hose clamps

DIN 3017 - W2

			
1			
GEV No.	520112	Ref. No.	11807 LAR61630011
description	hose clamp ø 12-20mm width 9mm Qty 10 pcs DIN 3017		
For models:	CKEP06, CKEP06B, CKEP10, CKEP10B, CKEP20, CKEP20B, CKEP21, CKEP21B, CKEP40, CKEP40B, CKET06, CKET06B, CKET10, CKET10B, CKET20, CKET20B, CKET21, CKET21B, CKET40, CKET40B, CKGP06, CKGP06B, CKGP10, CKGP10B, CKGP20, CKGP20B, CKGP21, CKGP21B, CKGP40, CKGP40B, CKGT06, CKGT06B, CKGT10, CKGT10B, CKGT20, CKGT20B, CKGT21, CKGT21B, CKGT40, CKGT40B, G12S, OLAX151, OLAX151EDX-1080725, OLAX151ELEFT-1080727, OLAX151-high-speed, OLAX160, OLAX160E-1080750, OLAX160E-1080751, OLAX160V-1080755, OLAX160V-1080756...(Other models you can see in the webshop)		



			
1			
GEV No.	520115	Ref. No.	11806
description	hose clamp ø 25-40mm width 9mm Qty 10 pcs DIN 3017		
For models:	OLAX151, OLAX151EDX-1080725, OLAX151LEFT-1080727, OLAX151-highspeed, OLAX160, OLAX160E-1080750, OLAX160E-1080751, OLAX160V-1080755, OLAX160V-1080756, OLAX160V-1081031, OLAX160V-1081032, OLAX210, OLAX210E-1081029, OLAX210E-1081030, OLAX220, OLAX220E-1080787, OLAX220E-1080788, OLAX220V-1080789, OLAX220V-1080790, OLAX230, OLAX230E-1080791, OLAX230E-1080792, OLAX230V-1080793, OLAX230V-1080794, OLAX240, OLAX240E-1080795, OLAX240E-1080796, OLAX240V-1080797, OLAX240V-1080798, OLAX250, OLAX250E-1080760, OLAX250E-1080761, OLAX250V-1080765, OLAX250V-1080766, OLAX300, OLAX300E-1080770, OLAX300E-1080771, OLAX300E-1081033, OLAX300E-1081035, OLAX300E-1081036, OLAX300LC, OLAX300LCE-1081034, OLAX300V-1080775, OLAX300V-1080776, OLAX310, OLAX310E-1081110, OLAX310E-1081111, OLAX310LC, OLAX310LCE-1081114, OLAX310LCE-1081115...(Other models you can see in the webshop)		

			
1			
GEV No.	560594	Ref. No.	BN6A006740 LA61020562 LAR61020562
description	hexagonal screw thread M6 thread L 20mm WS 10 total length 59mm		
For models:	CCE101M, CCE102M, CCG101M, CCG102M, CKEP10, CKEP10B, CKEP20, CKEP20B, CKEP21, CKEP21B, CKEP40, CKEP40B, CKET10, CKET10B, CKET20, CKET20B, CKET21, CKET21B, CKET40, CKET40B, CKGP10, CKGP10B, CKGP20, CKGP20B, CKGP21, CKGP21B, CKGP40, CKGP40B, CKGT10B, CKGT20, CKGT20B, CKGT21, CKGT21B, CKGT40, CKGT40B		

cylinder head bolts
DIN 912/ISO 4762

			
1			
GEV No.	520455	Ref. No.	R61030601
description	screw thread M8 thread L 20mm WS 6 SS Qty 1 pcs DIN 912/ISO 4762		
For models:	CKEP21, CKEP21B, CKEP40, CKEP40B, CKET21, CKET21B, CKET40, CKET40B, CKGP21, CKGP21B, CKGP40, CKGP40B, CKGT21, CKGT21B, CKGT40, CKGT40B		

grub screws
DIN 913/ISO 4026

			
1			
GEV No.	560024	Ref. No.	LA61090052 LAR61090052
description	grub screw thread M6 L 16mm SS DIN 913/ISO 4026 intake internal hexagon WS 3 Qty 20 pcs		
For models:	CKEP21, CKEP21B, CKEP40, CKEP40B, CKET21, CKET21B, CKET40, CKET40B, CKGP21, CKGP21B, CKGP40, CKGP40B, CKGT21, CKGT21B, CKGT40, CKGT40B		

fastening material

screws

raised countersunk head screws

			
1			
GEV No.	560541	Ref. No.	R61040272
description	raised countersunk head screw thread M6 thread L 13mm SS DIN 966/ISO 7047 Qty 1 pcs intake slotted head ø 11mm head thickness 5mm		
For models:	CKEP21, CKEP21B, CKEP40, CKEP40B, CKET21, CKET21B, CKET40, CKET40B, CKGP21, CKGP21B, CKGP40, CKGP40B, CKGT21, CKGT21B, CKGT40, CKGT40B		

hexagonal screws

			
1			
GEV No.	560087	Ref. No.	11104/B
description	hexagonal screw thread M6 thread L 16mm SS WS 10 Qty 20 pcs DIN 933 / ISO 4017		
For models:	OLLP1-S8, OLLP1-S8EL, OLLP2-1080742, OLLP-2PLUS, OLLP3-1080743, OLLP-3PLUS, OLLP4-1081258, OLLP-4PLUS		

DIN 916/ISO 4029			
			
1			
GEV No.	560173	Ref. No.	6A009190 BN6A009190
description	grub screw thread M4 L 10mm SS DIN 916/ISO 4029 intake internal hexagon WS 2 Qty 20 pcs		
For models:	72-02FRG-12700500, 72-02FRG17-12700505, 72-02FTG-12700130TA, 72-02FTGC-12700135TA, 72-02FTGR-12700132TA, 72-02TFTG-12730130TA, 72-02TFTGC-12730135TA, 72-02TFTGR-12730132TA, 73-02FRG-12700550, 74-02CGG-12700010, 74-02CGG-12700010TA, 74-02CTGG-12700180, 74-02CTGG-12700180TA, 74-02FRG-12700600, 74-02FRG17-12700605, 74-02FTG-12700140TA, 74-02FTG1-2R-12700141TA, 74-02FTGC-12700145TA, 74-02FTGR-12700142TA, 74-02TFTG-12730140TA, 74-02TFTG1-2R-12730141TA, 74-02TFTGC-12730145TA, 74-02TFTGR-12730142TA, 76-02CGFL-12700020, 76-02CGFL-12700020TA, 76-02CGG-12700015, 76-02CGG-12700015TA, 76-02CGGE-12700016, 76-02CGGE-12700016TA, 76-02CTGG-12700195, 76-02CTGG-12700195TA, 76-02CTGGE-12700196, 76-02CTGGE-12700196TA, 7FT-G400, 7FT-G410, 7FT-G800, 7FT-G810, 7FT-G820, 7FTTF-G800, 7FTTF-G805, 7FTTF-G820, 7FTTF-G825, 7FTTF-GE800, 7FTTF-GE805, 7FTTF-GE820, 7FTTF-GE825, 7FTT-G400, 7FTT-G405, 7FTT-G410, 7FTT-G415...(Other models you can see in the webshop)		

miscellaneous			
			
1			
GEV No.	690594	Ref. No.	LA58002560 LAR58002560
description	pressure screw for door hinge		
For models:	CKEP21, CKEP21B, CKEP40, CKEP40B, CKET21, CKET21B, CKET40, CKET40B, CKGP21, CKGP21B, CKGP40, CKGP40B, CKGT21, CKGT21B, CKGT40, CKGT40B		

			
1			
GEV No.	694991	Ref. No.	R58006400
description	screw thread M6 L 16mm for air baffle combi-steamer		
For models:	CCE042M, CCE051M, CCE071M, CCE101M, CCE102M, CCG051M, CCG071M, CCG101M, CCG102M		

nuts			
hexagonal nuts			
DIN 934 / ISO 4032/8673			
			
1			
GEV No.	560340	Ref. No.	11703
description	hexagonal nut thread M4 H 3.2mm WS 7 SS DIN/ISO DIN 934 / ISO 4032/8673 Qty 1 pcs		
For models:	OLDS35, OLDS35-1081061, OLDS35D-1081062, OLDS35-Neutra, OLDS37, OLDS37-1081063, OLDS37D-1081064, OLDS37-Neutra, OLDS40, OLDS40-1081065, OLDS40D-1081066, OLDS40E-1081067, OLDS40ED-1081068, OLDS40-Neutra, OLDS45, OLDS50, OLDS50-1081088, OLDS50D-1081089, OLDS50E-1081090, OLDS50ED-1081091, OLDS50-Neutra, OLG35, OLG35-1080702, OLG35D-1081000, OLG35-Neutra, OLG37, OLG37-1080700, OLG37D-1080707, OLG37LS-1081001, OLG37LSD-1081002, OLG37-Neutra, OLG540, OLG540-1080701, OLG540D-1080708, OLG540D-1081003, OLG540-Neutra, OLG540LSD-1081004		

			
1			
GEV No.	560197	Ref. No.	11719
description	nut thread M10 H 8mm WS 17 SS DIN/ISO DIN 934 / ISO 4032/8673 Qty 1 pcs		
For models:	OLAX151, OLAX151EDX-1080725, OLAX151ELEFT-1080727, OLAX151-highspeed, OLAX160, OLAX160E-1080750, OLAX160E-1080751, OLAX160V-1080755, OLAX160V-1080756, OLAX160V-1081031, OLAX160V-1081032, OLAX210, OLAX210E-1081029, OLAX210E-1081030, OLAX220, OLAX220E-1080787, OLAX220E-1080788, OLAX220V-1080789, OLAX220V-1080790, OLAX230, OLAX230E-1080791, OLAX230E-1080792, OLAX230V-1080793, OLAX230V-1080794, OLAX240, OLAX240E-1080795, OLAX240E-1080796, OLAX240V-1080797, OLAX240V-1080798, OLAX250, OLAX250E-1080760, OLAX250E-1080761, OLAX250V-1080765, OLAX250V-1080766, OLAX300, OLAX300E-1080770, OLAX300E-1080771, OLAX300E-1081033, OLAX300E-1081035, OLAX300E-1081036, OLAX300LC, OLAX300LCE-1081034, OLAX300V-1080775, OLAX300V-1080776, OLAX310, OLAX310E-1081110, OLAX310E-1081111, OLAX310LC, OLAX310LCE-1081114, OLAX310LCE-1081115...(Other models you can see in the webshop)		

			
1			
GEV No.	517174	Ref. No.	11702
description	nut thread M8 H 6.5mm WS 13 SS DIN/ISO DIN 934 / ISO 4032/8673 Qty 1 pcs		
For models:	G12S, OLAX151, OLAX151EDX-1080725, OLAX151ELEFT-1080727, OLAX151-highspeed, OLAX160, OLAX160E-1080750, OLAX160E-1080751, OLAX160V-1080755, OLAX160V-1080756, OLAX160V-1081031, OLAX160V-1081032, OLAX210, OLAX210E-1081029, OLAX210E-1081030, OLAX220, OLAX220E-1080787, OLAX220E-1080788, OLAX220V-1080789, OLAX220V-1080790, OLAX230, OLAX230E-1080791, OLAX230E-1080792, OLAX230V-1080793, OLAX230V-1080794, OLAX240, OLAX240E-1080795, OLAX240E-1080796, OLAX240V-1080797, OLAX240V-1080798, OLAX250, OLAX250E-1080760, OLAX250E-1080761, OLAX250V-1080765, OLAX250V-1080766, OLAX300, OLAX300E-1080770, OLAX300E-1080771, OLAX300E-1081033, OLAX300E-1081035, OLAX300E-1081036, OLAX300LC, OLAX300LCE-1081034, OLAX300V-1080775, OLAX300V-1080776, OLAX310, OLAX310E-1081110, OLAX310E-1081111, OLAX310LC, OLAX310LCE-1081114...(Other models you can see in the webshop)		

ISO 4033 / UNI5587



1

GEV No.	550866	Ref. No.	R58004020
description	nut thread M10x1.5 H 10mm SS WS 17 Qty 1 pcs DIN/ISO DIN 934 / ISO 4032/8673 left-hand thread		
For models:	CCE071M, CCG071M		

hexagonal nuts metric (without norm)



1

GEV No.	550681	Ref. No.	LA58004050 LAR58004050
description	nut thread M12x1.25 H 5mm WS 17 brass Qty 1 pcs		
For models:	CCE071M, CCE101M, CCE102M, CCG071M, CCG101M, CCG102M, CKEP06, CKEP06B, CKEP10, CKEP10B, CKEP20, CKEP20B, CKEP21, CKEP21B, CKEP40, CKEP40B, CKET06, CKET06B, CKET10, CKET10B, CKET20, CKET20B, CKET21, CKET21B, CKET40, CKET40B, CKGP06, CKGP06B, CKGP10, CKGP10B, CKGP20, CKGP20B, CKGP21, CKGP21B, CKGP40, CKGP40B, CKGT06, CKGT06B, CKGT10, CKGT10B, CKGT20, CKGT20B, CKGT21, CKGT21B, CKGT40, CKGT40B		



1

GEV No.	101345	Ref. No.	6A010820 BN6A010820
description	nut thread M15x1 H 3mm WS 19 brass Qty 1 pcs		
For models:	110-135CG, 110-135CG2P, 110-135CGE, 110-135CGE2P, 110-135CGEE, 110-135CGEE2P, 110-135CGEEP, 110-135CGEP, 110-135CGG, 110-135CGG2P, 110-135CGGE, 110-135CGGE2P, 110-135CGGEP, 110-135CGGP, 110-135CGP, 110-135TCG, 110-135TCG2P, 110-135TCGP, 110-45CBG, 110-45CG, 110-45CG1P, 110-45CGP, 110-45TCBG, 110-45TCG, 110-45TCG1P, 110-45TCGP, 110-90CG, 110-90CG1P, 110-90CGE, 110-90CGE1P, 110-90CGEP, 110-90CGG, 110-90CGG1P, 110-90CGGP, 110-90CGP, 110-90CTG, 110-90CTGE, 110-90CTGG, 110-90FTTG, 110-90FTTG1-2R, 110-90FTTGC, 110-90FTTGC1-2R, 110-90FTTGCR, 110-90FTTGE, 110-90FTTGG, 110-90FTTGR, 110-90TCG, 110-90TCG1P, 110-90TCGP, 110-90TCTG...(Other models you can see in the webshop)		



1

GEV No.	691289	Ref. No.	R58004830
description	nut thread M18x1 H 5mm WS 22 brass Qty 1 pcs for door handle		
For models:	CCE042M, CCE051M, CCE071M, CCE101M, CCE102M, CCG051M, CCG071M, CCG101M, CCG102M		



1

GEV No.	102067	Ref. No.	6A012300 939300 BN6A012300
description	nut thread M8x1 H 3mm brass Qty 1 pcs type SEF 1		
For models:	CFG101, CFG120, CFG70, OCFG101, OCFG-101-12600025, OCFG120, OCFG70, OCFG-70-12600000, OPGC-41-12600010		

washers

spring washers



1

GEV No.	697933	Ref. No.	R61420021
description	spring washer ID ø 13mm ED ø 24mm Qty 1 pcs		
For models:	CKEP21, CKEP21B, CKEP40, CKEP40B, CKET21, CKET21B, CKET40, CKET40B, CKGP21, CKGP21B, CKGP40, CKGP40B, CKGT21, CKGT21B, CKGT40, CKGT40B		



1

GEV No.	696397	Ref. No.	LAR61620091
description	spring washer ID ø 6.3mm ED ø 14mm Qty 1 pcs		
For models:	CKEP21, CKEP21B, CKEP40, CKEP40B, CKET21, CKET21B, CKET40, CKET40B, CKGP21, CKGP21B, CKGP40, CKGP40B, CKGT21, CKGT21B, CKGT40, CKGT40B		

washers

miscellaneous



1

GEV No.	691296	Ref. No.	R61400052
description	plain washer ID ø 10.5mm ED ø 21mm thickness 2mm SS Qty 1 pcs for fan wheel		
For models:	CCE071M, CCG071M, CKEP06, CKEP06B, CKET06, CKET06B, CKGP06, CKGP06B, CKGT06, CKGT06B		



1

GEV No.	691292	Ref. No.	R10401710
description	plain washer ID ø 12mm ED ø 17.5mm thickness 1mm SS Qty 1 pcs		
For models:	CCE071M, CCE101M, CCE102M, CCG071M, CCG101M, CCG102M, CKEP06, CKEP06B, CKEP10, CKEP10B, CKEP20, CKEP20B, CKET06, CKET06B, CKET10, CKET10B, CKET20, CKET20B, CKGP06, CKGP06B, CKGP10, CKGP10B, CKGP20, CKGP20B, CKGT06, CKGT06B, CKGT10, CKGT10B, CKGT20B		



			
1			
GEV No.	690593	Ref. No.	LA58002570 LAR58002570
description	plain washer ID ø 15mm ED ø 30mm thickness 3mm Qty 1 pcs for door hinge		
For models:	CKEP21, CKEP21B, CKEP40, CKEP40B, CKET21, CKET21B, CKET40, CKET40B, CKGP21, CKGP21B, CKGP40, CKGP40B, CKGT21, CKGT21B, CKGT40, CKGT40B		

			
1			
GEV No.	506160	Ref. No.	11185 11611
description	plain washer ID ø 8.6mm ED ø 16mm thickness 1.5mm SS Qty 1 pcs		
For models:	OLAX151, OLAX151EDX-1080725, OLAX151ELEFT-1080727, OLAX151-highspeed, OLAX160, OLAX160E-1080750, OLAX160E-1080751, OLAX160V-1080755, OLAX160V-1080756, OLAX160V-1081031, OLAX160V-1081032, OLAX210, OLAX210E-1081029, OLAX210E-1081030, OLAX220, OLAX220E-1080787, OLAX220E-1080788, OLAX220V-1080789, OLAX220V-1080790, OLAX230, OLAX230E-1080791, OLAX230E-1080792, OLAX230V-1080793, OLAX230V-1080794, OLAX240, OLAX240E-1080795, OLAX240E-1080796, OLAX240V-1080797, OLAX240V-1080798, OLAX250, OLAX250E-1080760, OLAX250E-1080761, OLAX250V-1080765, OLAX250V-1080766, OLAX300, OLAX300E-1080770, OLAX300E-1080771, OLAX300E-1081033, OLAX300E-1081035, OLAX300E-1081036, OLAX300LC, OLAX300LCE-1081034, OLAX300V-1080775, OLAX300V-1080776, OLAX310, OLAX310E-1081110, OLAX310E-1081111, OLAX310LC, OLAX310LCE-1081114, OLAX310LCE-1081115...(Other models you can see in the webshop)		

			
1			
GEV No.	551434	Ref. No.	LA58004010 LAR58004010
description	plain washer ø 30mm thickness 3mm hole ø 12.5mm for fan wheel combi-steamer		
For models:	CCE101M, CCE102M, CCG101M, CCG102M, CKEP10, CKEP10B, CKEP20, CKEP20B, CKEP21, CKEP21B, CKEP40, CKEP40B, CKET10, CKET10B, CKET20, CKET20B, CKET21, CKET21B, CKET40, CKET40B, CKGP10, CKGP10B, CKGP20, CKGP20B, CKGP21, CKGP21B, CKGP40, CKGP40B, CKGT10B, CKGT20, CKGT20B, CKGT21, CKGT21B, CKGT40, CKGT40B		

tooth lock washers			
DIN 6798A			
			
1			
GEV No.	560193	Ref. No.	15812699 MA15812699
description	tooth lock washer ID ø 10.4mm ED ø 18mm zinc-coated steel DIN/ISO DIN 6798A Qty 1 pcs for thread M10		
For models:	CPE60, CPE60DB, OCPE60, OCPE-60-12601900, OCPE-60-12601900MN		

fasteners

clamps

hose clamps

DIN 3017 - W2

			
1			
GEV No.	520112	Ref. No.	11807 LAR61630011
description	hose clamp ø 12-20mm width 9mm Qty 10 pcs DIN 3017		
For models:	CKEP06, CKEP06B, CKEP10, CKEP10B, CKEP20, CKEP20B, CKEP21, CKEP21B, CKEP40, CKEP40B, CKET06, CKET06B, CKET10, CKET10B, CKET20, CKET20B, CKET21, CKET21B, CKET40, CKET40B, CKGP06, CKGP06B, CKGP10, CKGP10B, CKGP20, CKGP20B, CKGP21, CKGP21B, CKGP40, CKGP40B, CKGT06, CKGT06B, CKGT10, CKGT10B, CKGT20, CKGT20B, CKGT21, CKGT21B, CKGT40, CKGT40B, G12S, OLAX151, OLAX151EDX-1080725, OLAX151ELEFT-1080727, OLAX151-high-speed, OLAX160, OLAX160E-1080750, OLAX160E-1080751, OLAX160V-1080755, OLAX160V-1080756...(Other models you can see in the webshop)		

GEV No.	520112	Ref. No.	11807 LAR61630011
description	hose clamp ø 12-20mm width 9mm Qty 10 pcs DIN 3017		
For models:	CKEP06, CKEP06B, CKEP10, CKEP10B, CKEP20, CKEP20B, CKEP21, CKEP21B, CKEP40, CKEP40B, CKET06, CKET06B, CKET10, CKET10B, CKET20, CKET20B, CKET21, CKET21B, CKET40, CKET40B, CKGP06, CKGP06B, CKGP10, CKGP10B, CKGP20, CKGP20B, CKGP21, CKGP21B, CKGP40, CKGP40B, CKGT06, CKGT06B, CKGT10, CKGT10B, CKGT20, CKGT20B, CKGT21, CKGT21B, CKGT40, CKGT40B, G12S, OLAX151, OLAX151EDX-1080725, OLAX151ELEFT-1080727, OLAX151-high-speed, OLAX160, OLAX160E-1080750, OLAX160E-1080751, OLAX160V-1080755, OLAX160V-1080756...(Other models you can see in the webshop)		

			
1			
GEV No.	520115	Ref. No.	11806
description	hose clamp ø 25-40mm width 9mm Qty 10 pcs DIN 3017		
For models:	OLAX151, OLAX151EDX-1080725, OLAX151ELEFT-1080727, OLAX151-highspeed, OLAX160, OLAX160E-1080750, OLAX160E-1080751, OLAX160V-1080755, OLAX160V-1080756, OLAX160V-1081031, OLAX160V-1081032, OLAX210, OLAX210E-1081029, OLAX210E-1081030, OLAX220, OLAX220E-1080787, OLAX220E-1080788, OLAX220V-1080789, OLAX220V-1080790, OLAX230, OLAX230E-1080791, OLAX230E-1080792, OLAX230V-1080793, OLAX230V-1080794, OLAX240, OLAX240E-1080795, OLAX240E-1080796, OLAX240V-1080797, OLAX240V-1080798, OLAX250, OLAX250E-1080760, OLAX250E-1080761, OLAX250V-1080765, OLAX250V-1080766, OLAX300, OLAX300E-1080770, OLAX300E-1080771, OLAX300E-1081033, OLAX300E-1081035, OLAX300E-1081036, OLAX300LC, OLAX300LCE-1081034, OLAX300V-1080775, OLAX300V-1080776, OLAX310, OLAX310E-1081110, OLAX310E-1081111, OLAX310LC, OLAX310LCE-1081114, OLAX310LCE-1081115...(Other models you can see in the webshop)		

GEV No.	520115	Ref. No.	11806
description	hose clamp ø 25-40mm width 9mm Qty 10 pcs DIN 3017		
For models:	OLAX151, OLAX151EDX-1080725, OLAX151ELEFT-1080727, OLAX151-highspeed, OLAX160, OLAX160E-1080750, OLAX160E-1080751, OLAX160V-1080755, OLAX160V-1080756, OLAX160V-1081031, OLAX160V-1081032, OLAX210, OLAX210E-1081029, OLAX210E-1081030, OLAX220, OLAX220E-1080787, OLAX220E-1080788, OLAX220V-1080789, OLAX220V-1080790, OLAX230, OLAX230E-1080791, OLAX230E-1080792, OLAX230V-1080793, OLAX230V-1080794, OLAX240, OLAX240E-1080795, OLAX240E-1080796, OLAX240V-1080797, OLAX240V-1080798, OLAX250, OLAX250E-1080760, OLAX250E-1080761, OLAX250V-1080765, OLAX250V-1080766, OLAX300, OLAX300E-1080770, OLAX300E-1080771, OLAX300E-1081033, OLAX300E-1081035, OLAX300E-1081036, OLAX300LC, OLAX300LCE-1081034, OLAX300V-1080775, OLAX300V-1080776, OLAX310, OLAX310E-1081110, OLAX310E-1081111, OLAX310LC, OLAX310LCE-1081114, OLAX310LCE-1081115...(Other models you can see in the webshop)		

consumables

sealants and adhesives

high temperature silicone



GEV No.	890059	Ref. No.	BN6A098350
description	high temperature silicone FERMITOPP 300 neutral curing -40 up to +265°C black cartridge 310ml		
description	<p>Fermitopp HN 300 - cartridge 310ml - black</p> <p>Is used for sealing expansion joints on heating flues, ovens, reactors, chimneys, stacks, etc. The sealant is neutrally cross-linking, reacts with the moisture in the air and is characterised by extremely good hot air-resistance. The adhesive surfaces must be dry, clean and free of loose parts and in the case of porous substrates they should, if necessary, be given a first coat of primer. Post-smoothing e.g. with soap solution must take place before skinning.</p> <p>Highly refractory, odourless, UV/water/colour/hot-air resistant</p> <p>Temperature range -50°C to +250°C</p>		

screw fixings



GEV No.	890137	Ref. No.	Loctite 243
description	screw fixing LOCTITE 243 medium-strength bottle 5ml		
description	<p>LOCTITE® 243™ - bottle 5ml</p> <p>Is a general purpose threadlocker of medium bond strength. This threadlocker secures and seal bolts, nuts and studs to prevent loosening due to vibration. The product works on all metals, including passive substrates such as stainless steel, aluminium and plated surfaces. It is proven to be tolerant of minor contamination due to industrial oils, e.g. engine oils, corrosion prevention oils and cutting fluids.</p>		
For models:	<p>OLAX151, OLAX151EDX-1080725, OLAX151ELEFT-1080727, OLAX151-highspeed, OLAX160, OLAX160E-1080750, OLAX160E-1080751, OLAX160V-1080755, OLAX160V-1080756, OLAX160V-1081031, OLAX160V-1081032, OLAX210, OLAX210E-1081029, OLAX210E-1081030, OLAX220, OLAX220E-1080787, OLAX220E-1080788, OLAX220V-1080789, OLAX220V-1080790, OLAX230, OLAX230E-1080791, OLAX230E-1080792, OLAX230V-1080793, OLAX230V-1080794, OLAX240, OLAX240E-1080795, OLAX240E-1080796, OLAX240V-1080797, OLAX240V-1080798, OLAX250, OLAX250E-1080760, OLAX250E-1080761, OLAX250V-1080765, OLAX250V-1080766, OLAX300, OLAX300E-1080770, OLAX300E-1080771, OLAX300E-1081033, OLAX300E-1081035, OLAX300E-1081036, OLAX300LC, OLAX300LCE-1081034, OLAX300V-1080775, OLAX300V-1080776, OLAX310, OLAX310E-1081110, OLAX310E-1081111, OLAX310LC, OLAX310LCE-1081114, OLAX310LCE-1081115...(Other models you can see in the webshop)</p>		

thread sealants



GEV No.	890097	Ref. No.	Loctite 577
description	thread sealing LOCTITE 577 medium-strength bottle 50ml pipe thread sealing t.max. 150°C approval BAM and DVGW		
description	<p>LOCTITE® 577™ - bottle 50ml</p> <p>It is designed for the locking and sealing of metal pipes and fittings as well as other cylindrical metal assemblies. The product provides an instant, low-pressure seal for metal pipes and fittings. It will not creep, shrink or block systems by shredding. Suitable for fast application at low temperatures. It has excellent chemical and thermal resistance and offers less migration of liquid product after application to the part.</p>		
For models:	<p>OLAX151, OLAX151EDX-1080725, OLAX151ELEFT-1080727, OLAX151-highspeed, OLAX160, OLAX160E-1080750, OLAX160E-1080751, OLAX160V-1080755, OLAX160V-1080756, OLAX160V-1081031, OLAX160V-1081032, OLAX210, OLAX210E-1081029, OLAX210E-1081030, OLAX220, OLAX220E-1080787, OLAX220E-1080788, OLAX220V-1080789, OLAX220V-1080790, OLAX230, OLAX230E-1080791, OLAX230E-1080792, OLAX230V-1080793, OLAX230V-1080794, OLAX240, OLAX240E-1080795, OLAX240E-1080796, OLAX240V-1080797, OLAX240V-1080798, OLAX250, OLAX250E-1080760, OLAX250E-1080761, OLAX250V-1080765, OLAX250V-1080766, OLAX300, OLAX300E-1080770, OLAX300E-1080771, OLAX300E-1081033, OLAX300E-1081035, OLAX300E-1081036, OLAX300LC, OLAX300LCE-1081034, OLAX300V-1080775, OLAX300V-1080776, OLAX310, OLAX310E-1081110, OLAX310E-1081111, OLAX310LC, OLAX310LCE-1081114, OLAX310LCE-1081115...(Other models you can see in the webshop)</p>		

cleaning agents

combisteamer detergents/descalers

Notice: Articles labelled 'DANGEROUS GOODS' are delivered by road through a forwarder for reasons of safety and are charged separately!



GEV No.	802039 ¹	Ref. No.	0331520 85150020 CR0331520 LA85150020
description	detergent for combi-steamer LAINOX Combi Clean 10 litres		
description	<p>LAINOX Combi Clean - detergent - canister 10l</p> <p>Triple-action alkaline detergent, specially designed for cleaning the cooking chambers of Lainox combi steamers. With its special 3-in-1 formula with detergent, rinse aid and descaler the detergent removes food residue and gives the cooking chamber a streak-free shine. The detergent helps ensure a long seal life. Can corrode metals.</p>		

¹DANGEROUS GOODS



fuses

fine fuses



GEV No.	358610	Ref. No.	15160
description	fine fuse size ø5x20mm 10A fast-acting rated 250V Qty 10 pcs		
For models:	OLAX151, OLAX151EDX-1080725, OLAX151ELEFT-1080727, OLAX151-highspeed, OLAX160, OLAX160E-1080750, OLAX160E-1080751, OLAX160V-1080755, OLAX160V-1080756, OLAX160V-1081031, OLAX160V-1081032, OLAX210, OLAX210E-1081029, OLAX210E-1081030, OLAX220, OLAX220E-1080787, OLAX220E-1080788, OLAX220V-1080789, OLAX220V-1080790, OLAX230, OLAX230E-1080791, OLAX230E-1080792, OLAX230V-1080793, OLAX230V-1080794, OLAX240, OLAX240E-1080795, OLAX240E-1080796, OLAX240V-1080797, OLAX240V-1080798, OLAX250, OLAX250E-1080760, OLAX250E-1080761, OLAX250V-1080765, OLAX250V-1080766, OLAX300, OLAX300E-1080770, OLAX300E-1080771, OLAX300E-1081033, OLAX300E-1081035, OLAX300E-1081036, OLAX300LC, OLAX300LCE-1081034, OLAX300V-1080775, OLAX300V-1080776, OLAX310, OLAX310E-1081110, OLAX310E-1081111, OLAX310LC, OLAX310LCE-1081114, OLAX310LCE-1081115...(Other models you can see in the webshop)		



GEV No.	358671	Ref. No.	15163
description	fine fuse size ø5x20mm 1A fast-acting rated 250V Qty 10 pcs		
For models:	OLAX151, OLAX151EDX-1080725, OLAX151ELEFT-1080727, OLAX151-highspeed, OLAX160, OLAX160E-1080750, OLAX160E-1080751, OLAX160V-1080755, OLAX160V-1080756, OLAX160V-1081031, OLAX160V-1081032, OLAX210, OLAX210E-1081029, OLAX210E-1081030, OLAX220, OLAX220E-1080787, OLAX220E-1080788, OLAX220V-1080789, OLAX220V-1080790, OLAX230, OLAX230E-1080791, OLAX230E-1080792, OLAX230V-1080793, OLAX230V-1080794, OLAX240, OLAX240E-1080795, OLAX240E-1080796, OLAX240V-1080797, OLAX240V-1080798, OLAX250, OLAX250E-1080760, OLAX250E-1080761, OLAX250V-1080765, OLAX250V-1080766, OLAX300, OLAX300E-1080770, OLAX300E-1080771, OLAX300E-1081033, OLAX300E-1081035, OLAX300E-1081036, OLAX300LC, OLAX300LCE-1081034, OLAX300V-1080775, OLAX300V-1080776, OLAX310, OLAX310E-1081110, OLAX310E-1081111, OLAX310LC, OLAX310LCE-1081114, OLAX310LCE-1081115...(Other models you can see in the webshop)		



GEV No.	358532	Ref. No.	R65200200
description	fine fuse size ø5x20mm 2A fast-acting rated 250V Qty 10 pcs		
For models:	CCE042M, CCE051M, CCE071M, CCE101M, CCE102M, CCG051M, CCG071M, CCG101M, CCG102M, CKEP06, CKEP06B, CKEP10, CKEP10B, CKEP20, CKEP20B, CKEP21, CKEP21B, CKEP40, CKEP40B, CKET06, CKET06B, CKET10, CKET10B, CKET20, CKET20B, CKET21, CKET21B, CKET40, CKET40B, CKGP06, CKGP06B, CKGP10, CKGP10B, CKGP20, CKGP20B, CKGP21, CKGP21B, CKGP40, CKGP40B, CKGT06, CKGT06B, CKGT10B, CKGT10B, CKGT20, CKGT20B, CKGT21, CKGT21B, CKGT40, CKGT40B		



GEV No.	358593	Ref. No.	R65200086
description	fine fuse size ø5x20mm 0.125A slow-acting rated 250V Qty 10 pcs		
For models:	CKEP06, CKEP06B, CKEP10, CKEP10B, CKEP20, CKEP20B, CKEP21, CKEP21B, CKEP40, CKEP40B, CKET06, CKET06B, CKET10, CKET10B, CKET20, CKET20B, CKET21, CKET21B, CKET40, CKET40B, CKGP06, CKGP06B, CKGP10, CKGP10B, CKGP20, CKGP20B, CKGP21, CKGP21B, CKGP40, CKGP40B, CKGT06, CKGT06B, CKGT10B, CKGT10B, CKGT20, CKGT20B, CKGT21, CKGT21B, CKGT40, CKGT40B		



GEV No.	358595	Ref. No.	R65200320
description	fine fuse size ø5x20mm 0.2A slow-acting rated 250V Qty 10 pcs		
For models:	CCE071M, CCE101M, CCE102M, CCG071M, CCG101M, CCG102M, CKEP06, CKEP06B, CKET06, CKET06B, CKGP06, CKGP06B, CKGT06, CKGT06B		



GEV No.	358703	Ref. No.	R65200350
description	fine fuse size ø5x20mm 0.4A slow-acting rated 250V Qty 10 pcs		
For models:	CKEP10, CKEP10B, CKEP20, CKEP20B, CKEP21, CKEP21B, CKEP40, CKEP40B, CKET10, CKET10B, CKET20, CKET20B, CKET21, CKET21B, CKET40, CKET40B, CKGP10, CKGP10B, CKGP20, CKGP20B, CKGP21, CKGP21B, CKGP40, CKGP40B, CKGT10B, CKGT20, CKGT20B, CKGT21, CKGT21B, CKGT40, CKGT40B		



GEV No.	358605	Ref. No.	6A001420 BN6A001420
description	fine fuse size ø5x20mm 3.15A slow-acting rated 250V Qty 10 pcs		
For models:	94-04PEI100L, 94-04PEI100L-12901765, 94-04PEI110L-12901765BN, 94-04PEI150L, 94-04PEI150L-12901767, 94-04PEI150L-12901767BN, 9PN-EI100, 9PN-EI150		



GEV No.	358609	Ref. No.	R65200240
description	fine fuse size ø5x20mm 5A slow-acting rated 250V Qty 10 pcs		
For models:	CKET06, CKET06B, CKGT06, CKGT06B		

A			
alarm devices	22		
audible timers	22		
axial fans	41		
B			
ball valves	102		
ball valves electric	39, 102		
ballasts	20		
bar burners	69		
bi-metal thermostats	6, 6		
booster pumps II	50		
C			
cable glands	53		
cables	53		
cam switches	13		
castors and bumper angles	89		
clamps	103, 107		
cleaning agents	108		
combisteamer detergents/descalers	108		
condensators & interference suppression filters	51		
consumables	108		
contactors	22		
container filters	97		
control equipment	16		
control thermostats	6		
cylinder head bolts	104		
D			
door seals	90		
door seals with fixing hook	94		
dosing pumps	97		
double nipples	99		
E			
electric accessories	53		
electrodes	40		
electronic controllers	32		
energy regulators	6		
espagnolette locks	83		
F			
fans	41		
fasteners	107		
fastening material	104		
ferrite rings	51		
filters	51		
fine fuses	109		
fittings	99		
fluorescent lamps	20		
forced air burners	70		
formed hoses	99		
fuses	52, 109		
G			
gas burners	69		
gas control valves	55		
gas nozzles	71		
gas thermostats	55		
gaskets for heated units	89		
gaskets for tray rack trolleys	94		
GEV	2		
grub screws	104		
H			
halogen lamp	20		
heating elements	2		
heating elements for convection	3		
hexagonal nuts	105		
hexagonal screws	104		
high temperature silicone	108		
hose clamps	103, 107		
hose connectors	99, 100		
hoses	98		
hot air fans	49		
hot air motors	42		
I			
ignition boxes	58		
ignition cables	65		
ignition units	66		
immersion heating elements	2		
indicator lights	18		
indicator lights (complete)	18		
industrial hoses	98		
L			
lamps	18		
M			
magnetic switches	15		
microswitches	11		
motors	50		
N			
nuts	105		
O			
operating capacitors	51		
O-rings	94		
oven hinges	86		
oven lamps	20		

P

PE hoses	98
pilot burners	59
pressure reduction valves	103, 103
pressure switches	40, 76
probes	32
programme timers	21
PU hoses	98
pumps	50
push/momentary push switches	10
push-in fittings	101
PVC hoses	98

R

radial fans	50
raised countersunk head screws	104
reducers	100
relays	28
rocker/momentary rocker switches	10

S

safety thermostats	8
screw fixings	108
screw pipe fittings	100
screws	104
sealants and adhesives	108
sealing washers	95
shaft gaskets	95
silicone	108
silicone hoses	98
solenoid valves	37
spring washers	106
switches and momentary switches	10
system switches (ROLD)	12

T

temperature probes	32
terminals	53
thermocouples	66
thermostats	6
thread sealants	76, 103, 108
threaded cable glands	53
time relays	30
timers	21
tooth lock washers	107
touch sensitive light switches	14
transformers	31

U

universal probes	32
------------------	----

V

valves and tank inlets	102
vibration pumps	51

W

washers	106
water cycle components	103
window seals	89